



# ***RX-V1000***

---

*Natural Sound AV Receiver*  
*Ampli-tuner audio-vidéo*

OWNER'S MANUAL  
MODE D'EMPLOI

# SAFETY INSTRUCTIONS

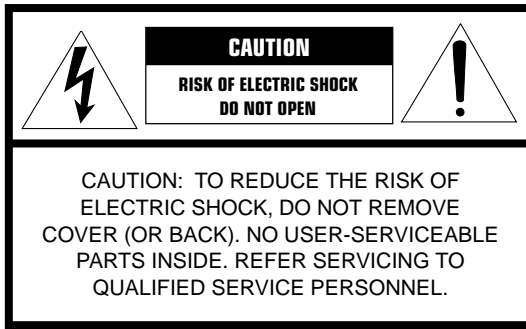

- Explanation of Graphical Symbols

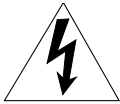

The lightning flash with arrowhead symbol, within an equilateral triangle, is intended to alert you to the presence of uninsulated "dangerous voltage" within the product's enclosure that may be of sufficient magnitude to constitute a risk of electric shock to persons.



The exclamation point within an equilateral triangle is intended to alert you to the presence of important operating and maintenance (servicing) instructions in the literature accompanying the appliance.

**WARNING**

**TO REDUCE THE RISK OF FIRE OR ELECTRIC SHOCK, DO NOT EXPOSE THIS UNIT TO RAIN OR MOISTURE.**

- 1 Read Instructions – All the safety and operating instructions should be read before the unit is operated.
- 2 Retain Instructions – The safety and operating instructions should be retained for future reference.
- 3 Heed Warnings – All warnings on the unit and in the operating instructions should be adhered to.
- 4 Follow Instructions – All operating and other instructions should be followed.
- 5 Water and Moisture – The unit should not be used near water – for example, near a bathtub, washbowl, kitchen sink, laundry tub, in a wet basement, or near a swimming pool, etc.
- 6 Carts and Stands – The unit should be used only with a cart or stand that is recommended by the manufacturer.
- 6A A unit and cart combination should be moved with care. Quick stops, excessive force, and uneven surfaces may cause the unit and cart combination to overturn.



- 7 Wall or Ceiling Mounting – The unit should be mounted to a wall or ceiling only as recommended by the manufacturer.
- 8 Ventilation – The unit should be situated so that its location or position does not interfere with its proper ventilation. For example, the unit should not be situated on a bed, sofa, rug, or similar surface, that may block the ventilation openings; or placed in a built-in installation, such as a bookcase or cabinet that may impede the flow of air through the ventilation openings.
- 9 Heat – The unit should be situated away from heat sources such as radiators, stoves, or other appliances that produce heat.
- 10 Power Sources – The unit should be connected to a power supply only of the type described in the operating instructions or as marked on the unit.
- 11 Power-Cord Protection – Power-supply cords should be routed so that they are not likely to be walked on or pinched by items placed upon or against them, paying particular attention to cords at plugs, convenience receptacles, and the point where they exit from the unit.
- 12 Cleaning – The unit should be cleaned only as recommended by the manufacturer.
- 13 Nonuse Periods – The power cord of the unit should be unplugged from the outlet when left unused for a long period of time.
- 14 Object and Liquid Entry – Care should be taken so that objects do not fall into and liquids are not spilled into the inside of the unit.
- 15 Damage Requiring Service – The unit should be serviced by qualified service personnel when:
  - A. The power-supply cord or the plug has been damaged; or
  - B. Objects have fallen, or liquid has been spilled into the unit; or
  - C. The unit has been exposed to rain; or
  - D. The unit does not appear to operate normally or exhibits a marked change in performance; or
  - E. The unit has been dropped, or the cabinet damaged.
- 16 Servicing – The user should not attempt to service the unit beyond those means described in the operating instructions. All other servicing should be referred to qualified service personnel.
- 17 Power Lines – An outdoor antenna should be located away from power lines.
- 18 Grounding or Polarization – Precautions should be taken so that the grounding or polarization is not defeated.

**19 For US customers only:**

Outdoor Antenna Grounding – If an outside antenna is connected to this unit, be sure the antenna system is grounded so as to provide some protection against voltage surges and built-up static charges. Article 810 of the National Electrical Code, ANSI/NFPA 70, provides information with regard to proper grounding of the mast and supporting structure, grounding of the lead-in wire to an antenna discharge unit, size of grounding conductors, location of antenna discharge unit, connection to grounding electrodes, and requirements for the grounding electrode.

**Note to CATV system installer:**

This reminder is provided to call the CATV system installer's attention to Article 820-40 of the NEC that provides guidelines for proper grounding and, in particular, specifies that the cable ground shall be connected to the grounding system of the building, as close to the point of cable entry as practical.

EXAMPLE OF ANTENNA GROUNDING

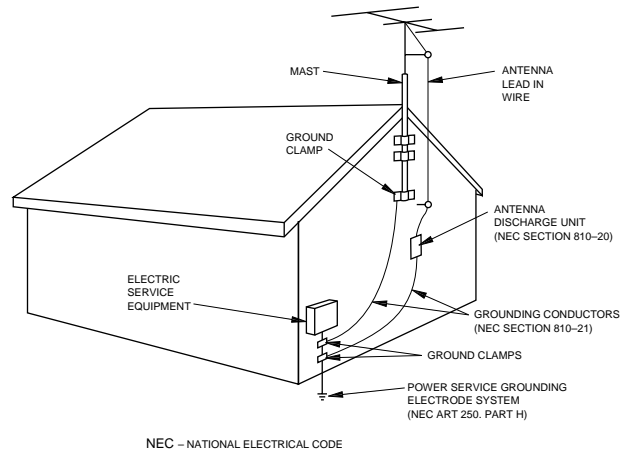
**FCC INFORMATION (for US customers only)****1. IMPORTANT NOTICE : DO NOT MODIFY THIS UNIT!**

This product, when installed as indicated in the instructions contained in this manual, meets FCC requirements. Modifications not expressly approved by Yamaha may void your authority, granted by the FCC, to use the product.

**2. IMPORTANT :** When connecting this product to accessories and/or another product use only high quality shielded cables. Cable/s supplied with this product **MUST** be used. Follow all installation instructions. Failure to follow instructions could void your FCC authorization to use this product in the USA.**3. NOTE :** This product has been tested and found to comply with the requirements listed in FCC Regulations, Part 15 for Class "B" digital devices. Compliance with these requirements provides a reasonable level of assurance that your use of this product in a residential environment will not result in harmful interference with other electronic devices. This equipment generates/uses radio frequencies and, if not installed and used according to the instructions found in the users manual, may cause interference harmful to the operation of other electronic devices.

Compliance with FCC regulations does not guarantee that interference will not occur in all installations. If this product is found to be the source of interference, which can be determined by turning the unit "OFF" and "ON", please try to eliminate the problem by using one of the following measures:

Relocate either this product or the device that is being affected by the interference.

Utilize power outlets that are on different branch (circuit breaker or fuse) circuits or install AC line filter/s.

In the case of radio or TV interference, relocate/reorient the antenna. If the antenna lead-in is 300 ohm ribbon lead, change the lead-in to coaxial type cable.

If these corrective measures do not produce satisfactory results, please contact the local retailer authorized to distribute this type of product. If you can not locate the appropriate retailer, please contact Yamaha Electronics Corp., U.S.A. 6660 Orangethorpe Ave, Buena Park, CA 90620.

The above statements apply **ONLY** to those products distributed by Yamaha Corporation of America or its subsidiaries.

**We Want You Listening For A Lifetime**

YAMAHA and the Electronic Industries Association's Consumer Electronics Group want you to get the most out of your equipment by playing it at a safe level. One that lets the sound come through loud and clear without annoying blaring or distortion – and, most importantly, without affecting your sensitive hearing.

Since hearing damage from loud sounds is often undetectable until it is too late, YAMAHA and the Electronic Industries Association's Consumer Electronics Group recommend you to avoid prolonged exposure from excessive volume levels.



# CAUTION: READ THIS BEFORE OPERATING YOUR UNIT.

- 1 To assure the finest performance, please read this manual carefully. Keep it in a safe place for future reference.
- 2 Install this unit in a well ventilated, cool, dry, clean place with at least 5 cm of ventilation space on the top, right and left, and at the back of this unit — away from direct sunlight, heat sources, vibration, dust, moisture, and/or cold.
- 3 Locate this unit away from other electrical appliances, motors, or transformers to avoid humming sounds. To prevent fire or electrical shock, do not place this unit where it may get exposed to rain, water, and/or any type of liquid.
- 4 Do not expose this unit to sudden temperature changes from cold to hot, and do not locate this unit in a environment with high humidity (i.e. a room with a humidifier) to prevent condensation inside this unit, which may cause an electrical shock, fire, damage to this unit, and/or personal injury.
- 5 On the top of this unit, do not place:
  - Other components, as they may cause damage and/or discoloration on the surface of this unit.
  - Buring objects (i.e. candles), as they may cause fire, damage to this unit, and/or personal injury.
  - Containers with liquid in them, as they may cause electrical shock to the user and/or damage to this unit.
- 6 Do not cover the rear panel of this unit with a newspaper, tablecloth, curtain, etc. in order not to obstruct heat radiation. If the temperature inside this unit rises, it may cause fire, damage to this unit, and/or personal injury.
- 7 Do not plug in this unit to a wall outlet until all connections are complete.
- 8 Do not operate this unit upside-down. It may overheat, possibly causing damage.
- 9 Do not use force on switches, knobs and/or cords.
- 10 When disconnecting the power cord from the wall outlet, grasp the plug; do not pull the cord.
- 11 Do not clean this unit with chemical solvents; this might damage the finish. Use a clean, dry cloth.
- 12 Only voltage specified on this unit must be used. Using this unit with a higher voltage than specified is dangerous and may cause fire, damage to this unit, and/or personal injury. YAMAHA will not be held responsible for any damage resulting from use of this unit with a voltage other than specified.
- 13 To prevent damage by lightning, disconnect the power cord from the wall outlet during an electrical storm.
- 14 Take care of this unit so that no foreign objects and/or liquid drops inside this unit.
- 15 Do not attempt to modify or fix this unit. Contact qualified YAMAHA service personnel when any service is needed. The cabinet should never be opened for any reasons.
- 16 When not planning to use this unit for long periods of time (i.e. vacation), disconnect the AC power plug from the wall outlet.
- 17 Be sure to read the “TROUBLESHOOTING” section on common operating errors before concluding that this unit is faulty.
- 18 Before moving this unit, press STANDBY/ON to set this unit in the standby mode, and disconnect the AC power plug from the wall outlet.
- 19 **VOLTAGE SELECTOR (China and general models only)**  
The VOLTAGE SELECTOR on the rear panel of this unit must be set for your local main voltage BEFORE plugging into the AC main supply. Voltages are 110/120/220/240 V AC, 50/60 Hz.

This unit is not disconnected from the AC power source as long as it is connected to the wall outlet, even if this unit itself is turned off. This state is called the standby mode. In this state, this unit is designed to consume a very small quantity of power.

## **FREQUENCY STEP switch (China and general models only)**

Because the interstation frequency spacing differs in different areas, set the FREQUENCY STEP switch (locating at the rear) according to the frequency spacing in your area.

North, Central and South America: 100 kHz/10 kHz

Other area: 50 kHz/9 kHz

Before setting this switch, disconnect the AC power plug of this unit from the AC outlet.

## **IMPORTANT**

Please record the serial number of this unit in the space below.

MODEL:

Serial No.:

The serial number is located on the rear of the unit.

Retain this Owner's Manual in a safe place for future reference.

## **FOR CANADIAN CUSTOMERS**

To prevent electric shock, match wide blade of plug to wide slot and fully insert.

This Class B digital apparatus complies with Canadian ICES-003.

# CONTENTS

## INTRODUCTION

<b>CONTENTS</b> .....	<b>1</b>
<b>FEATURES</b> .....	<b>2</b>
<b>GETTING STARTED</b> .....	<b>3</b>
Checking the Package Contents .....	3
Installing Batteries in the Remote Control .....	3
<b>CONTROLS AND FUNCTIONS</b> .....	<b>4</b>
Front Panel .....	4
Remote Control .....	6
Using the Remote Control .....	8
Front Panel Display .....	9
Rear Panel .....	10

## PREPARATION

<b>SPEAKER SETUP</b> .....	<b>11</b>
Speakers to Be Used .....	11
Speaker Placement .....	11
<b>CONNECTIONS</b> .....	<b>12</b>
Before Connecting Components .....	12
Connecting Audio Components .....	12
Connecting Video Components .....	14
Connecting the Speakers .....	16
Connecting to an External Amplifier .....	18
Connecting an External Decoder .....	18
IMPEDANCE SELECTOR Switch .....	19
Connecting the Power Supply Cords .....	19
<b>ON-SCREEN DISPLAY (OSD)</b> .....	<b>20</b>
OSD Modes .....	20
Selecting the OSD Mode .....	20
<b>SPEAKER MODE SETTINGS</b> .....	<b>21</b>
Summary of SPEAKER SET Items	
1A through 1F .....	21
<b>ADJUSTING THE SPEAKER</b>	
<b>OUTPUT LEVELS</b> .....	<b>22</b>
Before You Begin .....	22
Using the Test Tone (TEST DOLBY SUR.) .....	23

## BASIC OPERATION

<b>BASIC PLAYBACK</b> .....	<b>24</b>
Input Modes and Indications .....	26
Selecting a Sound Field Program .....	28
Normal Stereo Reproduction .....	29
<b>TUNING</b> .....	<b>30</b>
Connecting the Antennas .....	30
Automatic (or Manual) Tuning .....	31
Presetting Stations .....	32
Tuning in to a Preset Station .....	33
Exchanging Preset Stations .....	34
<b>BASIC RECORDING</b> .....	<b>35</b>

## ADVANCED OPERATION

<b>SET MENU</b> .....	<b>36</b>
Adjusting the Items on the SET MENU .....	36
1 SPEAKER SET (speaker mode settings) .....	37
2 LOW FRQ TEST .....	40
3 L/R BALANCE (balance of the left and	
right main speakers) .....	41
4 HP TONE CTRL (headphone tone control) .....	41
5 CENTER GEQ (center graphic equalizer) .....	41
6 INPUT RENAME .....	41
7 I/O ASSIGNMENT .....	41
8 INPUT MODE (initial input mode) .....	42
9 PARAM. INI (parameter initialization) .....	42
10 DOLBY D. SET (Dolby Digital set) .....	42
11 DTS LFE LEVEL .....	43
12 6.1/ES AUTO .....	43
13 SP DELAY TIME .....	43
14 DISPLAY SET .....	44
15 MEMORY GUARD .....	44
<b>ADJUSTING THE LEVEL OF THE EFFECT</b>	
<b>SPEAKERS</b> .....	<b>45</b>
<b>SLEEP TIMER</b> .....	<b>46</b>
Setting the Sleep Timer .....	46
Canceling the Sleep Timer .....	46
<b>REMOTE CONTROL FEATURES</b> .....	<b>47</b>
Control Area .....	47
Each Component Control Area .....	49
Setting the Manufacturer Code .....	54
Programming a New Remote Control Function	
(Learn Feature) .....	55
Using the Macro Feature .....	57
Changing the Source Name in	
the Display Window .....	59
Clearing a Learned Function or Macro .....	59
Clearing Learned Functions, Macros,	
Renamed Source Names, and	
Setup Manufacturer Codes .....	60
<b>ZONE 2</b> .....	<b>61</b>
Zone 2 Connections .....	61
Remote Control in Zone 2 .....	62

## ADDITIONAL INFORMATION

<b>SOUND FIELD PROGRAM</b> .....	<b>63</b>
Hi-Fi DSP Programs .....	63
CINEMA DSP Programs .....	64
MOVIE THEATER Programs .....	67
<b>SOUND FIELD PROGRAM PARAMETER</b>	
<b>EDITING</b> .....	<b>68</b>
What is a sound field? .....	68
Sound Field Program Parameters .....	68
Changing Parameter Settings .....	69
Resetting a Parameter to the Factory-set Value .....	69
Digital Sound Field Parameter Descriptions .....	70

## APPENDIX

<b>TROUBLESHOOTING</b> .....	<b>74</b>
<b>SPECIFICATIONS</b> .....	<b>79</b>

INTRODUCTION

PREPARATION

BASIC  
OPERATION

ADVANCED  
OPERATION

ADDITIONAL  
INFORMATION

APPENDIX

English

## FEATURES

### Built-in 5-Channel Power Amplifier

- ◆ Minimum RMS Output Power (0.04% THD, 20 Hz – 20 kHz)  
Main: 100 W + 100 W (8 Ω)  
Center: 100 W (8 Ω)  
Rear: 100 W + 100 W (8 Ω)
- ◆ Maximum Power (EIAJ) (10% THD, 1 kHz)  
[China and general models]  
Main: 140 W + 140 W (8 Ω)  
Center: 140 W (8 Ω)  
Rear: 140 W + 140 W (8 Ω)

### Multi-Mode Digital Sound Field Processing

- ◆ Digital Sound Field Processor (DSP)
- ◆ Dolby Pro Logic decoder
- ◆ Dolby Digital/Dolby Digital Matrix 6.1 Decoder
- ◆ DTS/DTS ES Decoder
- ◆ CINEMA DSP: Combination of YAMAHA DSP Technology and Dolby Pro Logic, Dolby Digital or DTS
- ◆ Virtual CINEMA DSP
- ◆ SILENT CINEMA DSP

### Sophisticated AM/FM Tuner

- ◆ 40-Station Random Access Preset Tuning
- ◆ Automatic Preset Tuning
- ◆ Preset Station Shifting Capability (Preset Editing)

### Other Features

- ◆ 96-kHz/24-bit D/A Converter
- ◆ “SET MENU” which Provides You with 15 Items for Optimizing This Unit for Your Audio/Video System
- ◆ Test Tone Generator for Easier Speaker Balance Adjustment
- ◆ 6-Channel External Decoder Input for Other Future Formats
- ◆ BASS EXTENSION Button for Reinforcing Bass Response
- ◆ On Screen Display Function Helpful in Controlling This Unit
- ◆ S Video Signal Input/Output Capability
- ◆ Component Video Input/Output Capability
- ◆ Optical and Coaxial Digital Audio Signal Jacks
- ◆ Sleep Timer
- ◆ Multi-Function Remote Control
- ◆ Custom Installation Facility

• ☀ indicates a tip for your operation.

• Some operations can be performed by using either the buttons on the main unit or on the remote control. In cases when the button names differ between the main unit and the remote control for such operations, the button name on the remote control is given in parentheses in this manual.



Manufactured under license from Dolby Laboratories. “Dolby”, “AC-3”, “Pro Logic”, “Surround EX” and the double-D symbol are trademarks of Dolby Laboratories. Confidential Unpublished Works. © 1992-1997 Dolby Laboratories, Inc. All rights reserved.



Manufactured under license from Digital Theater Systems, Inc. US Pat. No. 5,451,942 and other world-wide patents issued and pending. “DTS”, “DTS Digital Surround” and “DTS ES” are trademarks of Digital Theater Systems, Inc. Copyright 1996 Digital Theater Systems, Inc. All Rights Reserved.

# GETTING STARTED

## Checking the Package Contents

Check your package to make sure it has the following items.

### Remote control

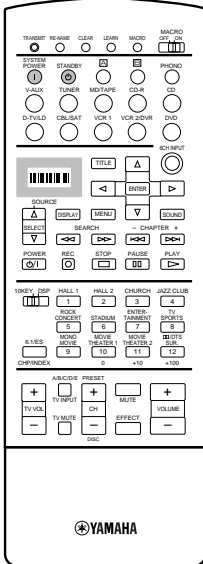

### Manganese batteries (3) (AA, R6, UM-3)

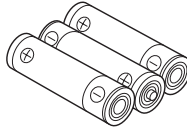

### AM loop antenna

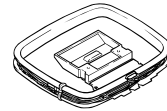

### Indoor FM antenna (U.S.A., Canada, China and general models)

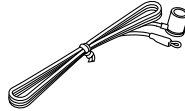

### (Australia and Singapore models)

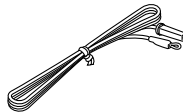

### Quick Reference Card

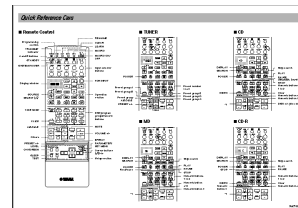

## Installing Batteries in the Remote Control

Insert the batteries in the correct direction by aligning the + and - marks on the batteries with the polarity markings (+ and -) inside the battery compartment.

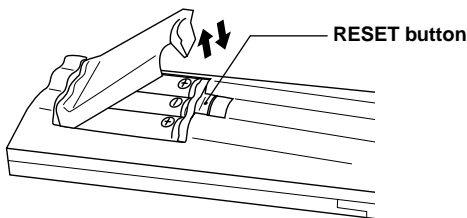

### Notes on batteries

- Change the batteries periodically.
- Do not use old batteries together with new ones.
- Do not use different types of batteries (such as alkaline and manganese batteries) together. Read the packaging carefully as these different types of batteries may have the same shape and color.

### Changing batteries

As the batteries lose power, the operating range of the remote control decreases and the TRANSMIT indicator does not flash or its light becomes dim. When you notice any of these conditions, change all of the batteries.

After you have inserted new batteries, be sure to push RESET in the battery compartment by using a ballpoint pen or similar object before using the remote control. (This does not clear the contents of the memory.)

If the remote control is without batteries for more than 3 minutes, or if exhausted batteries remain in the remote control, the contents of the memory may be cleared. When the memory is cleared, insert new batteries, set up the manufacturer code and program any acquired functions that may have been cleared.

### Note

- If the batteries have leaked, dispose of them immediately. Avoid touching the leaked material or letting it come into contact with clothing, etc. Clean the battery compartment thoroughly before installing new batteries.

# CONTROLS AND FUNCTIONS

## Front Panel

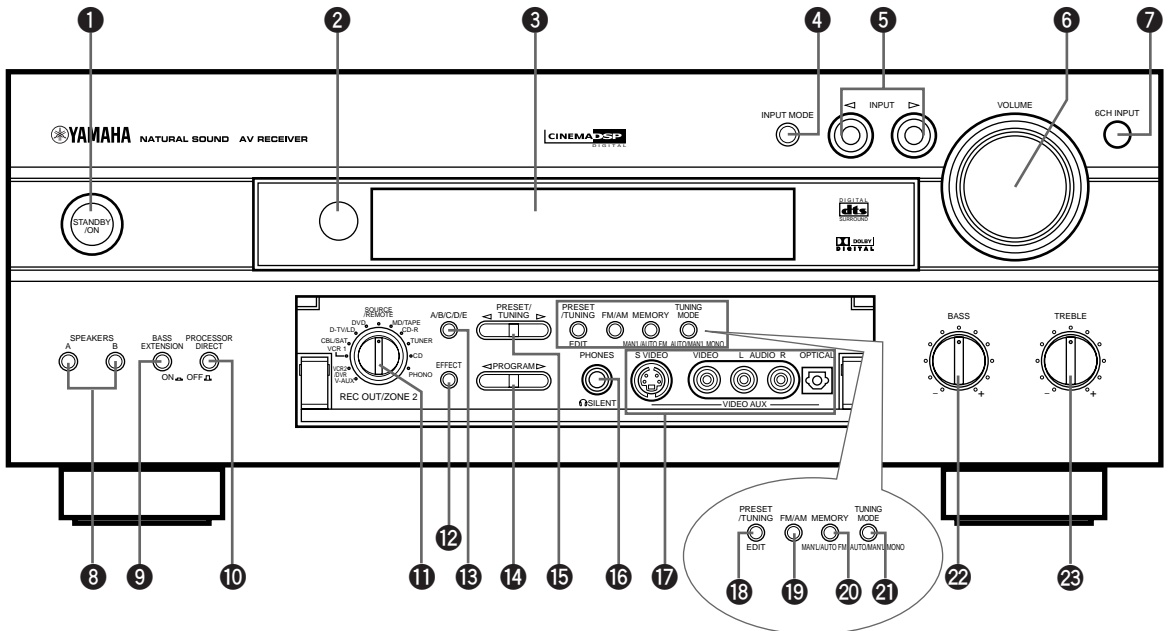

### 1 STANDBY/ON

Turns on and sets this unit in the standby mode. When you turn on this unit, you will hear a click and there will be a 4 to 5-second delay before this unit can reproduce sound.

#### Standby mode

In this mode, this unit consumes a small amount of power to receive infrared-signals from the remote control.

### 2 Remote control sensor

Receives signals from the remote control.

### 3 Front panel display

Shows information about the operational status of this unit (see page 9).

### 4 INPUT MODE

Selects the mode of input for sources that send two or more types of signals to this unit (see page 26). You cannot control the input mode when you select 6CH INPUT as the input source.

### 5 INPUT </>

Selects the input source (DVD, D-TV/LD, CBL/SAT, VCR 1, VCR 2/DVR, V-AUX, PHONO, CD, TUNER, CD-R, MD/TAPE) you want to listen to or watch.

### 6 VOLUME

Controls the output level of all audio channels. This does not affect the REC OUT level.

### 7 6CH INPUT

Selects the source connected to the 6CH INPUT jacks. The source selected by pressing 6CH INPUT takes priority over the source selected with INPUT </> (or the input selector buttons).

### 8 SPEAKERS A/B

Turn on or off the set of main speakers connected to the A and/or B terminals on the rear panel.

### 9 BASS EXTENSION ON/OFF

When pushed in (ON), this feature boosts the bass frequency of the left and right main channels by +6 dB (60 Hz) while maintaining overall tonal balance. This boost is useful if you do not use a subwoofer. However, this boost may not be noticeable if "1B MAIN SP" on the SET MENU is set to SMALL and "1E LFE/BASS OUT" is set to SWFR.

### 10 PROCESSOR DIRECT ON/OFF

When pushed in (ON), BASS, TREBLE, and BASS EXTENSION are bypassed, eliminating any alteration of the original signal.



**11 REC OUT/ZONE 2**

Selects the source you want to direct to the audio/video recorder and ZONE 2 outputs independent of the source you are listening to in the main room. When set to the SOURCE/REMOTE position, the input source is directed to all outputs.

**12 EFFECT**

Switches the effect speakers (center, rear and rear center (see page 17)) on and off. If you turn off the output of these speakers by using EFFECT, all Dolby Digital and DTS audio signals except for the LFE channel are directed to the left and right main channels.

When Dolby Digital or DTS signals are mixed, the left and right main channel signal levels may not match.

**13 A/B/C/D/E**

Selects one of the 5 preset station groups (A to E).

**14 PROGRAM** ◀/▶

Selects the DSP program (see page 28).

**15 PRESET/TUNING** ◀/▶

Selects preset station number 1 to 8 when the colon (:) appears next to the band indication on the front panel display, and selects the tuning frequency when the colon (:): does not appear.

**16 PHONES jack**

Outputs audio signals for private listening with headphones. When you connect headphones, no signals are output to the PRE OUT jacks or to the speakers.

**17 VIDEO AUX jacks**

Inputs audio and video signals from a portable external source such as a game console. To reproduce source signals from these jacks, select V-AUX as the input source. To direct this source to the VCR 1 output jacks, select V-AUX by using REC OUT/ZONE 2.

**18 PRESET/TUNING (EDIT)**

Switches the function of PRESET/TUNING ◀/▶ (the colon (:)) turns on or off) between selecting a preset station number and tuning.

This button is also used to exchange the assignment of two preset stations with each other.

**19 FM/AM**

Switches the reception band between FM and AM.

**20 MEMORY (MAN'L/AUTO FM)**

Stores a station in the memory. Hold down this button for more than 3 seconds to start automatic preset tuning.

**21 TUNING MODE (AUTO/MAN'L MONO)**

Switches the tuning mode between automatic and manual.

To select the automatic tuning mode, press this button so that the "AUTO" indicator lights up on the front panel display. To select the manual tuning mode, press this button so that the "AUTO" indicator does not light up.

**22 BASS**

Adjusts the low-frequency response for the left and right main channels.

Turn the control to the right to increase or to the left to decrease the low-frequency response.

**23 TREBLE**

Adjusts the high-frequency response for the left and right main channels.

Turn the control to the right to increase or to the left to decrease the high-frequency response.

**Note**

- If you increase or decrease the high-frequency or the low-frequency sound to an extreme level, the tonal quality from the center, rear and rear center speakers may not match that of the left and right main speakers.

**Opening and closing the front panel door**

When you are not operating the controls behind the front panel door, close the door.

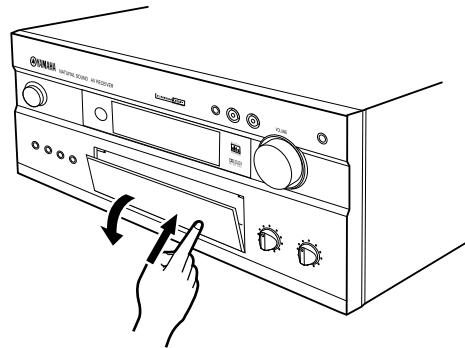

To open, press gently on the lower part of the panel.

# Remote Control

This section describes the basic operation of this unit with the remote control. See "REMOTE CONTROL FEATURES" on pages 47 to 60 for full details.

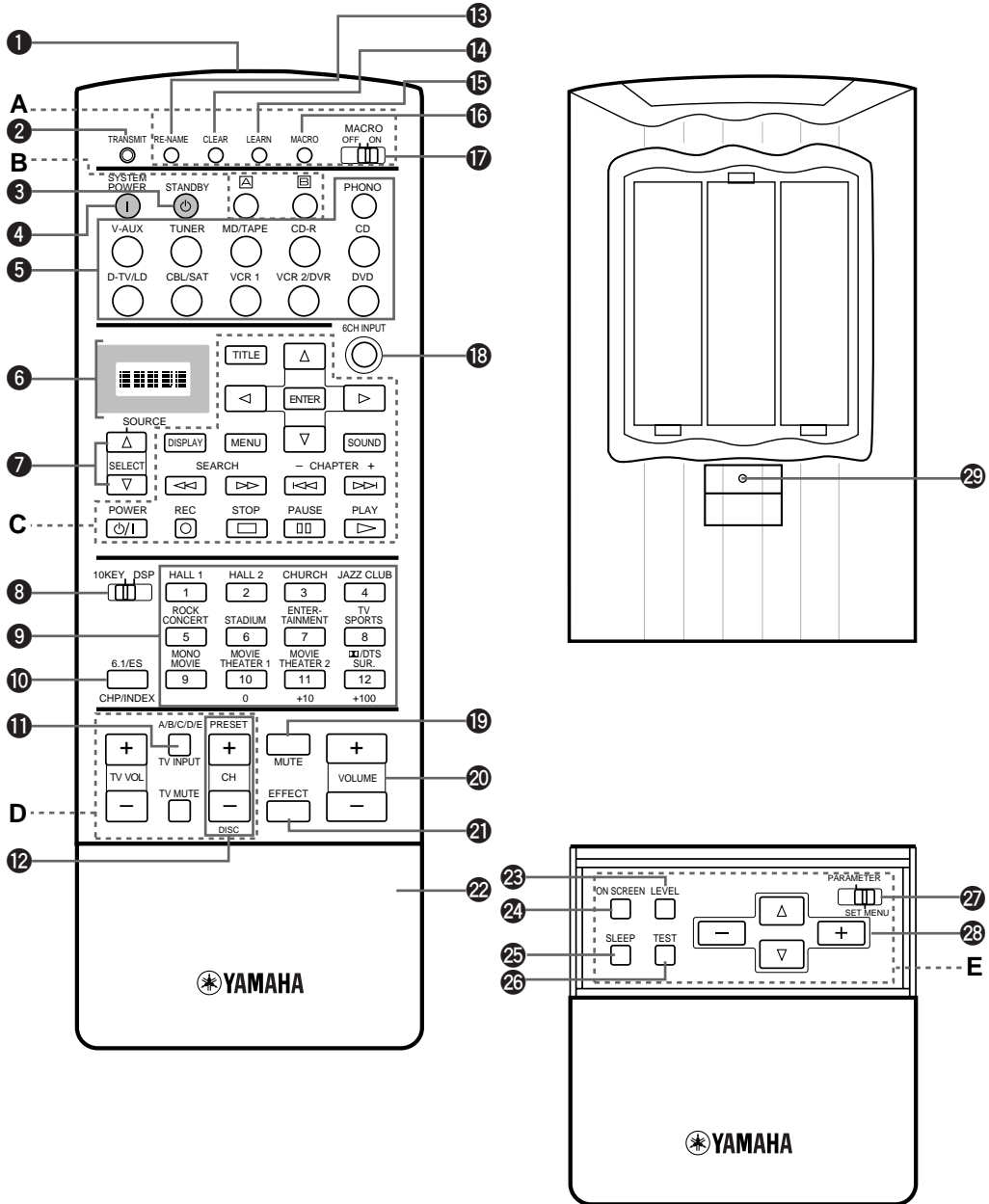

- A Programming section**  
Provides a selection of programming types you can utilize to conveniently operate your other components.
- B A and B buttons**  
See page 47.
- C Operation section**  
Provides functions such as play, stop, skip, etc. for operating your other components.
- D Others**  
Functions vary depending on your components that are set up with the manufacturer code.
- E Setup section**  
Sets speaker output levels, SET MENU, DSP parameters, etc.

**1 Infrared window**

Outputs infrared control signals. Aim this window at the component you want to operate.

**2 TRANSMIT indicator**

Flashes while the remote control is sending signals.

**3 STANDBY**

Sets this unit in the standby mode.

**4 SYSTEM POWER**

Turns on the power of this unit.

**5 Input selector buttons**

Select the input source.

**6 Display window**

Shows the selected source component that you are controlling.

**7 SOURCE SELECT  $\Delta/\nabla$** 

Selects the source component without switching the input.

**8 10KEY/DSP**

Selects the numeric button (10KEY) mode or DSP mode.

**9 DSP program group/Numeric buttons**

Select DSP programs or numbers according to the position of 10KEY/DSP. (Press a button repeatedly to select a DSP program within that group.)

**10 6.1/ES**

Turns on or off the Dolby Digital Matrix 6.1 or DTS ES decoder with 10KEY/DSP set to the DSP position.

**11 A/B/C/D/E**

Selects one of the 5 preset station groups.

**12 PRESET +/-**

Selects a preset station number (1 to 8).

**13 RE-NAME**

Used for changing the input source name in the display window (see page 59).

**14 CLEAR**

Used for clearing functions acquired when using the learn and rename features, programmed macros, and set manufacturer codes (see pages 59 and 60).

**15 LEARN**

Used for setting up the manufacturer code or for programming the functions of other remote controls (see pages 54 to 56).

**16 MACRO**

Used to program a series of operations for control by a single button (see page 58).

**17 MACRO ON/OFF**

Turns the macro function on and off.

**18 6CH INPUT**

Selects the source connected to the 6CH INPUT jacks.

**19 MUTE**

Mutes the sound. Press again to restore the audio output to the previous volume level.

**20 VOLUME +/-**

Increases or decreases the volume level.

**21 EFFECT**

Switches the effect speakers (center, rear and rear center (see page 17)) on and off. If the output of these speakers is turned off, all Dolby Digital and DTS audio signals except for the LFE channel are directed to the left and right main channels.

**22 Cover**

Slides down to show the setup buttons.

**23 LEVEL**

Selects the effect speaker channels (center, rear, rear center (see page 17) and subwoofer) so you can adjust their output level independently.

**24 ON SCREEN**

Selects the on-screen display (OSD) mode for your video monitor.

**25 SLEEP**

Sets the sleep timer.

**26 TEST**

Outputs the test tone.

**27 PARAMETER/SET MENU**

Selects the PARAMETER mode or SET MENU mode.

**28 Cursor buttons  $\Delta/\nabla/-/+$** 

Select and adjust DSP program parameters and SET MENU items according to the position of PARAMETER/SET MENU.

**29 RESET**

Press this button after you have changed the batteries or when the remote control stops working properly. (Pressing RESET does not clear the acquired functions.)

## Using the Remote Control

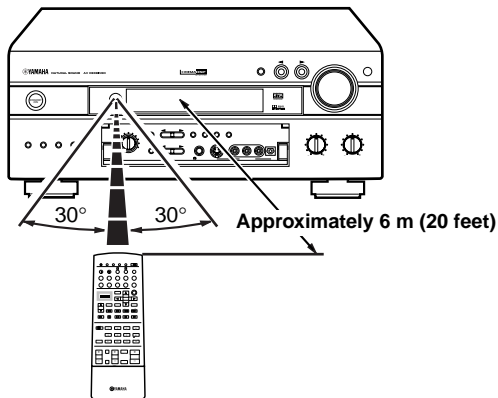

The remote control transmits a directional infrared beam. Be sure to aim the remote control directly at the remote control sensor on the main unit during operation.

### ■ Handling the remote control

- Do not spill water or other liquids on the remote control.
- Do not drop the remote control.
- Do not leave or store the remote control in the following types of conditions:
  - high humidity or temperature such as near a heater, stove or bath;
  - dusty places; or
  - in places subject to extremely low temperatures.

## Front Panel Display

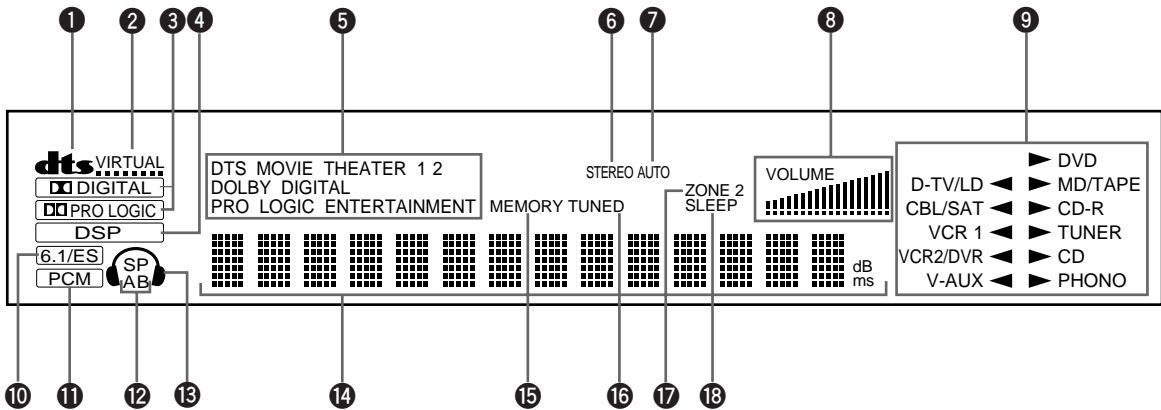

### 1 dts indicator

Lights up when the built-in DTS decoder is on.

### 2 VIRTUAL indicator

Lights up when using Virtual CINEMA DSP (see page 29).

### 3 DIGITAL and PRO LOGIC indicators

Light up according to the type of Dolby signals this unit is reproducing. "DIGITAL" lights up when the built-in Dolby Digital decoder is on. "PRO LOGIC" lights up when the built-in Dolby Pro Logic decoder is on.

### 4 DSP indicator

Lights up when you select a DSP program.

### 5 DSP program indicators

The name of the selected DSP program lights up when the ENTERTAINMENT, MOVIE THEATER 1, MOVIE THEATER 2 or DTS SURROUND DSP program is selected.

### 6 STEREO indicator

Lights up when the unit is receiving a strong signal for an FM stereo broadcast while the "AUTO" indicator is lit.

### 7 AUTO indicator

Shows that this unit is in the automatic tuning mode.

### 8 VOLUME level indicator

Indicates the volume level.

### 9 Input source indicator

Shows the current input source with the arrow-shaped cursor.

### 10 6.1/ES indicator

Lights up when the built-in Dolby Digital Matrix 6.1 or DTS ES decoder is on.

### 11 PCM indicator

Lights up when this unit is reproducing PCM (pulse code modulation) digital audio signals.

### 12 SP A/B indicator

Lights up according to which set of main speakers is selected. Both indicators light up when both sets of speakers are selected.

### 13 Headphones indicator

Lights up when headphones are connected.

### 14 Multi-information display

Shows the current DSP program name and other information when adjusting or changing settings.

### 15 MEMORY indicator

Flashes to show a station can be stored.

### 16 TUNED indicator

Lights up when this unit tunes in to a station.

### 17 ZONE 2 indicator

Lights up when you select the input source while the remote control is in the Zone 2 mode (see pages 61 and 62).

### 18 SLEEP indicator

Lights up while the sleep timer is on.

# Rear Panel

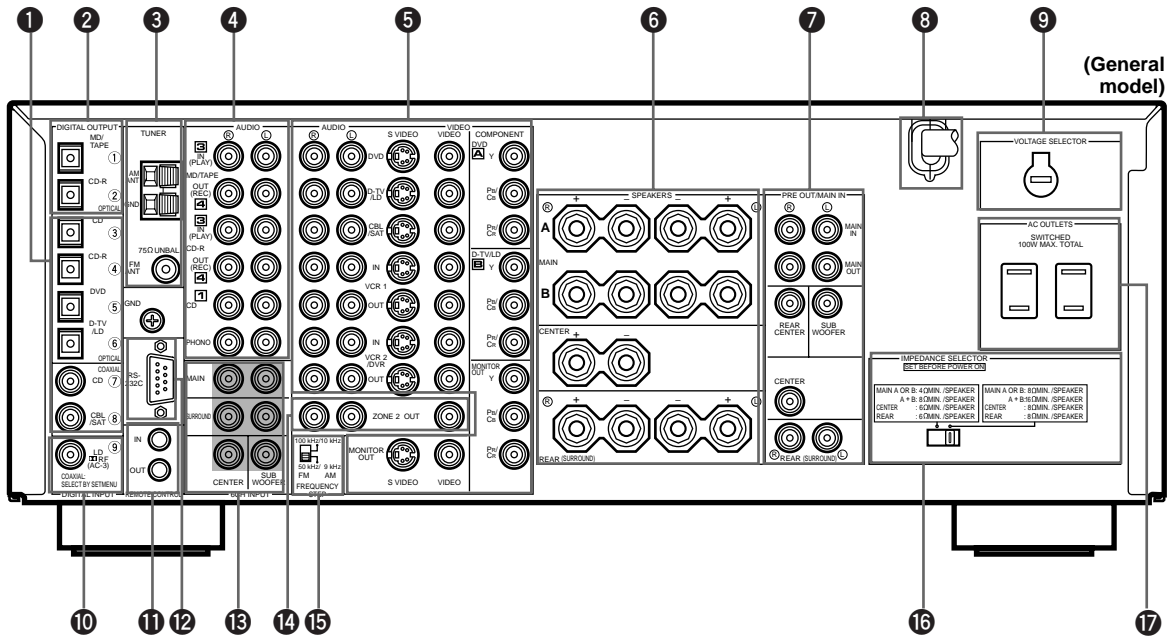

(General model)

- 1 DIGITAL INPUT jacks**
- 2 DIGITAL OUTPUT jacks**
- 3 Antenna input terminals**  
See page 30 for connection information.
- 4 Audio component jacks**  
See pages 12 and 13 for connection information.
- 5 Video component jacks**  
See pages 14 and 15 for connection information.
- 6 Speaker terminals**  
See pages 16 and 17 for connection information.
- 7 PRE OUT/MAIN IN jacks**  
See page 18 for connection information.
- 8 AC power cord**  
Connect to a power outlet.
- 9 VOLTAGE SELECTOR (China and general models only)**  
See page 19.
- 10 RF (AC-3) input jack (China and general models only)**  
See page 14.
- 11 REMOTE CONTROL IN/OUT jacks**  
See page 61 for details.
- 12 RS-232C connector**  
This is a control expansion connector for commercial use. Consult your dealer for details.
- 13 6CH INPUT jacks**  
See pages 13 and 18 for connection information.
- 14 ZONE 2 OUT jacks**  
See page 61 for details.
- 15 FREQUENCY STEP switch (China and general models only)**  
See page 30.
- 16 IMPEDANCE SELECTOR switch**  
Use this switch to match the amplifier output to your speaker impedance. Set this unit in the standby mode before you change the setting of this switch (see page 19).
- 17 AC OUTLET(S)**  
Use these outlets to supply power to your other A/V components (see page 19).

# SPEAKER SETUP

## Speakers to Be Used

This unit has been designed to provide the best sound-field quality with a 5-speaker system, using left and right main speakers, left and right rear speakers and a center speaker. The 6-speaker system, which adds a rear center speaker to the 5 speaker configuration, is the latest advancement in surround sound technology. (See page 17 for using the rear center speaker.) If you use different brands of speakers (with different tonal qualities) in your system, the tone of a moving human voice and other types of sound may not shift smoothly. We recommend that you use speakers from the same manufacturer or speakers with the same tonal quality.

The main speakers are used for the main source sound plus the effect sounds. They will probably be the speakers from your present stereo system. The rear speakers are used for the effect and surround sounds, and the center speaker is for the center sounds (dialog, vocals, etc.). If for some reason it is not practical to use a center speaker, you can do without it. Best results, however, are obtained with the full system.

The main speakers should be high-performance models and have enough power-handling capacity to accept the maximum output of your audio system. The other speakers do not have to be equal to the main speakers. For precise sound localization, however, it is ideal to use high-performance models that can reproduce sounds over the full range for the center speaker and the rear speakers.

### ■ Use of a subwoofer expands your sound field

It is also possible to further expand your system with the addition of a subwoofer. The use of a subwoofer is effective not only for reinforcing bass frequencies from any or all channels, but also for reproducing the LFE (low-frequency effect) channel with high fidelity when the Dolby Digital signal or the DTS signal is played back. The YAMAHA Active Servo Processing Subwoofer System is ideal for natural and lively bass reproduction.

## Speaker Placement

Refer to the following diagram when you place the speakers.

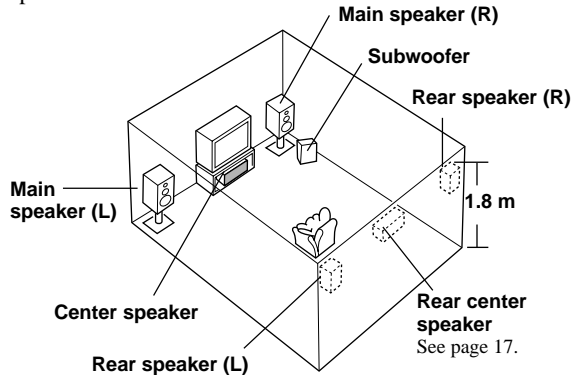

### ■ Main speakers

Place the left and right main speakers an equal distance from the ideal listening position. The distance of each speaker from each side of the video monitor should be the same.

### ■ Rear speakers

Place these speakers behind your listening position, facing slightly inwards, nearly 1.8 m (approx. 6 feet) above the floor.

### ■ Center speaker

Align the front face of the center speaker with the front face of your video monitor. Place the speaker as close to the monitor as possible, such as directly over or under the monitor and centrally between the main speakers.

#### Note

- If the center speaker is not used, the center channel sound will be heard from the left and right main speakers. In this case, "1A CENTER SP" on the SET MENU is set to NONE (see page 38 for details).

### ■ Subwoofer

The position of the subwoofer is not so critical, because low bass sounds are not highly directional. But it is better to place the subwoofer near the main speakers. Turn it slightly toward the center of the room to reduce the wall reflections.

#### CAUTION

Some types of speakers interfere with a video monitor. If this problem occurs, move the speakers away from the monitor. If you cannot avoid installing the center speaker or subwoofer near the video monitor, use a magnetically shielded speaker.

# CONNECTIONS

## Before Connecting Components

### CAUTION

Never connect this unit and other components to mains power until all connections between components have been completed.

- Be sure all connections are made correctly, that is to say L (left) to L, R (right) to R, “+” to “+” and “-” to “-”. Some components require different connection methods and have different jack names. Refer to the operation instructions for each component to be connected to this unit.
- When you connect other YAMAHA audio components (such as a tape deck, MD recorder and CD player or changer), connect them to the jack with the same number labels as **1**, **3**, **4** etc. YAMAHA applies this labeling system to all its products.
- After you have completed all connections, check them again to make sure they are correct.

## Connecting Audio Components

### ■ Connecting to digital jacks

This unit has digital jacks for direct transmission of digital signals through either coaxial or fiber optic cables. You can use the digital jacks to input PCM, Dolby Digital and DTS bitstreams. When you connect components to both the COAXIAL and OPTICAL jacks, priority is given to the input signals from the COAXIAL jack. All digital input jacks are acceptable for 96-kHz sampling digital signals (see page 25 for details).



- You can designate the input for each digital jack according to your component by using “7 I/O ASSIGNMENT” on the SET MENU (see page 41 for details).

### About the dust protection cap

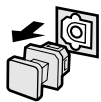

Pull out the cap from the optical jack before you connect the fiber optic cable. Do not discard the cap. When you are not using the optical jack, be sure to put the cap back in place. This cap protects the jack from dust.

### Note

- The OPTICAL jacks on this unit conform to the EIA standard. If you use a fiber optic cable that does not conform to this standard, this unit may not function properly.

### ■ Connecting a turntable

PHONO jacks are for connecting a turntable with an MM or high-output MC cartridge. If you have a turntable with a low-output MC cartridge, use an inline boosting transformer or MC-head amplifier when connecting to these jacks.



- The GND terminal does not electrically ground the turntable. It simply reduces noise in the signal. In some cases, you may hear less noise if you do not connect to the GND terminal.

### ■ Connecting a CD player



- The COAXIAL CD and OPTICAL CD jacks are available for a CD player which has coaxial or optical digital output jacks.
- When you connect a CD player to both the COAXIAL CD and OPTICAL CD jacks, priority is given to the input signals from the COAXIAL CD jack.

### ■ Connecting an MD recorder, tape deck or CD recorder



- Only digital signals input from a source such as a CD or DVD are output from the DIGITAL OUTPUT jacks.
- When you connect your recording component to both the analog and digital input and output jacks, the priority is given to the digital signal.
- You can connect an MD recorder to any digital input jack by using “7 I/O ASSIGNMENT” on the SET MENU (see page 41).

### Notes

- When you connect a recording component to this unit, keep its power on while using this unit. If the power is off, this unit may distort the sound from other components.
- When you record from a source component connected to this unit while this unit is set in the standby mode, the recorded sound may be distorted. To avoid this problem, turn on this unit.



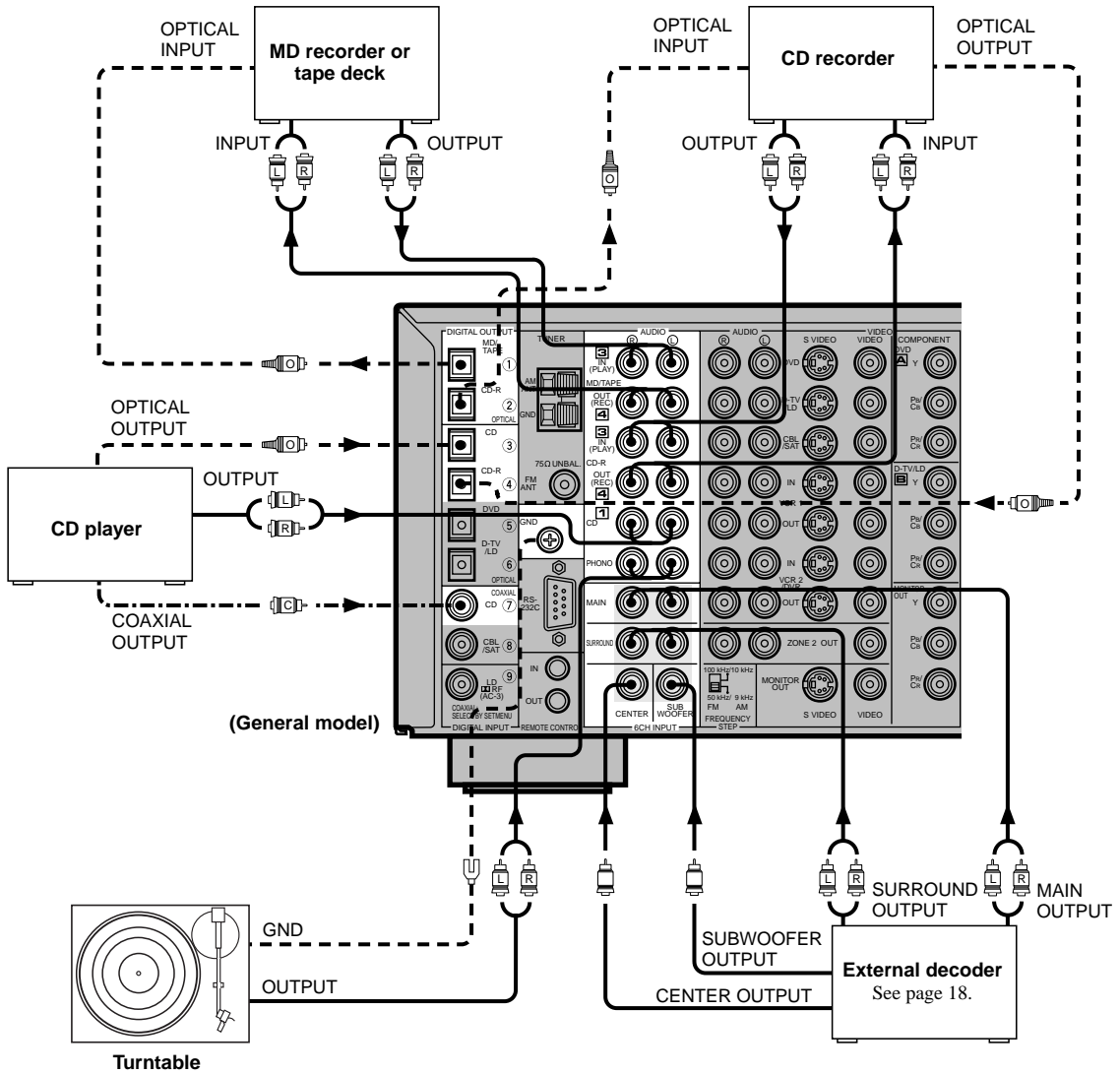

- indicates signal direction
- indicates left analog cables
- indicates right analog cables
- indicates optical cables
- indicates coaxial cables

PREPARATION

English

## Connecting Video Components

### About the video jacks

There are three types of video jacks. Video signals input through the VIDEO jacks are the conventional composite video signals. Video signals input through the S VIDEO jacks are separated into luminance (Y) and color (C) video signals. The S-video signals achieve high-quality color reproduction. Video signals input through the COMPONENT VIDEO jacks are separated into luminance (Y) and color difference (P<sub>B</sub>/C<sub>B</sub>, P<sub>R</sub>/C<sub>R</sub>) video signals. The jacks are also separated into three for each signal. The description of the component video jacks may be different depending on the component (e.g. Y, C<sub>B</sub>, C<sub>R</sub>/Y, P<sub>B</sub>, P<sub>R</sub>/Y, B-Y, R-Y etc.). Component video signals provide the best quality in picture reproduction.

If your video component has an S-video output or component video output, you can connect it to this unit. Connect the S-video signal output jack on your video component to the S VIDEO jack or connect the component signal output jacks on your video component to the COMPONENT VIDEO jacks.

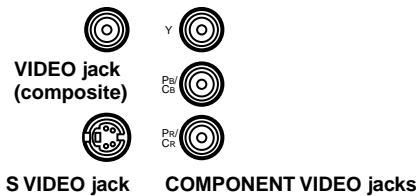

- Each type of video jack works independently. Signals input through the composite video, S-video and component jacks are output through the corresponding composite video, S-video, and component jacks, respectively.
- If you make S-video connections to this unit, it is not necessary to make composite video connections. If both types of connections are made, this unit gives priority to the S-video signal.
- You can designate the input for the COMPONENT VIDEO A and B jacks according to your component by using "7 I/O ASSIGNMENT" on the SET MENU (see page 41 for details).

#### Notes

- Use a commercially available S-video cable when connecting to the S VIDEO jack, and commercially available video cables when connecting to the COMPONENT VIDEO jacks.
- When you are using the COMPONENT VIDEO jacks, check the details in the owner's manual that came with the component being connected.

### VIDEO AUX jacks (on the front panel)

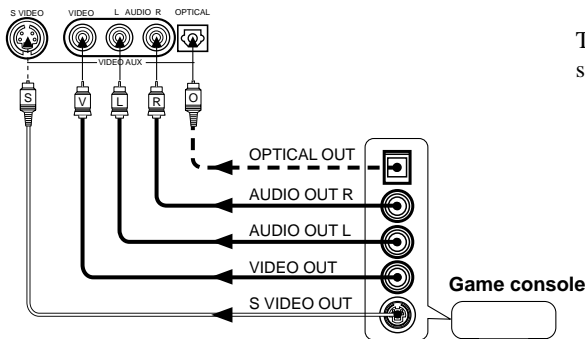

These jacks are used to connect any video input source such as a game console to this unit.

### About the RF (AC-3) signal input jack (China and general models only)

If your LD player has a Dolby Digital RF (AC-3) signal output jack, connect it to the  RF (AC-3) input jack on this unit. If the Dolby Digital RF (AC-3) and analog signals are input at the same time, priority is given to the RF signals. When you want to reproduce the Dolby Digital RF (AC-3) signals, set the input mode to D.D. RF by using INPUT MODE (see page 26).



#### Notes

- The Dolby Digital RF (AC-3) signals cannot be output by using the REC OUT selector. When you record sound or images from an LD player, be sure to connect the player to either the DIGITAL OPTICAL or analog audio jacks.
- Even if you connect an LD player with the Dolby Digital RF (AC-3) output jack to this unit, you cannot reproduce Dolby Digital sound from all LD discs. You must playback an LD encoded with Dolby Digital signals in order to take advantage of the Dolby Digital sound.

**Note**

(U.S.A., Canada, Australia and Singapore models only)

- If your LD player has a Dolby Digital RF signal output jack, connect it to this unit through an RF demodulator (separately purchased).

PREPARATION

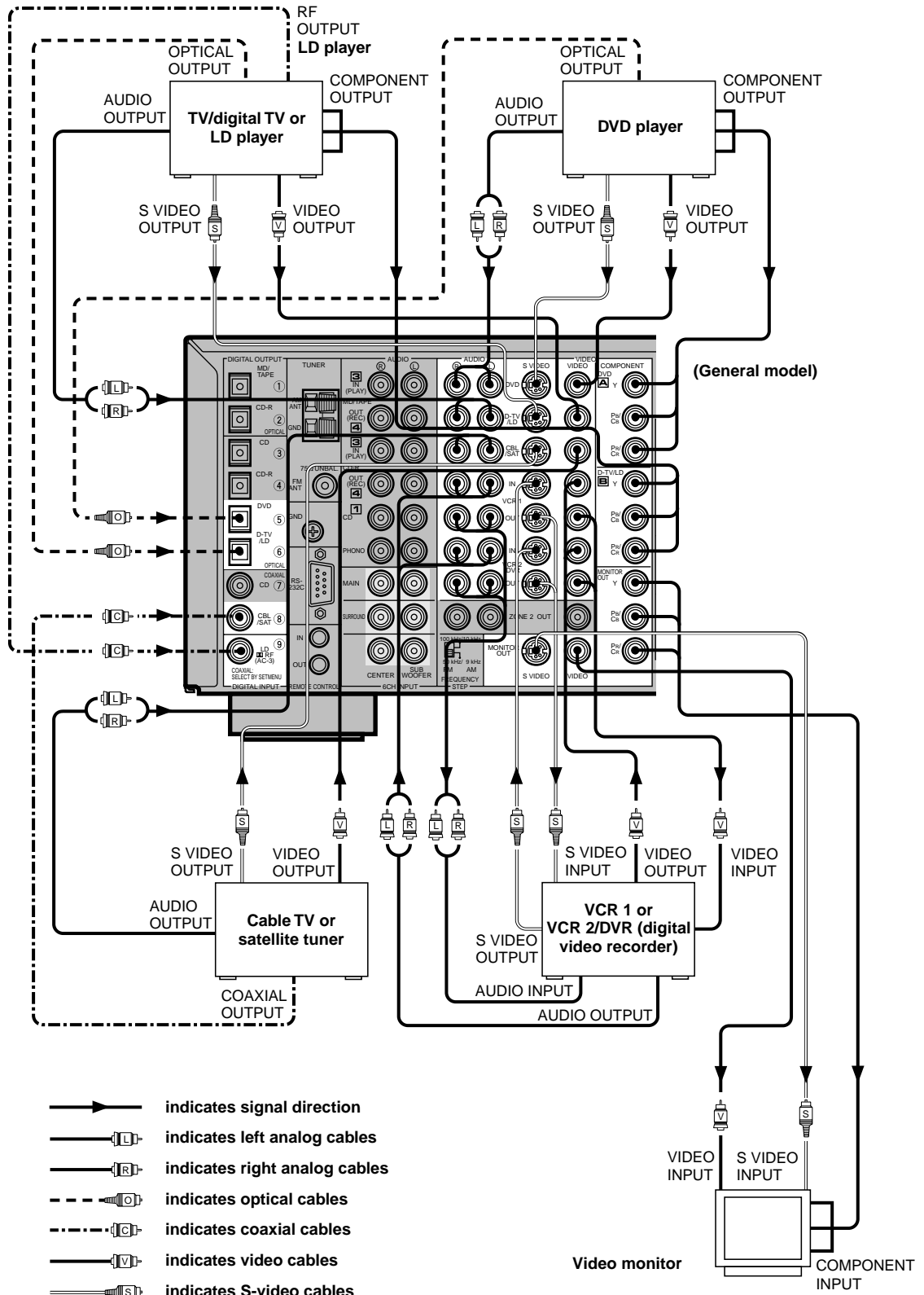

English

## Connecting the Speakers

Be sure to connect the left channel (L), right channel (R), “+” (red) and “-” (black) properly. If the connections are faulty, no sound will be heard from the speakers, and if the polarity of the speaker connections is incorrect, the sound will be unnatural and lack bass.

### CAUTION

- Use speakers with the specified impedance shown on the rear panel of this unit.
- Do not let the bare speaker wires touch each other and do not let them touch any metal part of this unit. This could damage the unit and/or speakers.

If necessary, use the SET MENU to change the speaker mode settings according to the number and size of the speakers in your configuration after you finish connecting your speakers.

### ■ Speaker cables

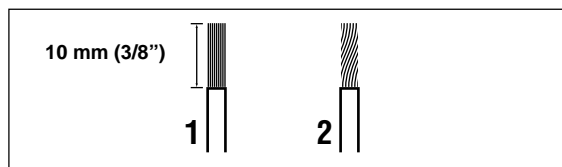

A speaker cord is actually a pair of insulated cables running side by side. One of the cables is colored or shaped differently, perhaps with a stripe, groove or ridge.

- 1 Remove approx. 10 mm (3/8") of insulation from each of the speaker cables.**
- 2 Twist the exposed wires of the cable together to prevent short circuits.**

### ■ Connecting to the SPEAKERS terminals

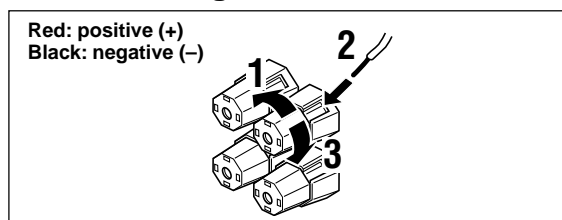

Red: positive (+)  
Black: negative (-)

- 1 Unscrew the knob.**
- 2 Insert one bare wire into the hole in the side of each terminal.**
- 3 Tighten the knob to secure the wire.**

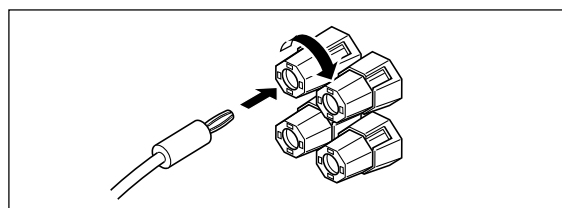

(U.S.A., Canada, Australia, China and general models only)

- Banana plug connections are also possible. First, tighten the knob and then insert the banana plug connector into the end of the corresponding terminal.

### ■ MAIN SPEAKERS terminals

One or two speaker systems can be connected to these terminals. If you use only one speaker system, connect it to either of the MAIN A or B terminals.

### ■ REAR SPEAKERS terminals

A rear speaker system can be connected to these terminals.

### ■ CENTER SPEAKER terminals

A center speaker can be connected to these terminals.

## Using the rear center speaker

You can enjoy the Dolby Digital Surround EX software or DTS ES software by adding the rear center speaker to the 5-speaker configuration.

### Rear center speaker placement

Place the rear center speaker in the center between the left and right rear speakers at the same height from the floor as the rear speakers.

### Connecting the rear center speaker

- 1** Connect the PRE OUT REAR CENTER jack on this unit to the input jack on the separately prepared power amplifier.
- 2** Connect the rear center speaker to the speaker terminals on this power amplifier.

#### Note

- Be sure to correctly connect the + terminal of the speaker to the + terminal on the power amplifier, and the – terminal of the speaker to the – terminal on the power amplifier.

### Setting up this unit for using the rear center speaker

When you use a rear center speaker, “1D REAR CT SP” on the SET MENU must be set to LRG or SML (see page 39).

#### Note

- No sound is output from the rear center speaker when “1C REAR L/R SP” on the SET MENU is set to NONE (see page 38 for details).

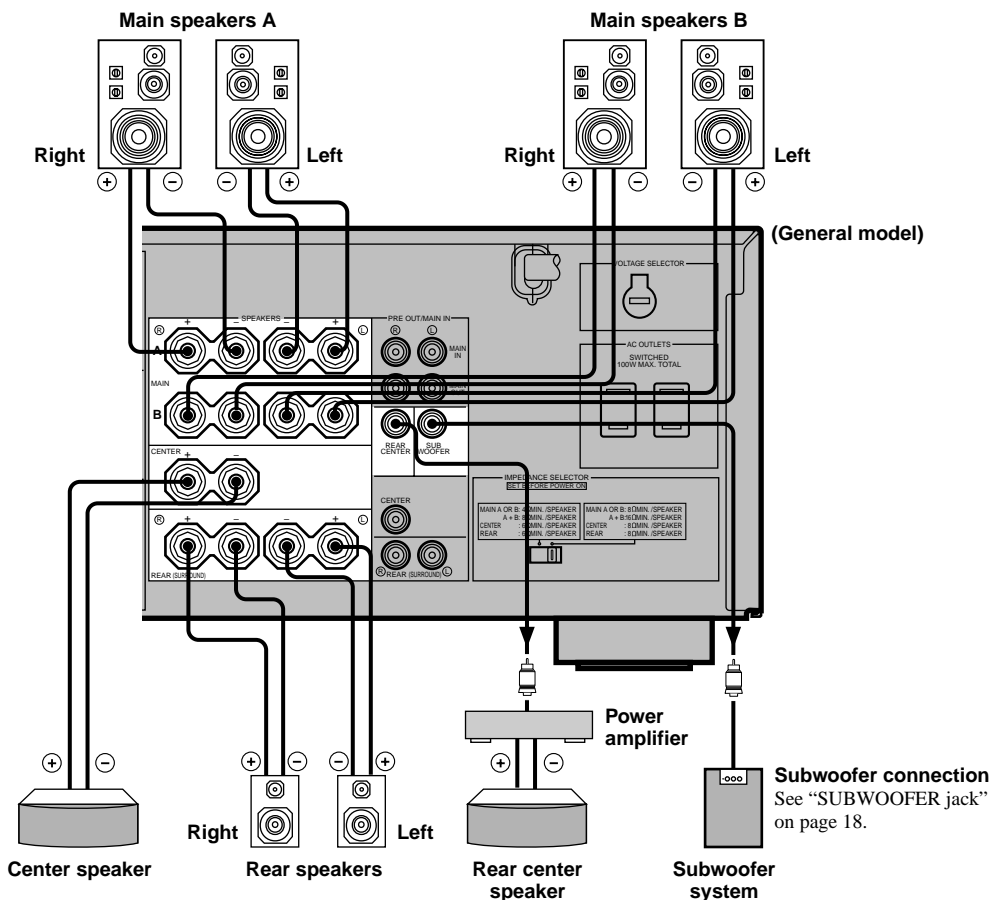

## Connecting to an External Amplifier

If you want to increase the power output to the speakers, or want to use another amplifier, connect an external amplifier to the PRE OUT jacks as follows.

### Note

- When RCA pin plugs are connected to the PRE OUT jacks for output to an external amplifier, do not use the corresponding SPEAKERS terminals.

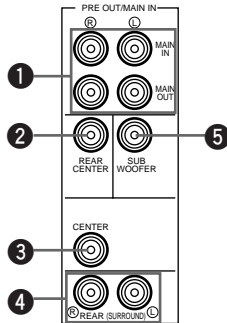

### 1 MAIN jacks

- MAIN IN jacks  
Line input to this unit's main channel amplifiers.
- MAIN OUT jack  
Main channel line output jacks.

### Note

- The signals output through these jacks are affected by the BASS, TREBLE and BASS EXTENSION settings.

### 2 REAR CENTER jack

Rear center channel line output jack.

### 3 CENTER jack

Center channel line output jack.

### 4 REAR (SURROUND) jacks

Rear channel line output jacks.

### 5 SUBWOOFER jack

When using a subwoofer with built-in amplifier, including the YAMAHA Active Servo Processing Subwoofer System, connect the input jack of the subwoofer system to this jack.

Low bass signals distributed from the main, center and/or rear channels are directed to this jack. (The cut-off frequency of this jack is 90 Hz.) The LFE (low-frequency effect) signals generated when Dolby Digital or DTS is decoded are also directed if they are assigned to this jack.

### Notes

- Adjust the volume level of the subwoofer with the control on the subwoofer. The subwoofer volume cannot be adjusted from this unit.
- Depending on the settings of "1 SPEAKER SET", "10A LFE LEVEL" and "11 DTS LFE LEVEL" on the SET MENU, some signals may not be output from the SUBWOOFER jack.

## Connecting an External Decoder

This unit is equipped with 6 additional input jacks (left and right MAIN, CENTER, left and right SURROUND and SUBWOOFER) for discrete multi-channel input from an external decoder, sound processor or pre-amplifier.

Connect the output jacks on your external decoder to the 6CH INPUT jacks. Be sure to match the left and right outputs to the left and right input jacks for the main and surround channels.

### Notes

- When you select 6CH INPUT as the input source, this unit automatically turns off the digital sound field processor, and you cannot listen to DSP programs.
- When you select 6CH INPUT as the input source, changing items 1A to 1F on the SET MENU is not affected.

## IMPEDANCE SELECTOR Switch

### WARNING

Do not change the IMPEDANCE SELECTOR switch setting while the power of this unit is on, otherwise the unit may be damaged.

If this unit fails to turn on when STANDBY/ON (or SYSTEM POWER) is pressed, the IMPEDANCE SELECTOR switch may not be fully slid to either position. If so, slide the switch to either position fully when this unit is in the standby mode.

Select the left or right position according to the impedance of the speakers in your system. Be sure to move this switch only when this unit is in the standby mode.

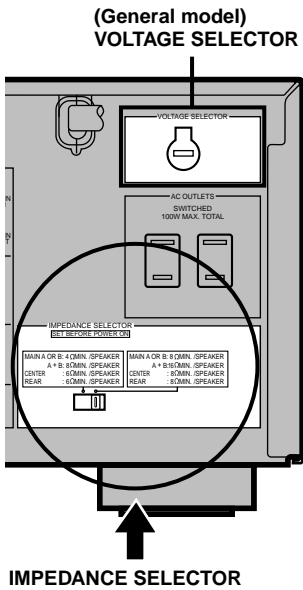

Switch position	Speaker	Impedance level
Left	Main	If you use one set of main speakers, the impedance of each speaker must be 4 Ω or higher. If you use two sets of main speakers, the impedance of each speaker must be 8 Ω or higher.
	Center	The impedance must be 6 Ω or higher.
	Rear	The impedance of each speaker must be 6 Ω or higher.
Right	Main	If you use one set of main speakers, the impedance of each speaker must be 8 Ω or higher. If you use two sets of main speakers, the impedance of each speaker must be 16 Ω or higher. [Canada model only] The impedance of each speaker must be 8 Ω or higher.
	Center	The impedance must be 8 Ω or higher.
	Rear	The impedance of each speaker must be 8 Ω or higher.

### VOLTAGE SELECTOR (China and general models only)

The VOLTAGE SELECTOR on the rear panel of this unit must be set for your local main voltage BEFORE plugging into the AC main supply. Voltages are 110/120/220/240 V AC, 50/60 Hz.

## Connecting the Power Supply Cords

After completing all connections, connect the AC power cord to an AC power outlet. Disconnect the AC power cord if you will not use this unit for a long period of time.

### AC OUTLET(S) (SWITCHED)

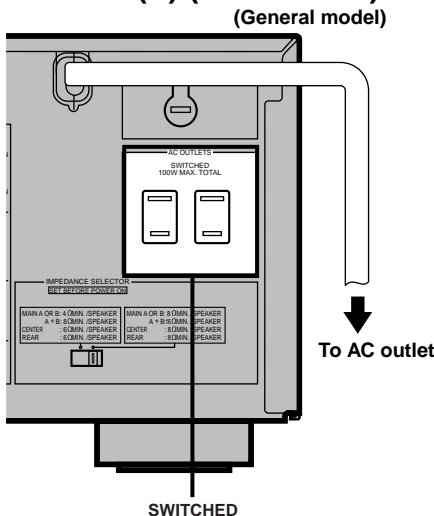

U.S.A., Canada, Singapore, China and general models ..... 2 OUTLETS  
 Australia model ..... 1 OUTLET  
 Use these outlets to connect the power cords from your components to this unit. The power to the AC OUTLET(S) is controlled by this unit's STANDBY/ON (or SYSTEM POWER and STANDBY). These outlets will supply power to any connected component whenever this unit is turned on. The maximum power (total power consumption of components) that can be connected to the AC OUTLET(S) is 100 W.

# ON-SCREEN DISPLAY (OSD)

You can display the operation information for this unit on a video monitor. If you display the SET MENU and DSP program parameter settings on a monitor, it is much easier to see the available options and parameters than it is by reading this information on the front panel display.



- If a video source is being reproduced, the OSD is superimposed over the image.
- The OSD signal is not output to the REC OUT jack, and will not be recorded with any video signal.
- You can set the OSD to turn on (blue background) or off when a video source is not being reproduced (or the source component is turned off) by using “14 DISPLAY SET” on the SET MENU (see page 44).

## OSD Modes

You can change the amount of information the OSD shows.

### Full display

This mode always shows the DSP program parameter settings on the video monitor (see page 69).

### Short display

This mode briefly shows the same contents as the front panel display at the bottom of the screen and then disappears.

### Display off

This mode briefly shows the “DISPLAY OFF” message at the bottom of the screen and then disappears.

Afterwards, no changes to operations appear on the monitor except those of the ON SCREEN button.

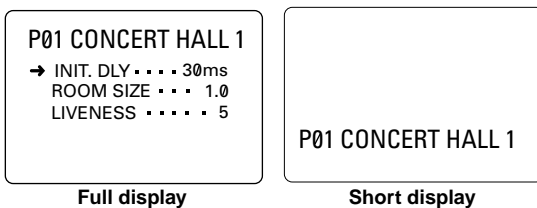

- When you choose the full display mode, INPUT <|/>, VOLUME and some other types of operation information are displayed at the bottom of the screen in the same format as that for the front panel display.
- The SET MENU and test tone display appear regardless of the OSD mode.

## Selecting the OSD Mode

**1** When you turn on the power, the video monitor and front panel display show the level of the main volume for a few seconds and then switch to show the current DSP program.

**2** Press ON SCREEN on the remote control repeatedly to change the display mode. The OSD mode changes in the following order: full display, short display, and display off.

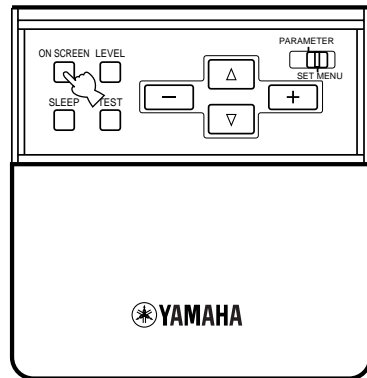

### Notes

- If you choose a video input source that has a component connected to both the S VIDEO IN and composite VIDEO IN jacks, and both the S VIDEO OUT and composite VIDEO OUT jacks are connected to a video monitor, the video signal is output to both the S VIDEO OUT and VIDEO OUT jacks. However, the OSD is carried only on the S-video signal. If no video signal is input, the OSD is carried on both the S-video and composite video signals.
- If your video monitor is connected only to the COMPONENT VIDEO jacks of this unit, the OSD is not shown. Make sure to connect your video monitor to the COMPONENT VIDEO jacks and either VIDEO or S VIDEO jacks if you want to see the OSD.
- Playing back video software that has an anti-copy signal or video signals with a lot of noise may produce unstable images.



# SPEAKER MODE SETTINGS

This unit has 6 SPEAKER SET items on the SET MENU that you must set according to the number of speakers in your configuration and their size. The following table summarizes these SPEAKER SET items, and shows the initial settings as well as other possible settings. If the initial settings are not appropriate for your speaker configuration, change the settings on the SET MENU (see page 36).

## Summary of SPEAKER SET Items 1A through 1F

Item	Description	Initial setting
<b>1A CENTER SP</b>	Selects the center channel output mode according to the size of the center speaker. The possible settings are LRG (large), SML (small) and NONE.	LRG
<b>1B MAIN SP</b>	Selects the main channel output mode according to the size of the main speakers. The possible settings are LARGE and SMALL.	LARGE
<b>1C REAR L/R SP</b>	Selects the rear channel output mode according to the size of the rear speakers. The possible settings are LRG (large), SML (small) and NONE.	LRG
<b>1D REAR CT SP</b>	Selects the rear center channel output according to the size of the rear center speaker. The possible settings are LRG (large), SML (small) and NONE.	NONE
<b>1E LFE/BASS OUT</b>	Selects a speaker for the LFE signal output and low bass signal. The possible settings are SWFR (subwoofer), MAIN, and BOTH.	BOTH
<b>1F MAIN LEVEL</b>	Selects the output level for the main channel signal. The possible settings are Normal and -10 dB.	Normal

# ADJUSTING THE SPEAKER OUTPUT LEVELS

This section explains how to adjust the speaker output levels by using the test tone generator. When this adjustment is made, the output level heard at the listening position will be the same from each speaker. This is important for the best performance of the digital sound field processor, the Dolby Pro Logic decoder, Dolby Digital decoder and DTS decoder.

## Note

- Since this unit cannot enter the test mode while headphones are connected to this unit, be sure to unplug the headphones from the PHONES jack when using the test tone.

## Before You Begin

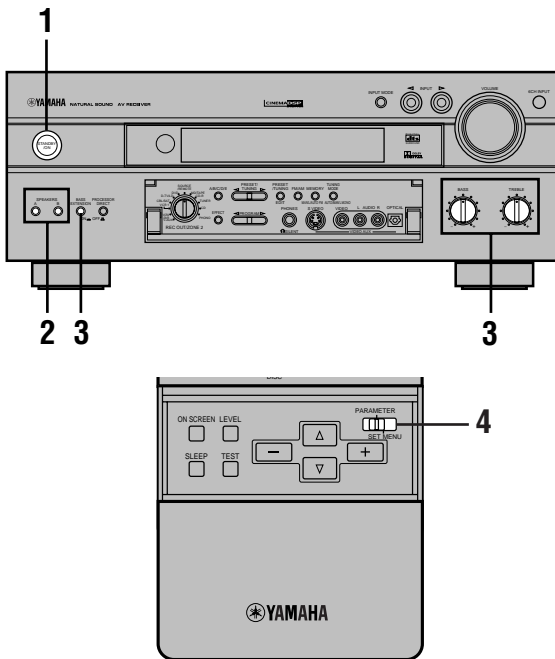

- 1 Press STANDBY/ON to turn on the power. Turn on the video monitor.**



- 2 Press SPEAKERS A or B to select the main speakers to be used.**

If you are using two sets of the main speakers, press both A and B.

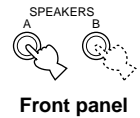

- 3 Set BASS and TREBLE on the front panel to the center position and set BASS EXTENSION to OFF.**

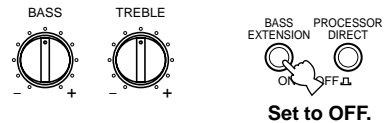

- 4 Sit in the listening position and set PARAMETER/SET MENU on the remote control to PARAMETER.**

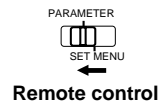

## Using the Test Tone (TEST DOLBY SUR.)

Use the test tone to balance the output levels of the 6 speakers required for a surround sound system. The adjustment of each speaker output level should be made at your listening position with the remote control. After completing the adjustments, use VOLUME +/- at your listening position to check if the adjustments are satisfactory.

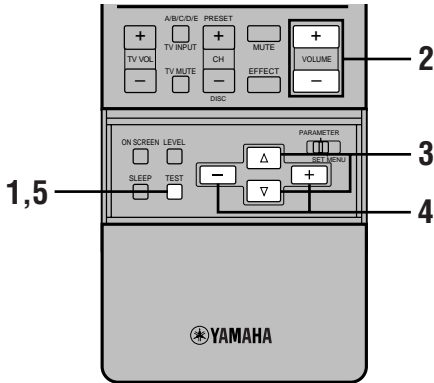

**1** Press TEST to output the test tone.



**2** Adjust the volume so you can hear the test tone.

The test tone is heard from the left main speaker, center speaker, right main speaker, right rear speaker, rear center speaker (see page 17) and left rear speaker in order. The tone is produced for 2.5 seconds each time.

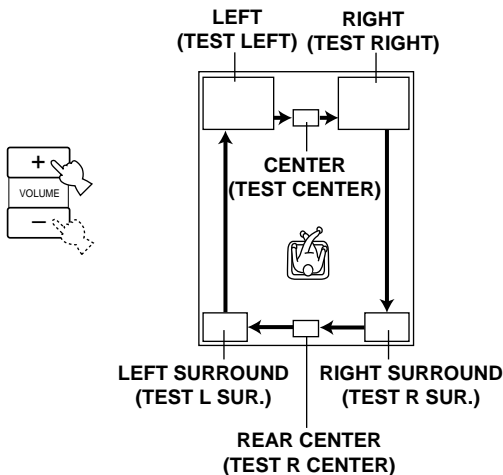

The state of the test tone output is also shown on the monitor by an image of the audio listening room. This is convenient for adjusting each speaker level.

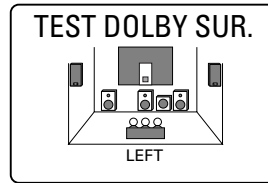

- If "1A CENTER SP" on the SET MENU is set to NONE, the center channel sound is automatically output from the left and right main speakers.

**Note**

- If the test tone cannot be heard, turn down the volume, set the unit in the standby mode and check the speaker connections.

**3** Press  $\Delta$  /  $\nabla$  repeatedly to select the speaker to be adjusted.

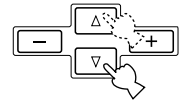

- You can stop the sequence temporarily by holding down  $\Delta$  /  $\nabla$ .

**4** Press +/- repeatedly to adjust the output level of the effect speakers so that the output level coming from each speaker is the same.

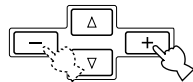

While adjusting, the test tone is heard from the selected speaker.

**5** When the adjustment is complete, press TEST.

The test tone stops and the current DSP program appears on the front panel display and on the video monitor.



- The tonal quality of the center speaker can be adjusted by using "5 CENTER GEQ" on the SET MENU (see page 41).
- You can increase the output levels of the effect speakers (center, left rear, right rear and rear center) to +10 dB. If the output level of these speakers is lower than that of the main speakers even after you have increased the output level of these speakers up to +10 dB, set "1F MAIN LEVEL" on the SET MENU to -10 dB (see page 40). This setting decreases the main speaker output level to about one-third of the normal level. After you have set "1F MAIN LEVEL" on the SET MENU to -10 dB, adjust the levels for the center, rear and rear center speakers again.

# BASIC PLAYBACK

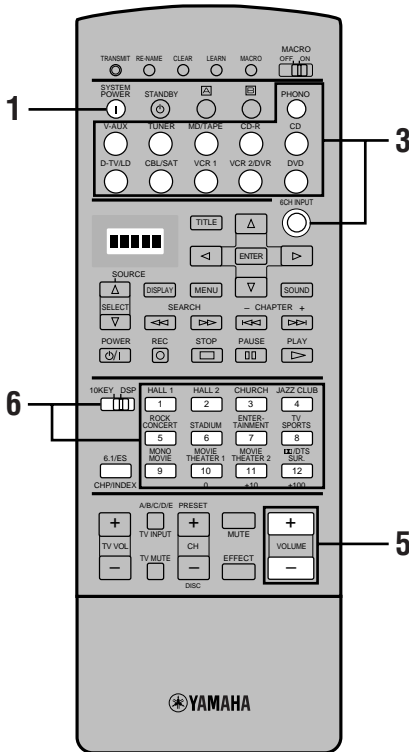
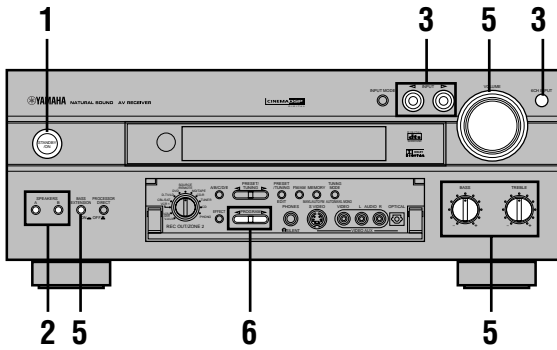

**1** Press **STANDBY/ON** (or **SYSTEM POWER**) to turn on the power. Turn on the video monitor.

The front panel display and the video monitor show the level of the main volume for a few seconds and then switch to show the current DSP program.



Front panel

or



Remote control

**2** Press **SPEAKERS A** or **B** to select the main speakers to be used.

If you are using two sets of main speakers, press both A and B.

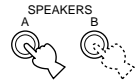

Front panel

**3** Press **INPUT** </> repeatedly (or press one of the input selector buttons) to select the input source.

- The current input source is indicated on the front panel display with an arrow.
- The current input source name and input mode appear on the front panel display and on the video monitor for a few seconds.

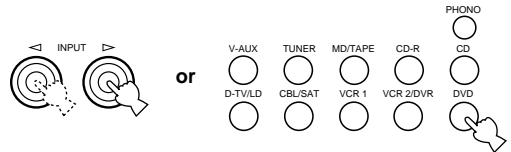

Front panel

Remote control



Selected input source

**Select this:** To reproduce the signal from this component

- |            |   |
|------------|---|
| DVD:       | DVD player  |
| D-TV/LD:   | TV or digital TV/LD player  |
| CBL/SAT:   | Cable TV/satellite tuner  |
| VCR 1:     | Video cassette recorder 1   |
| VCR 2/DVR: | Video cassette recorder 2/digital video recorder                            |
| V-AUX:     | Another A/V component (connected to the VIDEO AUX jacks on the front panel) |
| PHONO:     | Turntable   |
| CD:        | CD player   |
| TUNER:     | AM/FM tuner   |
| CD-R:      | CD recorder   |
| MD/TAPE:   | MD recorder/tape deck   |

**To select a source connected to the 6CH INPUT jacks**

Press 6CH INPUT until “6CH INPUT” appears on the front panel display and on the video monitor.

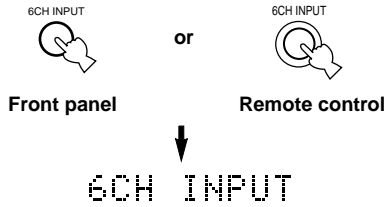

**Notes**

- If “6CH INPUT” is shown on the front panel display and on the video monitor, no other source can be played. To select another input source with INPUT ◀/▶ (or the input selector buttons), press 6CH INPUT to turn off “6CH INPUT” from the front panel display and the video monitor.
- If you want to enjoy an audio source connected to the 6CH INPUT jacks together with a video source, first select the video source and then press 6CH INPUT.

**4 Start playback (or select a broadcast station) on the source component.**

Refer to the operation instructions for the component.

**5 Adjust the volume to the desired output level.**

If desired, use BASS, TREBLE and BASS EXTENSION, etc. These controls are only effective for sound from the main speakers.

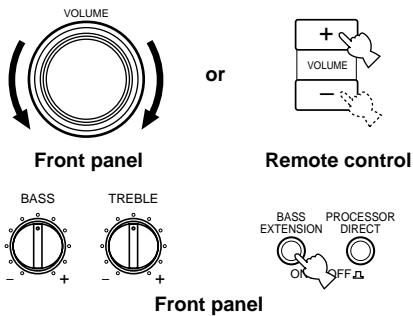

**Note**

- If the component connected to the VCR 1 OUT, VCR 2/DVR OUT, CD-R OUT and MD/TAPE OUT jacks is turned off, the reproduced sound may be distorted or the volume may be lowered. In these cases, turn on the component.

**6 Use the digital sound field processor.**

See page 28.

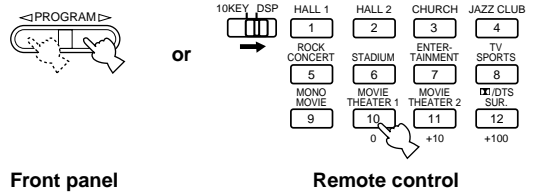

**To mute the sound**

Press MUTE on the remote control.



To restore the audio output to the previous volume level, press MUTE again.



- You can also cancel mute to press any operation buttons such as VOLUME +/-.
- During muting, “MUTE ON” appears on the front panel display and on the video monitor.

**When you have finished using this unit**

Press STANDBY/ON (or STANDBY) to set this unit in the standby mode.

**Notes on the digital signal**

The digital input jacks of this unit can also handle 96-kHz sampling digital signals. (To utilize this, use a source that supports 96-kHz sampling digital signals and set the player for digital output. Refer to the operation instructions for the player.) Note the following when a 96-kHz sampling digital signal is input to this unit:

1. The following indication will appear on the front panel display.



2. DSP programs cannot be selected. Sound will be output as normal 2-channel stereo sound from only the left and right main speakers.

**Note**

- If “1B MAIN SP” on the SET MENU is set to SMALL or “1E LFE/BASS OUT” is set to BOTH, the sound is also output from the subwoofer.
- 3. Adjustment of the speaker output level described on page 45 cannot be made.

**■ BGV (background video) function**

The BGV function allows you to combine a video image from a video source with a sound from an audio source. (For example, you can listen to classical music while you are watching a video.)

Select a source from the video group and then select a source from the audio group with the input selector buttons on the remote control. The BGV function does not work if you select the sources with INPUT ◀/▶ on the front panel.

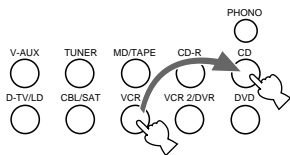

**Remote control**

**Input Modes and Indications**

This unit comes with various input jacks. If your component is connected to more than one type of input jack, you can set the priority of the input signal.

When you turn on the power of this unit, the input mode is set according to “8 INPUT MODE” on the SET MENU (see page 42 for details).

**Press INPUT MODE (or the input selector button that you have pressed to select the input source on the remote control) repeatedly until the desired input mode is shown on the front panel display and on the video monitor.**

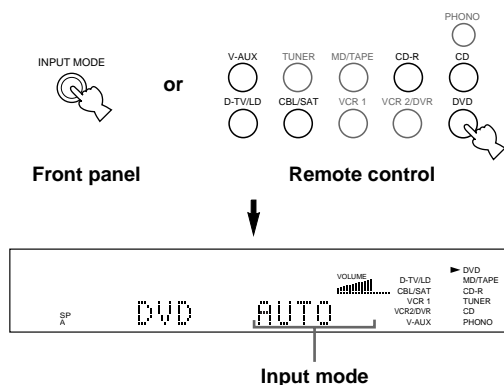

**AUTO:** In this mode, the input signal is automatically selected in the following order:  
 1) Dolby Digital or DTS signal  
 2) Digital (PCM) signal  
 3) Analog signal

**DTS:** In this mode, only the digital input signal encoded with DTS is selected even if another signal is input at the same time.

**ANALOG:** In this mode, only the analog input signal is selected even if a digital signal is input at the same time.

**When LD is selected as the input source (China and general models only)**

**AUTO:** In this mode, this unit automatically selects the signal in the following order:  
 1) Dolby Digital RF signal  
 2) DTS signal  
 3) Digital (PCM) signal  
 4) Analog signal

**D.D. RF:** This unit only selects the Dolby Digital RF signal.

**DTS:** This unit only selects the DTS signal.

**DGTL:** This unit only selects digital (PCM) signal input through the OPTICAL jacks.

**ANALOG:** In this mode, only the analog input signal is selected even if a digital signal is input at the same time.

**Notes**

- If digital signals are input from both the COAXIAL and OPTICAL jacks, the digital signal from the COAXIAL jack is selected.
- When AUTO is selected, this unit automatically determines the type of signal. If this unit detects a Dolby Digital or DTS signal, the decoder automatically switches to the appropriate setting and reproduces 5.1 channel source.
- The sound output may be interrupted for some LD and DVD players in the following situation: The input mode is set to AUTO. A search is performed while playing the disc encoded with Dolby Digital or DTS, and then disc playing is restored. The sound output is interrupted for a moment because the digital signal was selected again.

## ■ Notes on playing a source encoded with a DTS signal

- If the digital output data of the player has been processed in any way, you may not be able to perform DTS decoding even if you make a digital connection between this unit and the player.
- If you play a source encoded with a DTS signal and set the input mode to ANALOG, this unit reproduces the noise of an unprocessed DTS signal. When you want to play a DTS source, be sure to connect the source to a digital input jack and set the input mode to AUTO or DTS.
- If you switch the input mode to ANALOG while playing a source encoded with a DTS signal, this unit reproduces no sound.
- If you play a source encoded with a DTS signal and set the input mode to AUTO, there will be a moment of noise while the unit recognizes the DTS signal and turns on the DTS decoder. This is not a malfunction. You can avoid this by setting the input mode to DTS beforehand.
- If you continue to play a source encoded with a DTS signal with the input mode setting left to AUTO, this unit automatically switches to the “DTS-decoding” mode to prevent noise from being generated during subsequent operation. (The “**dts**” indicator lights up on the front panel display.) The “**dts**” indicator will flash immediately after playback of a source encoded with a DTS signal has finished. Only a source encoded with a DTS signal can be played back while this indicator is flashing. If you want to play a normal PCM source soon, set the input mode back to AUTO.
- The “**dts**” indicator will flash when the input mode is set to AUTO and a search or skip operation is performed while playing back a source encoded with a DTS signal. If this status continues for 30 or more seconds, the unit will automatically switch from the “DTS-decoding” mode to PCM digital signal input mode and the “**dts**” indicator will go out.

## ■ Notes on playing an LD source

- For LD software that does not contain a digital soundtrack, connect the LD player to the analog jacks and set the input mode to AUTO or ANALOG.
- If the LD player is transmitting a signal by a non-standard method, this unit cannot detect the Dolby Digital or DTS signal. In this case, the decoder automatically switches to PCM or analog.
- Some A/V components such as LD players output different audio signals through their analog and digital jacks. Change the input mode as necessary.
- While you are operating the LD player and playing a disc encoded with a Dolby Digital signal, if you switch from the pause or chapter forwarding function to normal playback, you may hear the PCM or analog sound an instant before the Dolby Digital signal is played.
- (China and general models only) See page 14 about the  RF (AC-3) input jack.

## Selecting a Sound Field Program

You can enhance your listening experience by selecting a DSP program. For details about each program, see pages 63 to 66.

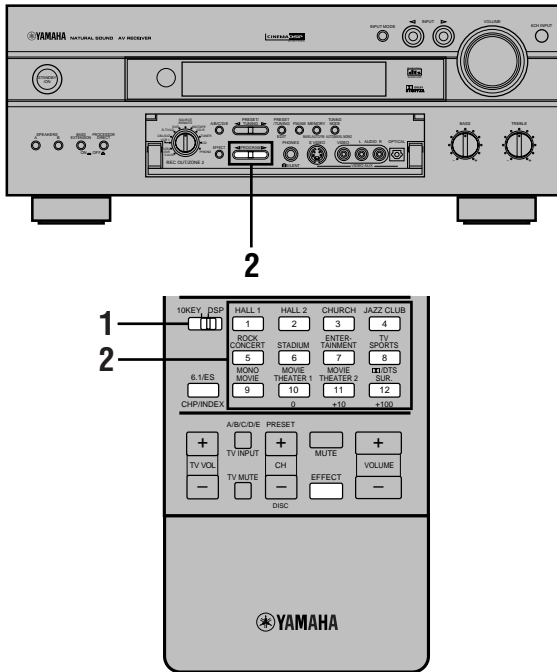

**1** Set 10KEY/DSP to DSP on the remote control.

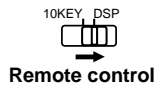

**2** Press one of the DSP program group buttons (or PROGRAM </> on the front panel) repeatedly until the DSP program you want appears on the front panel display and on the video monitor.

For example, to select the sub-program "Spectacle," press MOVIE THEATER 1 repeatedly.

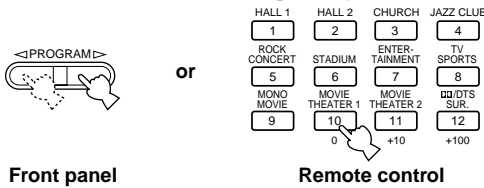

Front panel

Remote control

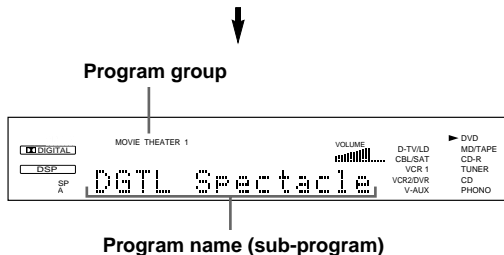

Program group

Program name (sub-program)

## Notes

- Choose a DSP program based on your listening preference, and not on the name of the program. The acoustics of your listening room affect the DSP program. Minimize the sound reflections in your room to maximize the effect created by the program.
- When you select an input source, this unit automatically selects the last DSP program used with that source.
- When you set this unit in the standby mode, the current source and DSP program are memorized and are automatically selected when you turn on the power again.
- If a Dolby Digital or DTS signal is input when the input mode is set to AUTO, the DSP program automatically switches to the appropriate decoding program.
- When a monaural source is being played with PRO LOGIC/Normal or PRO LOGIC/ENHANCED, no sound will be heard from the main speakers and the rear speakers. Sound can only be heard from the center speaker. However, if "1A CENTER SP" on the SET MENU is set to NONE, the center channel sound is output from the main speakers.
- When a source connected to the 6CH INPUT jacks of this unit is selected, the digital sound field processor cannot be used.
- When 96-kHz sampling digital signals are input to this unit, the DSP program cannot be selected. In this case, the sound is reproduced as normal 2-channel stereo.

## Dolby Digital Matrix 6.1 or DTS ES decoder

If you want to utilize the rear center speaker with a 5.1 channel source, press 6.1/ES. However, note that to achieve the proper effect with the rear center channel, the Dolby Digital Surround EX or DTS ES software should be used (see "12 6.1/ES AUTO" on pages 43 and 66 for details).



Remote control

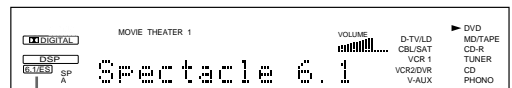

The "6.1/ES" indicator lights up.



## ■ Virtual CINEMA DSP and SILENT CINEMA DSP

You can experience the virtual CINEMA DSP sound field by setting "1C REAR L/R SP" on the SET MENU to NONE. The sound field processing is changed to the Virtual CINEMA DSP mode according to the selected DSP program. Virtual CINEMA DSP is performed by using the main speakers. You can also listen to SILENT CINEMA DSP by connecting your headphones to the PHONES jack while the digital sound field processor is on.

### Note

- This unit is not set in the virtual CINEMA DSP mode even if "1C REAR L/R SP" is set to NONE in the following cases:
  - when the 6ch Stereo, DOLBY DIGITAL/Normal or DTS/Normal program is selected;
  - when the sound effect is turned off;
  - when 6CH INPUT is selected as the input source;
  - when 96-kHz sampling digital signals are input to this unit;
  - when the Dolby Digital KARAOKE source is played;
  - when using the test tone; or
  - when connecting the headphones.

## Normal Stereo Reproduction

**Press EFFECT to turn off the sound effect for normal stereo reproduction.**

Press EFFECT again to turn the sound effect back on.

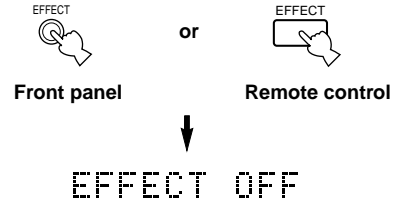

### Notes

- If you turn off the sound effect, no sound is output from the center, rear and rear center speakers.
- If you turn off the sound effect while a Dolby Digital or DTS signal is being output, the dynamic range of the signal is automatically compressed and the sounds of the center, rear and rear center channels are mixed and output from the main speakers.
- The volume may be greatly reduced when you turn off the sound effect or if you set "10B D-RANGE" on the SET MENU to MIN. In this case turn on the sound effect.

# TUNING

## Connecting the Antennas

Both AM and FM indoor antennas are included with this unit. In general, these antennas should provide sufficient signal strength.

Connect each antenna correctly to the designated terminals.

### FREQUENCY STEP switch (China and general models only)



Because the interstation frequency spacing differs in different areas, set the FREQUENCY STEP switch (located at the rear) according to the frequency spacing in your area.

North, Central and South America:  
100 kHz/10 kHz  
Other area: 50 kHz/9 kHz

Before setting this switch, disconnect the AC power plug of this unit from the AC outlet.

### ■ Connecting the AM loop antenna

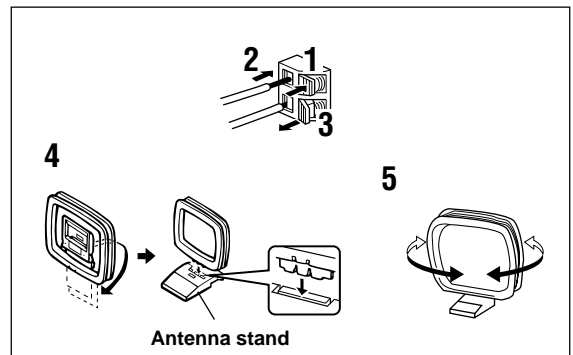

AM loop antenna  
(included)  
(General model)



Indoor FM  
antenna  
(included)

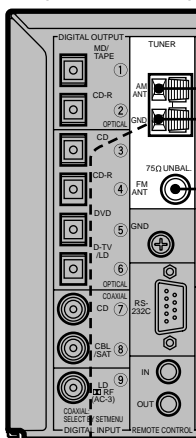

#### Ground (GND terminal)

For maximum safety and minimum interference, connect the antenna GND terminal to a good earth ground. A good earth ground is a metal stake driven into moist earth.

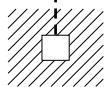

**1** Press and hold the tab to unlock the terminal hole.

**2** Insert the AM loop antenna lead wires into the AM ANT and GND terminals.

**3** Release the tab to lock the lead wires. Lightly pull the lead wires to confirm a good connection.

**4** Attach the loop antenna to the antenna stand.

**5** Orient the AM loop antenna so that the best reception is obtained.



- The AM loop antenna can be removed from the stand and attached to a wall, etc.

#### Notes

- The AM loop antenna should be placed away from this unit.
- The AM loop antenna should always be connected, even if an outdoor AM antenna is connected to this unit.

A properly installed outdoor antenna provides clearer reception than an indoor one. If you experience poor reception quality, an outdoor antenna may improve the quality. Consult the nearest authorized YAMAHA dealer or service center about the outdoor antennas.

### ■ Connecting the indoor FM antenna

Connect the included indoor FM antenna to the 75Ω UNBAL. FM ANT terminal.

#### Note

- Do not connect an outdoor FM antenna and the indoor FM antenna at the same time.

## Automatic (or Manual) Tuning

Automatic tuning is effective when station signals are strong and there is no interference.

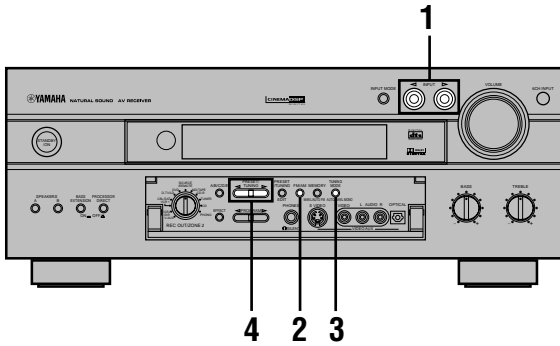

**1** Press INPUT  $\triangleleft/\triangleright$  to select TUNER as the input source.

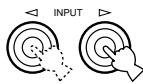

**2** Press FM/AM to select the reception band. "FM" or "AM" appears on the front panel display.

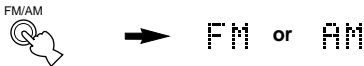

**3** Press TUNING MODE (AUTO/MAN'L MONO) so that the "AUTO" indicator lights up on the front panel display.



If the colon (:) appears on the front panel display next to the band indication, press PRESET/TUNING (EDIT) to turn it off.

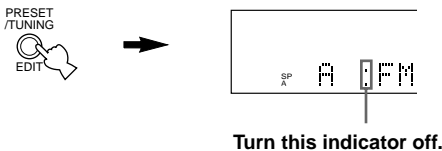

**4** Press PRESET/TUNING  $\triangleleft$  or  $\triangleright$  once to begin automatic tuning.

Press  $\triangleright$  to tune in to a higher frequency, or press  $\triangleleft$  to tune in to a lower frequency. Press the same button again if the tuning search does not stop at the desired station.

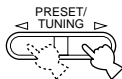

- Use the manual tuning method if the tuning search does not stop at the desired station because the signal is weak.
- When tuned in to a station, the "TUNED" indicator lights up and the frequency of the received station is shown on the front panel display.

If the signal from the station you want to select is weak, you must tune in to it manually.

**3** Press TUNING MODE (AUTO/MAN'L MONO) so that the "AUTO" indicator goes off from the front panel display.

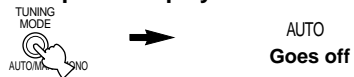

If the colon (:) appears on the front panel display next to the band indication, press PRESET/TUNING (EDIT) to turn it off.

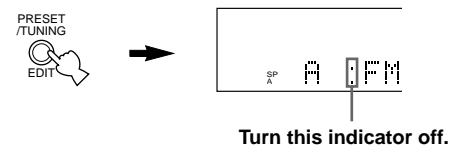

**4** Press PRESET/TUNING  $\triangleleft/\triangleright$  to tune in to the desired station manually.

Hold down the button to continue the tuning search.

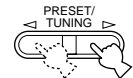

### Note

- Manually tuning in to an FM station will automatically change the reception mode to monaural to increase the signal quality.

## Presetting Stations

### ■ Automatically presetting stations (for FM stations)

You can use the automatic preset tuning feature to store FM stations. This function enables the unit to automatically tune in to FM stations with strong signals, and to store up to 40 (8 stations x 5 groups) of those stations in order. This feature enables you to easily tune in to any preset station by selecting the preset station number (see page 33).

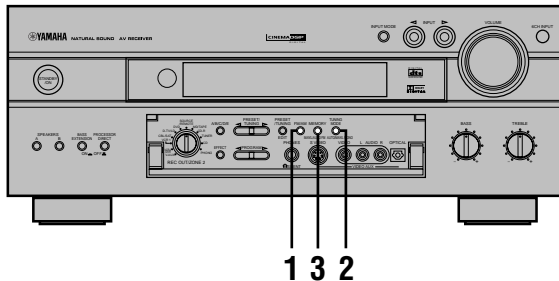

#### 1 Press FM/AM to select the FM band.



#### 2 Press TUNING MODE (AUTO/MAN'L MONO) so that the "AUTO" indicator lights up on the front panel display.



#### 3 Press and hold MEMORY (MAN'L/AUTO FM) for more than 3 seconds.

The preset number, the "MEMORY" and "AUTO" indicators flash. Then, after about 5 seconds, automatic preset tuning begins from the frequency currently displayed toward the higher frequencies.

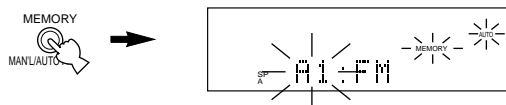

When automatic preset tuning is completed, the front panel display shows the frequency of the last preset station.

### Notes

- Any stored station data existing under a preset number is cleared when you store a new station under that preset number.
- You can manually replace a preset station with another FM or AM station by simply following the procedure in the section "Manually presetting stations" on page 33.
- If the number of the received stations does not reach E8, automatic preset tuning has automatically stopped after searching all stations.
- Only FM stations with sufficient signal strength are stored automatically by automatic preset tuning. If the station you want to store is weak in signal strength, tune in to it manually in the monaural mode, and store it by following the procedure in "Manually presetting stations" on page 33.

### Automatic preset tuning options

You can select the preset number from which the unit will store FM stations and/or begin tuning toward lower frequencies. Before automatic preset tuning begins (after pressing MEMORY in step 3):

- Press A/B/C/D/E and PRESET/TUNING </> to select the preset number under which the first station will be stored. Automatic preset tuning will stop when stations have all been stored up to E8.
- Press PRESET/TUNING (EDIT) to turn off the colon (:), and then press PRESET/TUNING </> to begin tuning toward lower frequencies.

### Memory back-up

The memory back-up circuit prevents the stored data from being lost even if this unit is set in the standby mode, the power cord is disconnected from the AC outlet, or the power supply is temporarily cut due to power failure. However, if the power is cut for more than one week, the preset stations may be cleared. If so, store the stations again by using the presetting station methods.

## Manually presetting stations

You can also store up to 40 stations (8 stations x 5 groups) manually.

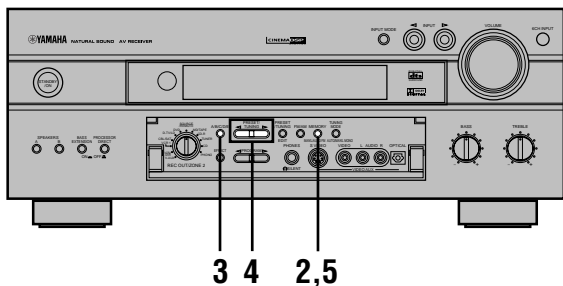

### 1 Tune in to a station.

See page 31 for tuning instructions.

### 2 Press MEMORY (MAN'L/AUTO FM).

The "MEMORY" indicator flashes for about 5 seconds.

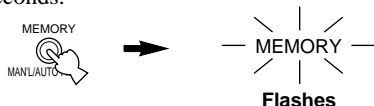

### 3 Press A/B/C/D/E repeatedly to select a preset station group (A to E) while the "MEMORY" indicator is flashing.

The group letter appears and make sure that the colon (:) appears on the front panel display next to the band indication.



### 4 Press PRESET/TUNING </> to select a preset station number (1 to 8) while the "MEMORY" indicator is flashing.

Press > to select a higher preset station number. Press < to select a lower preset station number.

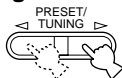

### 5 Press MEMORY (MAN'L/AUTO FM) while the "MEMORY" indicator is flashing.

The station band and frequency appear on the front panel display with the preset group and number you have selected.



Shows the displayed station has been stored as A1.

### 6 Repeat steps 1 to 5 to store other stations.

#### Notes

- Any stored station data existing under a preset number is cleared when you store a new station under that preset number.
- The reception mode (stereo or monaural) is stored along with the station frequency.

## Tuning in to a Preset Station

You can tune any desired station simply by selecting the preset station number under which it was stored.

You can also tune a preset station with the remote control. Press TUNER to select TUNER as the input source.

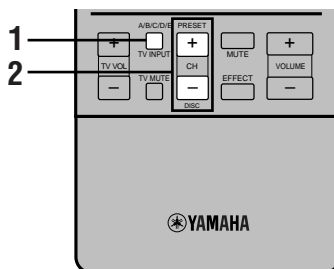
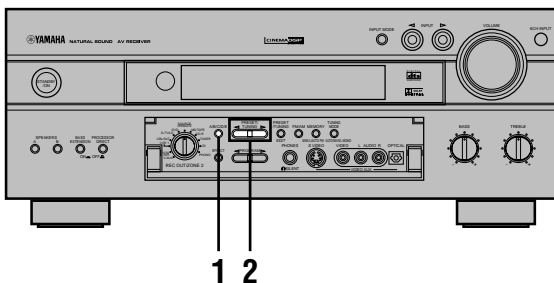

**1 Press A/B/C/D/E to select the preset station group.**

The preset group letter appears on the front panel display and changes each time you press A/B/C/D/E.

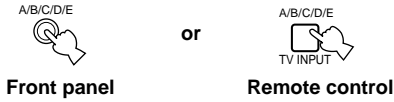

**2 Press PRESET/TUNING </> (or PRESET +/-) to select a preset station number (1 to 8).**

The preset group and number appear on the front panel display along with the station band, frequency and the “TUNED” indicator lights up.

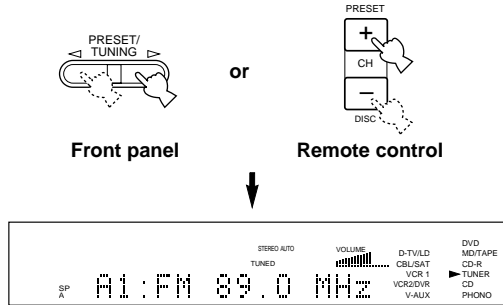

**Exchanging Preset Stations**

You can exchange the assignment of two preset stations with each other. The example below describes the procedure for exchanging preset station “E1” with “A5”.

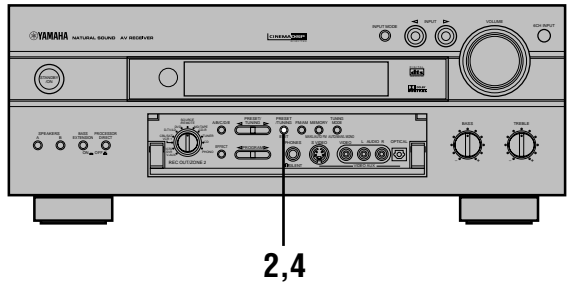

**1 Tune in to preset station “E1”.**

See “Tuning in to a Preset Station” on page 33.

**2 Press and hold PRESET/TUNING (EDIT) for more than 3 seconds.**

“E1” and the “MEMORY” indicator flash on the front panel display.

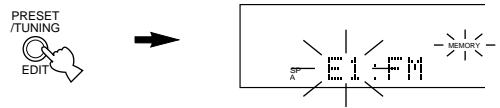

**3 Tune in to preset station “A5” by using the buttons on the front panel.**

“A5” and the “MEMORY” indicator flash on the front panel display.

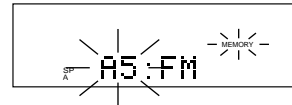

**4 Press PRESET/TUNING (EDIT) again.**

The stations stored at the two preset assignments are exchanged.

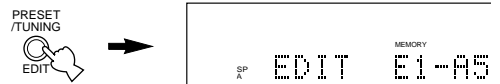

Shows the exchange of stations has been completed.

# BASIC RECORDING

REC OUT/ZONE 2 allows you to record one source while watching and/or listening to another source.

Recording adjustments and other operations are performed from the recording components. Refer to the operation instructions for these components.

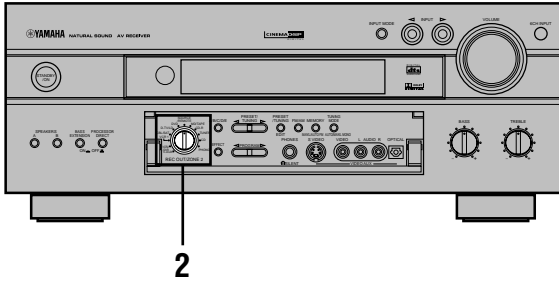

**1** Turn on the power to the unit and all connected components.

**2** Select the source component you want to record from by using REC OUT/ZONE 2.

- To record the current input source, set REC OUT/ZONE 2 to SOURCE/REMOTE.

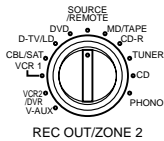

- To record a source that you do not want to simultaneously watch or listen to, set REC OUT/ZONE 2 to the source you want to record.

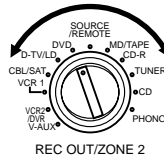

**3** Start playback (or select a broadcast station) on the source component.

**4** Start recording on the recording component.

If you want to listen to another source, and REC OUT/ZONE 2 is not set to SOURCE/REMOTE, select the source you want to reproduce with INPUT ◀ / ▶ and adjust the volume.



- Setting REC OUT/ZONE 2 to SOURCE/REMOTE and using the BGV function (see page 26) allows the recording of audio and video from a different source.

## Notes

- Do a test recording before you start an actual recording.
- When this unit is set in the standby mode, you cannot record between other components connected to this unit.
- The setting of BASS, TREBLE, BASS EXTENSION, VOLUME, “3 L/R BALANCE” on the SET MENU and DSP programs does not affect the recorded material.
- A source connected to the 6CH INPUT jacks of this unit cannot be recorded.
- S-video and composite video signals pass independently through this unit’s video circuits. Therefore, when recording or dubbing video signals, if your video source component is connected to provide only an S-video (or only a composite video) signal, you can record only an S-video (or only a composite video) signal by your VCR.
- A given input source is not output on the same REC OUT channel. (For example, the signal input from VCR 1 IN is not output on VCR 1 OUT.)
- Check the copyright laws in your country to record from records, CDs, radio, etc. Recording of copyrighted material may infringe copyright laws.

If you playback a video source that uses scrambled or encoded signals to prevent it from being dubbed, the picture itself may be disturbed due to those signals.

## Special considerations when recording DTS software

The DTS signal is a digital bitstream. Attempting to digitally record the DTS bitstream will result in noise being recorded. Therefore, if you want to use this unit to record sources that have DTS signals recorded on them, the following considerations and adjustments need to be made.

### For LDs, DVDs and CDs encoded with DTS

Only 2-channel analog audio signals may be recorded as follows:

- LDs**  
Set your LD player’s left and right outputs to the analog soundtrack.
- DVDs**  
Use the disc menu to set the DVD player’s mixed 2-channel left and right audio outputs to the PCM or Dolby Digital soundtrack.
- CDs**  
The DTS signal recorded on CDs can only be output as a digital bitstream, and therefore cannot be recorded.

# SET MENU

The SET MENU consists of 15 items including the speaker mode setting, center graphic equalizer and parameter initialization features. Choose the appropriate item and adjust or select the values as necessary.



- You can adjust the items on the SET MENU while playing a source.
- We recommend that you adjust the items on the SET MENU while using a video monitor. It is easier to see the video monitor than it is to see the front panel display on this unit while adjusting the items.

## Note

- The indication on the front panel display is the abbreviation of the OSD.

- 1 **SPEAKER SET**
  - 1A CENTER SP
  - 1B MAIN SP
  - 1C REAR L/R SP
  - 1D REAR CT SP
  - 1E LFE/BASS OUT
  - 1F MAIN LEVEL
- 2 **LOW FRQ TEST**
- 3 **L/R BALANCE**
- 4 **HP TONE CTRL**
- 5 **CENTER GEQ**
- 6 **INPUT RENAME**
- 7 **I/O ASSIGNMENT**
- 8 **INPUT MODE**
- 9 **PARAM. INI**
- 10 **DOLBY D. SET**
  - 10A LFE LEVEL
  - 10B D-RANGE
- 11 **DTS LFE LEVEL**
- 12 **6.1/ES AUTO**
- 13 **SP DELAY TIME**
- 14 **DISPLAY SET**
- 15 **MEMORY GUARD**

## Adjusting the Items on the SET MENU

Adjustment should be made with the remote control.

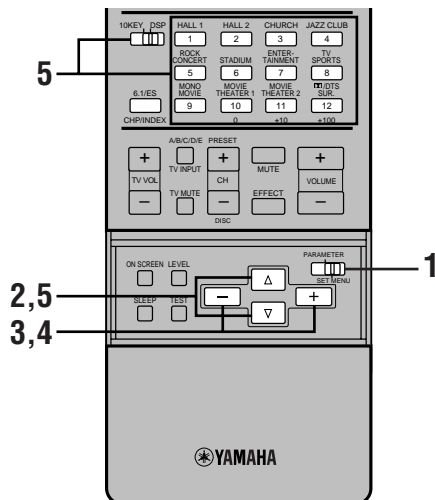

## Note

- Some items require extra steps to change to the desired setting.

**1** Set **PARAMETER/SET MENU** to **SET MENU**.



**2** Press  $\Delta$  /  $\nabla$  repeatedly to select the item (1 to 15) you want to adjust.

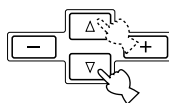

### SET MENU 1/4

- 1 SPEAKER SET
- 2 LOW FRQ TEST
- 3 L/R BALANCE
- 4 HP TONE CTRL
- $\Delta$  /  $\nabla$  : Up/Down
- /+ Enter

**3** Press **-** or **+** once to enter the setup mode of the selected item.

The last setting you adjusted appears on the video monitor or on the front panel display.

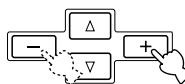

### 2 LOW FRQ TEST

- TEST TONE ..... OFF
- OUTPUT ... MAIN L/R
- FRQ ..... 88Hz



Depending on the item, press  $\Delta$  /  $\nabla$  to select a sub item.

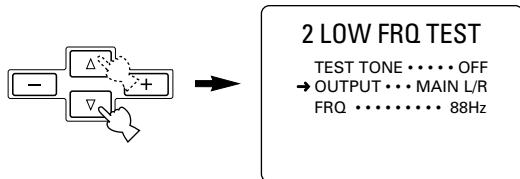

**4 Press -/+ repeatedly to change the setting of the item.**

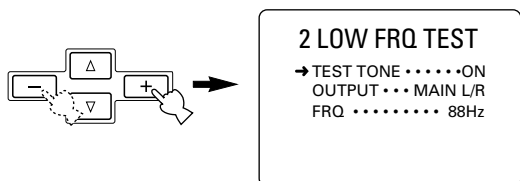

**5 Press  $\Delta$  /  $\nabla$  repeatedly until the current DSP program appears or simply press one of the DSP program group buttons to exit from the SET MENU.**

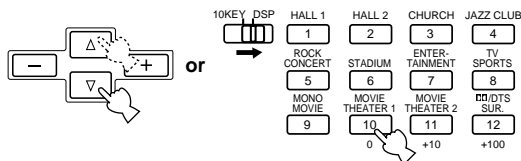

**Memory back-up**

The memory back-up circuit prevents the stored data from being lost even if this unit is set in the standby mode, the power cord is disconnected from the AC outlet, or the power supply is temporarily cut due to power failure. However, if the power is cut for more than one week, the settings of the SET MENU you adjusted will return to the factory settings. If so, adjust the items again.

**1 SPEAKER SET (speaker mode settings)**

Use this feature to select suitable output modes for your speaker configuration. You must set the output mode when you use a subwoofer.

**Notes**

- When 96-kHz sampling digital signals are input to this unit, level adjustments in items 1B and 1E are possible, but those in items 1A, 1C, 1D and 1F are not affected.
- When 6CH INPUT is selected as the input source, level adjustments in items 1A through 1F are not affected.

**1A CENTER SP (center speaker mode)**

By adding a center speaker to your speaker configuration, the unit can provide good dialog localization for many listeners and superior synchronization of sound and images. The OSD shows a large, small or no center speaker depending on how you set this item.

Choices: LRG (large), SML (small), NONE  
Initial setting: LRG

**LRG**

Select this if you have a large center speaker. The entire range of the center channel signal is directed to the center speaker.

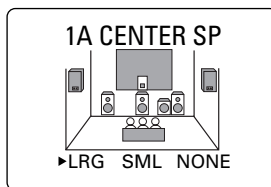

**SML**

Select this if you have a small center speaker. The low-frequency signals (90 Hz and below) of the center channel are directed to the speakers selected with "1E LFE/BASS OUT".

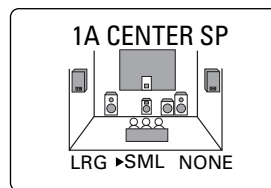

**NONE**

Select this if you do not have a center speaker. All of the center channel signals are directed to the left and right main speakers.

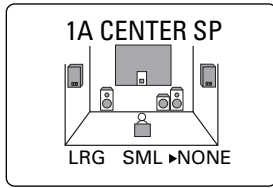

**1B MAIN SP (main speaker mode)**

The OSD shows large or small main speakers depending on how you set this item.

Choices: LARGE, SMALL

Initial setting: LARGE

**LARGE**

Select this if you have large main speakers. The entire range of the left and right main channel signal is directed to the left and right main speakers.

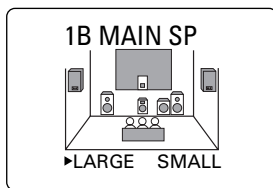

**SMALL**

Select this if you have small main speakers. The low-frequency signals (90 Hz and below) of the main channel are directed to the speakers selected with "1E LFE/BASS OUT".

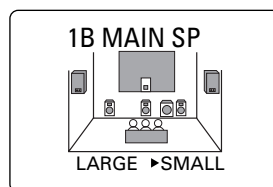

**Note**

- When you select MAIN for "1E LFE/BASS OUT", the low-frequency signals (90 Hz and below) of the main channel are directed to the main speakers even if you select SMALL for the main speaker mode.

**1C REAR L/R SP (rear speaker mode)**

The OSD shows large, small or no rear speakers depending on how you set this item.

Choices: LRG (large), SML (small), NONE

Initial setting: LRG

**LRG**

Select this if you have large left and right rear speakers or if a rear subwoofer is connected to the rear speakers. The entire range of the rear channel signal is directed to the left and right rear speakers.

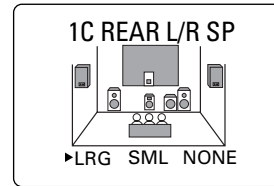

**SML**

Select this if you have small left and right rear speakers. The low-frequency signals (90 Hz and below) of the rear channel are directed to the speakers selected with "1E LFE/BASS OUT".

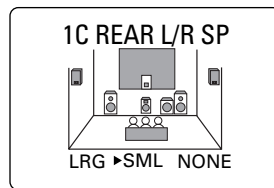

**NONE**

Select this if you do not have rear speakers. In this case, the rear center speaker mode will automatically be set to NONE and "1D REAR CT SP" will be skipped.

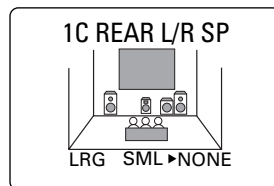

- This unit is set in the virtual CINEMA DSP mode by selecting NONE for "1C REAR L/R SP".

## ■ 1D REAR CT SP (rear center speaker mode)

By adding a rear center speaker to your speaker configuration, the unit can provide more realistic front-to-back and back-to-front transitions.

Choices: LRG (large), SML (small), NONE

Initial setting: NONE

### LRG

Select this if you have a large rear center speaker. The entire range of the rear center channel signal is directed to the rear center speaker.

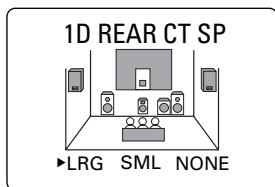

### SML

Select this if you have a small rear center speaker. The low-frequency signals (90 Hz and below) of the rear center channel are directed to the speakers selected with "1E LFE/BASS OUT".

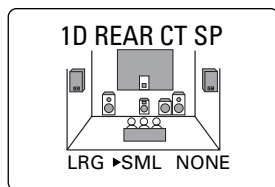

### NONE

Select this if you do not have a rear center speaker. All of the rear center channel signals are directed to the left and right rear speakers.

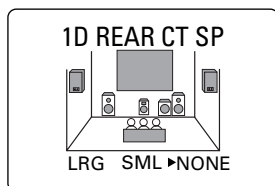

## ■ 1E LFE/BASS OUT (bass out mode)

LFE signals carry low-frequency effects when this unit decodes a Dolby Digital or DTS signal. Low-frequency signals are defined as 90 Hz and below.

Choices: SWFR (subwoofer), MAIN, BOTH

Initial setting: BOTH

### SWFR

Select this if you use a subwoofer. The LFE signals are directed to the subwoofer.

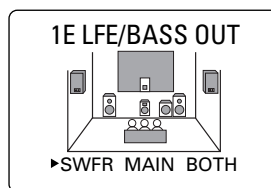

### MAIN

Select this if you do not use a subwoofer. The LFE signals are directed to the main speakers.

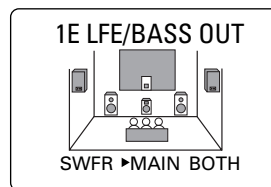

### BOTH

Select this if you use a subwoofer and you want to mix the main channel low-frequency signals with the LFE signals.

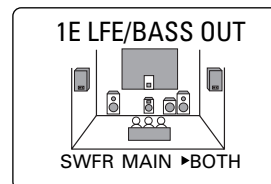

### Note

- The low-frequency signals (90 Hz and below) from all main, center, rear and rear center (see page 17) channels are directed to the LFE channel when you select the small speaker setting in items 1A, 1B, 1C and 1D.

## 1F MAIN LEVEL (main level mode)

Change this setting if you cannot match the output level of the center and rear speakers with the main speakers because of the unusually high-efficiency performance of the main speakers.

Choices: Normal, -10 dB

Initial setting: Normal

### Normal

Select this if you can match the output level of your effect speakers with that of your main speakers when using the test tone.

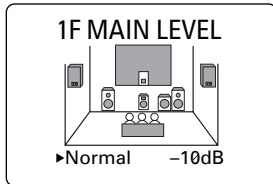

### -10 dB

Select this if you cannot match the output level of your effect speakers with that of your main speakers when using the test tone.

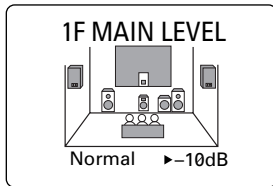

## 2 LOW FRQ TEST

Use this feature to adjust the output level of the subwoofer so it matches that of the other speakers in your configuration. Change the setting with the remote control while sitting in the listening position.

**1** Press **-/+** to set “TEST TONE” to ON, and adjust the volume with **VOLUME +/-** so you can hear the tone.

### Notes

- Do not turn up the volume too high.
- If no test tone is heard, turn down the volume, set this unit in the standby mode and make sure all the necessary connections are correct.

**2** Press **∇** to go to “OUTPUT” and press **-/+** to select the speaker you want to compare with the subwoofer.

If SWFR is selected, the test tone above 90 Hz will not be output from the subwoofer. The test tone will not necessarily be output from the selected speakers. The output mode of the test tone depends on the settings of “1 SPEAKER SET” on the SET MENU.

**3** Press **∇** to go to “FRQ” and press **-/+** to select the frequency you want to use.

**4** Adjust the volume of the subwoofer with the controls on the subwoofer so it matches that of the speaker you are comparing it to.

## About the test tone

The test tone is produced by the tone generator. The tone generator produces a narrow-band noise centered on a specified frequency by the band pass filter. You can change this center frequency from 35 Hz through 250 Hz in one-sixth octave steps.

You can use the test tone not only for adjusting the subwoofer level, but also for checking the low-frequency characteristics of your listening room. Low-frequency sounds are especially affected by the listener’s position, speaker placement, subwoofer polarity and other conditions.

Digital generator  
(wide band noise produced)

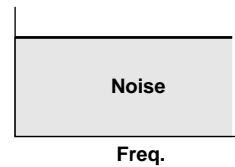

Center freq. 35 Hz – 250 Hz

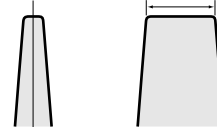

Band pass filter

### 3 L/R BALANCE (balance of the left and right main speakers)

Use this feature to adjust the balance of the output level from the left and right main speakers.

Control range: 10 steps for L/R

Initial setting: 0

**Press + to decrease the output level for the left main speaker. Press – for the right main speaker.**

### 4 HP TONE CTRL (headphone tone control)

Use this feature to adjust the level of the bass and treble when you use your headphones.

Control range (dB): –6 to +3

Initial setting: 0 dB for both BASS and TRBL (treble)

### 5 CENTER GEQ (center graphic equalizer)

Use this feature to adjust the built-in 5-band graphic equalizer so that the center speaker tonal quality matches that of the left and right main speakers. You can select the 100 Hz, 300 Hz, 1 kHz, 3 kHz, or 10 kHz frequencies.

Control range (dB): –6 to +6

Initial setting: 0 dB for 5-band

**1 Press ▾ to select a higher frequency and ▲ to select a lower frequency.**

**2 Press –/+ to adjust the level of that frequency.**



- You can monitor the center speaker sound while adjusting this item by using the test tone. Press TEST before starting the foregoing procedure. "TEST DOLBY SUR." appears on the video monitor, and the test tone starts alternating among the speakers. Once you begin this procedure, the test tone remains at the center speaker and you can hear how the sound changes as you adjust the various frequency levels. To stop the test tone, press TEST (see pages 22 and 23).

### 6 INPUT RENAME

Use this feature to change the name of the input which appears on the OSD or the front panel display.

**1 Press an input selector button (or use INPUT </>) to select the input you want to change the name of.**

**2 Press –/+ to place the \_ (under-bar) under the space or the character you want to edit.**

**3 Press ▲ / ▽ to select the character you want to use and –/+ to move to the next one.**

- Press ▽ to change the character in the following order, or press ▲ to go in the reverse order. A to Z, a space, 0 to 9, a space, a to z, a space, #, \*, +, and so on.
- Follow the foregoing procedure to rename other inputs.

#### Note

- You can use up to 8 characters to rename the inputs.

**4 Press + repeatedly to exit from INPUT RENAME.**

### 7 I/O ASSIGNMENT

Use this feature to designate the input for the COMPONENT jacks (A and B) and the DIGITAL INPUT/OUTPUT jacks (① to ⑧ (or ⑨ for the China and general models only)) to any sources you want.

**■ 7A [A] [B] (for the COMPONENT VIDEO jacks)**

Initial settings: [A] DVD  
[B] D-TV/LD

**■ 7B (1) (2) (for the OPTICAL OUTPUT jacks)**

Initial settings: (1) MD/TAPE  
(2) CD-R

**■ 7C (3) to (6) (for the OPTICAL INPUT jacks)**

Initial settings: (3) CD  
(4) CD-R  
(5) DVD  
(6) D-TV/LD

**■ 7D (7) (8) (9 (China and general models only)) (for the COAXIAL INPUT jacks)**

Initial settings: (7) CD  
(8) CBL/SAT  
(9) LD RF

#### Note

- You cannot select an item more than once for the same type of jack.

## 8 INPUT MODE (initial input mode)

Use this feature to designate the input mode for sources connected to the DIGITAL INPUT jacks when you turn on this unit (see page 26 for details about the input mode).

Choices: AUTO, LAST  
Initial setting: AUTO

### AUTO

Select this to allow this unit to automatically detect the type of input signal and select the appropriate input mode.

### LAST

Select this to set this unit to automatically select the last input mode used for that source.

## 9 PARAM. INI (parameter initialization)

Use this feature to initialize the parameters for each DSP program within a DSP program group. When you initialize a DSP program group, all of the parameter values within that group revert to their initial settings.

**Press the DSP program group button on the remote control for the DSP program you want to initialize.**

All of the DSP programs within the selected program group are initialized.



- The asterisk mark (\*) next to a DSP program group number indicates that you have changed the parameter values in one or more DSP programs within that group.

### Notes

- You cannot initialize the individual DSP programs within a group separately.
- The parameter values of the DSP programs do not change if you initialize a program group that does not have the asterisk mark (\*).
- When "15 MEMORY GUARD" is set to ON (see page 44), you cannot initialize any program groups.
- Once you initialize a DSP program group, you cannot automatically revert to the previous parameter settings.

## 10 DOLBY D. SET (Dolby Digital set)

This setting is effective only when this unit decodes Dolby Digital signals.

### 10A LFE LEVEL

Use this feature to adjust the output level of the LFE (low-frequency effect) channel when playing back a Dolby Digital signal. The LFE signal carries the low-frequency special effect sound which is only added to certain scenes.

Control value (dB): -20 to 0

Initial setting: 0 dB for both SPEAKER and HEADPHONE

### Note

- Adjust the LFE level according to the capacity of your subwoofer or headphones.

### 10B D-RANGE (dynamic range)

Use this feature to adjust the dynamic range.

Choices: MAX, STD (standard), MIN

Initial setting: MAX for both SP (speaker) and HP (headphones)

- Select MAX for feature films.
- Select STD for general use.
- Select MIN for listening to sources at an extremely low volume level.

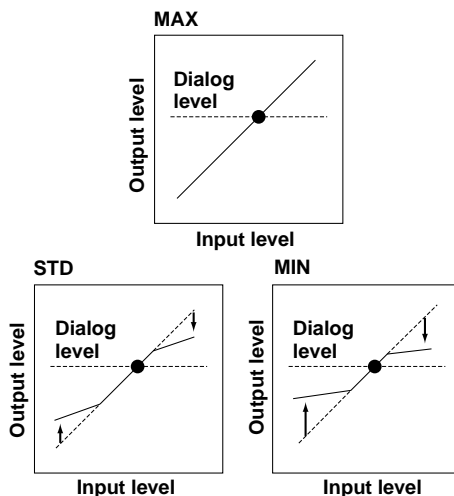

### Note

- When you select MIN, the sound output may be faint because some Dolby Digital signals are not compatible with the minimum-level dynamic range. In this case, select MAX or STD.

## 11 DTS LFE LEVEL

This setting is effective only when this unit decodes DTS signals.

Use this feature to adjust the output level of the LFE (low-frequency effect) channel when playing back a DTS signal. The LFE signal carries the low-frequency special effect sound which is only added to certain scenes.

Control range (dB): -10 to +10

Initial setting: 0 dB for both SPEAKER and HEADPHONE

### Note

- Adjust the LFE level according to the capacity of your subwoofer or headphones.

## 12 6.1/ES AUTO

Use this feature to switch the audio mode of the Dolby Digital Matrix 6.1 or DTS ES decoder on or off.

Choices: ON, OFF

Initial setting: ON

### ON

Select this to allow this unit to automatically turn on the Dolby Digital Matrix 6.1 or DTS ES decoder when a signal with the appropriate identification is detected.

### OFF

Select this if you want to turn on or off the Dolby Digital Matrix 6.1 or DTS ES decoder manually by pressing 6.1/ES on the remote control.

## 13 SP DELAY TIME

Use this feature to adjust the delay of the center and rear center channel sounds. This feature works when this unit decodes a Dolby Digital or DTS signal. Ideally, the center speaker and rear center speaker should be the same distance from the listening position as the left and right main speakers. However, in most home situations, the center speaker or the rear center speaker is placed in line with the main speakers or rear speakers. By delaying the sound from the center speaker and the rear center speaker, the apparent distance from the center speaker and the rear center speaker to the listening position can be adjusted to make it seem the same as the distance between the left and right main speakers and the left and right rear speakers to the listening position. Adjusting the delay time for the center speaker is especially important for giving depth to the dialog.

Control range (ms): 0 to 5 for the center speaker  
0 to 30 for the rear center speaker

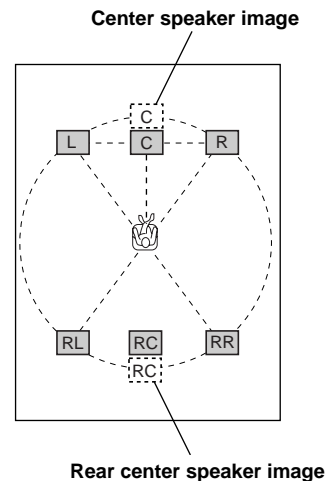

- Increasing the delay by 1 ms simulates moving the speakers about 30 cm (one foot) farther away from the listening position.

## 14 DISPLAY SET

### ■ BLUE BACK > AUTO/OFF

You can set the OSD background to blue if the video source is not being reproduced (or the power of the source component is off).

### ■ OSD SHIFT (OSD off-set position)

This setting is used to adjust the vertical position of the OSD.

### ■ DIMMER

You can adjust the brightness of the front panel display.

## 15 MEMORY GUARD

Use this feature to prevent accidental changes to DSP program parameter values and other settings on this unit.

Choices: ON, OFF

Initial setting: OFF

Select ON to protect the following features:

- DSP program parameters
- All SET MENU items
- Center, rear, rear center (see page 17) speakers and subwoofer levels
- The on-screen display (OSD) mode

### Notes

- When “15 MEMORY GUARD” is set to ON, you cannot use the test tone.
- When “15 MEMORY GUARD” is set to ON, you cannot select any other SET MENU items.



# ADJUSTING THE LEVEL OF THE EFFECT SPEAKERS

You can adjust the output level of each effect speaker (center, left and right rear, rear center (see page 17) and subwoofer) while listening to a music source.

Adjustment should be made with the remote control.

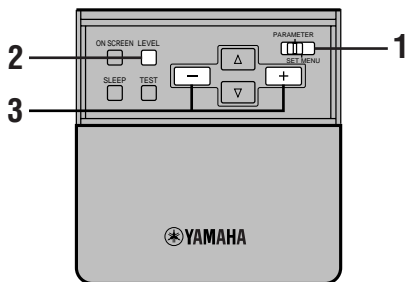

## 1 Set PARAMETER/SET MENU to PARAMETER.



## 2 Press LEVEL repeatedly to select the speaker(s) you want to adjust.

Each time you press LEVEL, the selected speaker changes and appears on the front panel display and on the video monitor as follows: center, right rear, rear center (see page 17), left rear and subwoofer.

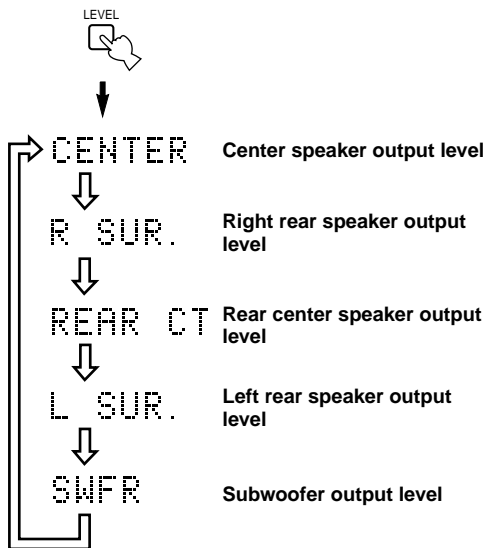

- Once you press LEVEL, you can also select the speaker(s) to be adjusted by pressing  $\nabla$ . (Pressing  $\Delta$  changes the selection in the reverse order.)

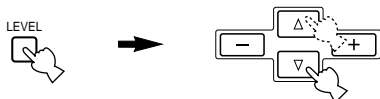

## 3 Press $\pm$ to adjust the speaker output level.

- The control range for the center, left and right rear or rear center speakers is from +10 dB to -10 dB.
- The control range for the subwoofer is from 0 dB to -20 dB.

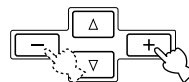

- When PARAMETER/SET MENU is set to SET MENU, you cannot adjust the output level by using LEVEL. However, each time you press LEVEL, the current level of each speaker appears on the front panel display and you can check the speaker level.

### Notes

- If the speaker output mode is set to NONE, the output level of that speaker cannot be adjusted.
- When you adjust the output level with LEVEL, the settings you made with the test tone will be changed.

### Memory back-up

The memory back-up circuit prevents the stored data from being lost even if this unit is set in the standby mode, the power cord is disconnected from the AC outlet, or the power supply is temporarily cut due to power failure. However, if the power is cut for more than one week, the output level of the effect speakers you adjusted will return to the factory settings. If so, adjust the output level again.

# SLEEP TIMER

Use this feature to automatically set this unit in the standby mode after the amount of time you have set. The sleep timer is useful when you are going to sleep while this unit is playing or recording a source. The sleep timer also automatically turns off the external components connected to AC OUTLET(S).

The sleep timer can only be set with the remote control.



- By connecting a commercially available timer to this unit, you can also set a wake-up timer. Refer to the operation instructions for the timer.

## Setting the Sleep Timer

- 1 Select a source and start playback on the source component.
- 2 Press SLEEP repeatedly to set the amount of time before this unit automatically turns off.

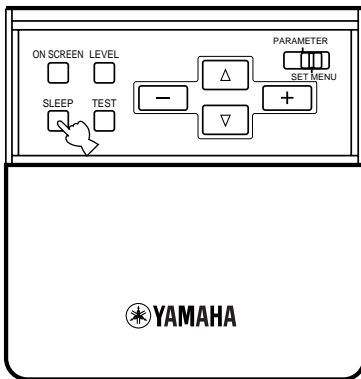

Each time you press SLEEP, the front panel display changes as shown below.

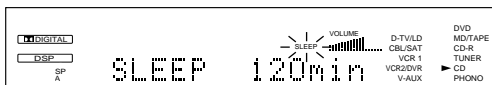
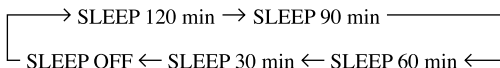

- 3 The "SLEEP" indicator soon lights up on the front panel display after the sleep timer has been set.

The display then returns to the previous indication.



## Canceling the Sleep Timer

Press SLEEP repeatedly until "SLEEP OFF" appears on the front panel display.

After a few seconds, "SLEEP OFF" disappears, the "SLEEP" indicator goes off and the display returns to the previous indication.



- The sleep timer setting can also be canceled by setting this unit in the standby mode by using STANDBY on the remote control (or STANDBY/ON on the front panel) or by disconnecting the AC power cord from the AC outlet.

# REMOTE CONTROL FEATURES

The remote control can operate this unit as well as other YAMAHA A/V components. To control the components from other manufacturers (or some from YAMAHA), you must set up the remote control with the manufacturer codes.

This remote control also has two sophisticated features: Learn and Macro. The Learn feature allows it to acquire functions from the remote controls of other components in your system (or other household appliances) equipped with an infrared remote control receiver. The Macro feature allows you to program a series of operations in sequence for operation by a single button, or to use the factory-set macros to operate other YAMAHA components. These features make it possible for you to reduce the number of remote control in your entertainment room.

## Notes

- For the operating distance of the remote control and notes about batteries, see pages 3 and 8.
- For the name and function of each part and button, see pages 6 and 7.
- If the memory on the remote control becomes full, no further learning is possible, even if there are still some programmable buttons available (see page 56).

## Control Area

### Control area of this unit

The control area of this unit is the shaded area shown below. You can use the functions within this area no matter which component control area is selected.

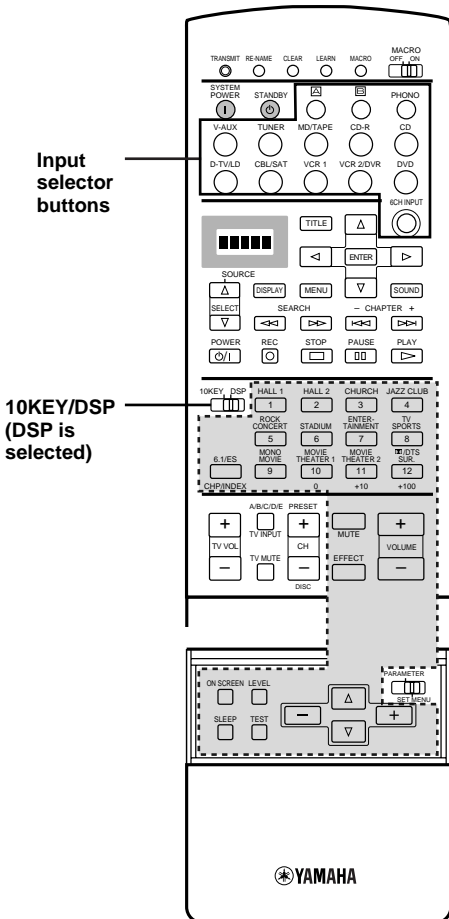

Input selector buttons

10KEY/DSP (DSP is selected)

### Component control area

The component control area is the shaded area shown below. Each component has different functions for the operation buttons in the component control area. The component which has been chosen by pressing an input selector button can be controlled and the display window shows the corresponding name of the input.

These buttons switch the control area  
Factory settings:  
A for the LD player and B for the satellite tuner.

Input selector buttons and these buttons also switch the control area for each component

10KEY/DSP (10KEY is selected)

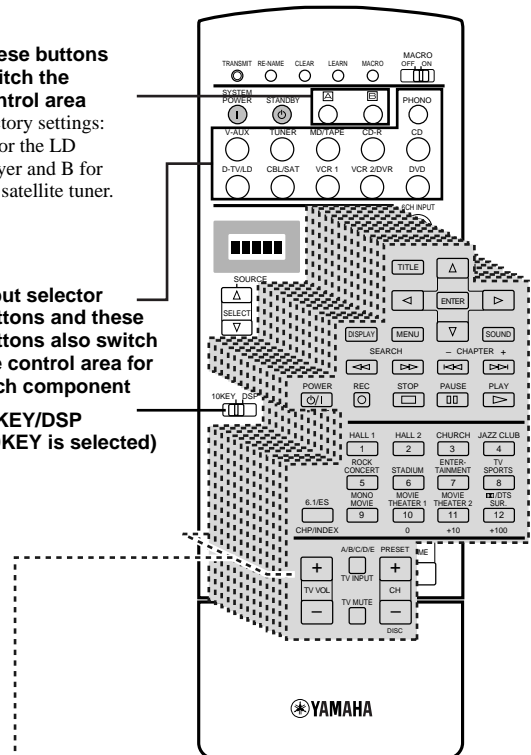

### Component control area

There are 14 component control areas. You can set up the manufacturer code and program other remote control functions in each area (you cannot set up the manufacturer code in the OPTN area). See pages 54 to 56.

ADVANCED OPERATION

English

## ■ SOURCE SELECT $\Delta$ / $\nabla$

You can control another component independently from the input you have selected by pressing an input selector button.

**Press SOURCE SELECT  $\Delta$  /  $\nabla$  to choose the component and set the remote control to be used for it.**

The display window will show one of the following: (when pressing  $\nabla$ ) OPTN (option), A, B, PHONO, V-AUX, TUNER, MD, CD-R, CD, TV/LD (TV or digital TV/LD), CBSAT (cable TV/satellite tuner), VCR 1, VCR 2, DVD.



- Pressing  $\Delta$  shows the same in the reverse order, but you cannot select OPTN.

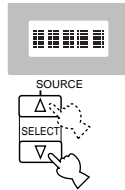

## ■ OPTN (option) area

OPTN is an extra component control area that can be programmed with other remote control functions.

### Note

- You cannot set up the manufacturer code in this area. See page 53 for the programmable area.

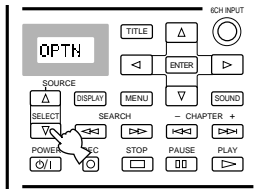

Pressing  $\nabla$  always selects OPTN first

## ■ Zone 2 feature

When you make up a second audio-video room with this unit's Zone 2 feature, you must set "Zone2" as the amplifier library in the remote control first. Selecting "Zone2" by pressing  $\Delta$  sets the remote control to the Zone 2 mode. See pages 61 and 62 for details.

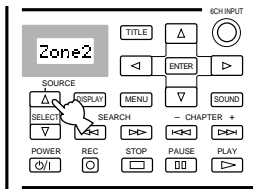

Pressing  $\Delta$  selects "Zone2" first

## Each Component Control Area

The general operational buttons are shown for each area. Some of them may not function depending on the component you have.

First, press an input selector button or SOURCE SELECT  $\Delta / \nabla$  to select a component you want to control.



- The YAMAHA code is factory set for the A, TUNER, MD/TAPE, CD, CD-R and DVD buttons. You must set up the manufacturer code when operating your component (see page 54).

### Operating a tuner (TUNER area)

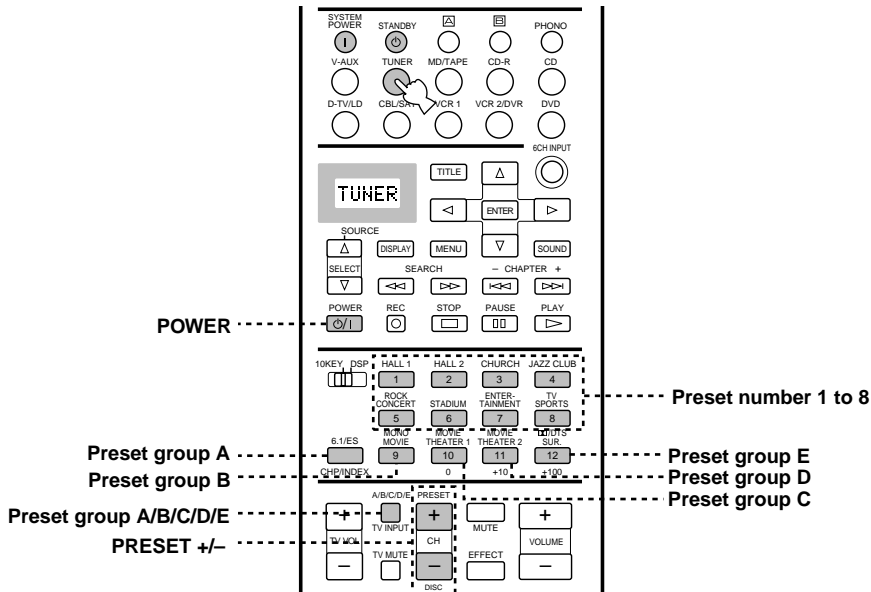

### Operating a CD player (CD area)

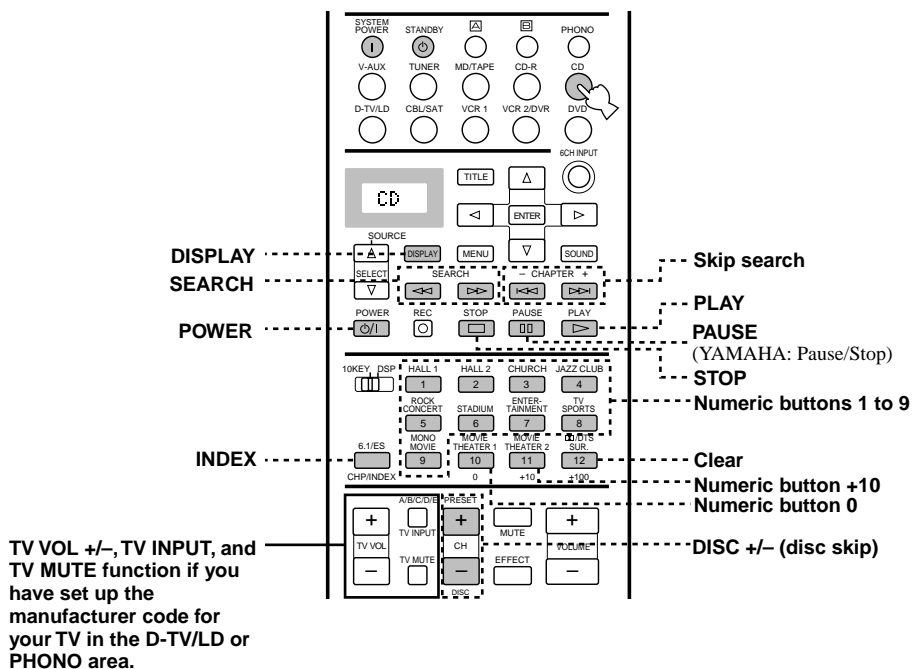

#### Note

- When the manufacturer code for your TV is set up in the both D-TV/LD and PHONO areas, priority is given to the signal in the D-TV/LD area.

## ■ Operating an MD recorder (MD/TAPE area)

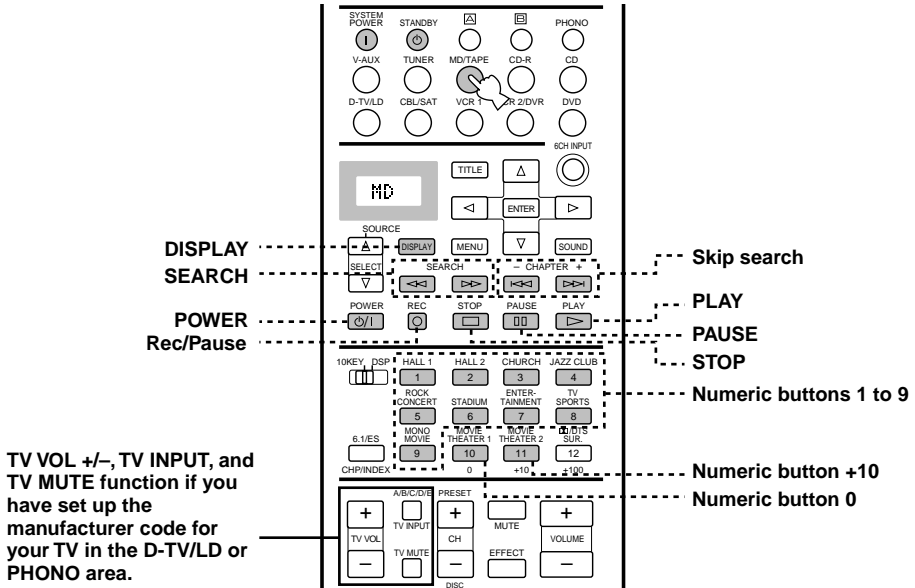

### Note

- When the manufacturer code for your TV is set up in the both D-TV/LD and PHONO areas, priority is given to the signal in the D-TV/LD area.

## ■ Operating a CD recorder (CD-R area)

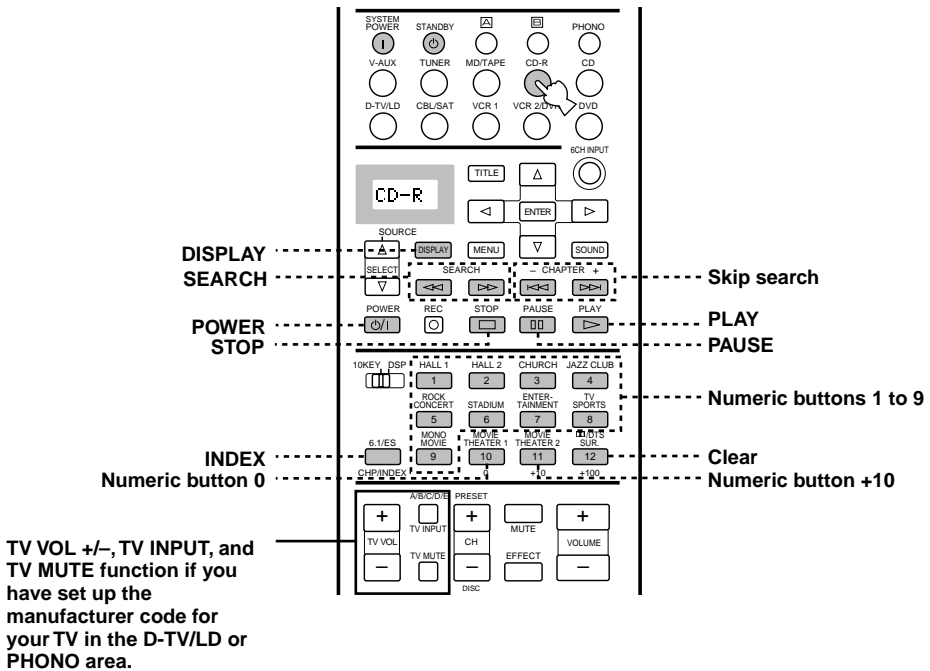

### Note

- When the manufacturer code for your TV is set up in the both D-TV/LD and PHONO areas, priority is given to the signal in the D-TV/LD area.

## ■ Operating an LD player (A area)

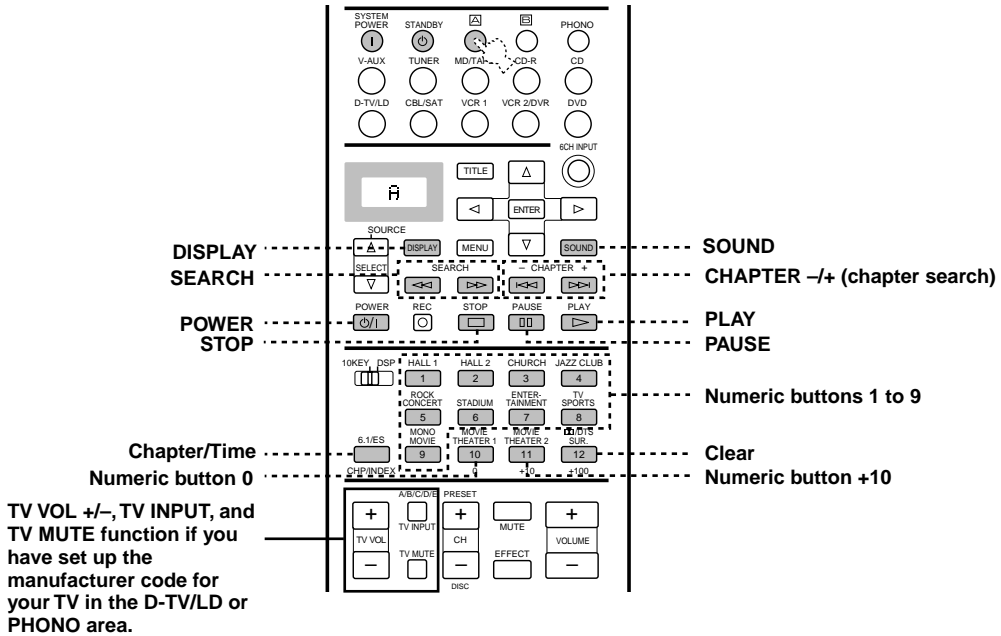

### Notes

- The A button is not the input selector and only switches the component area for operating an LD player.
- When the manufacturer code for your TV is set up in the both D-TV/LD and PHONO areas, priority is given to the signal in the D-TV/LD area.

## ■ Operating a DVD player (DVD area)

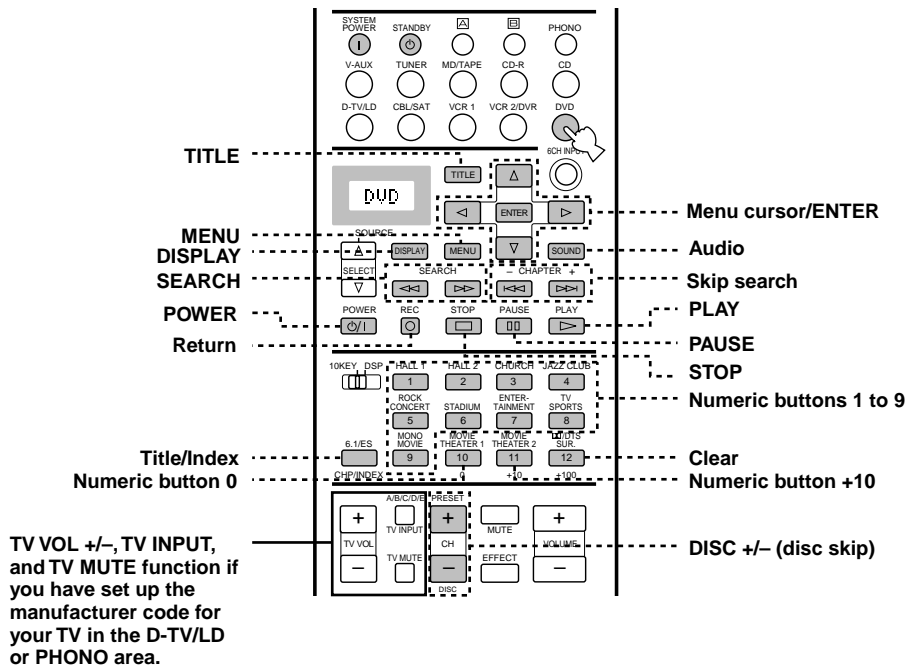

### Note

- When the manufacturer code for your TV is set up in the both D-TV/LD and PHONO areas, priority is given to the signal in the D-TV/LD area.

## ■ Operating a VCR (VCR 1, VCR 2/DVR and V-AUX areas)

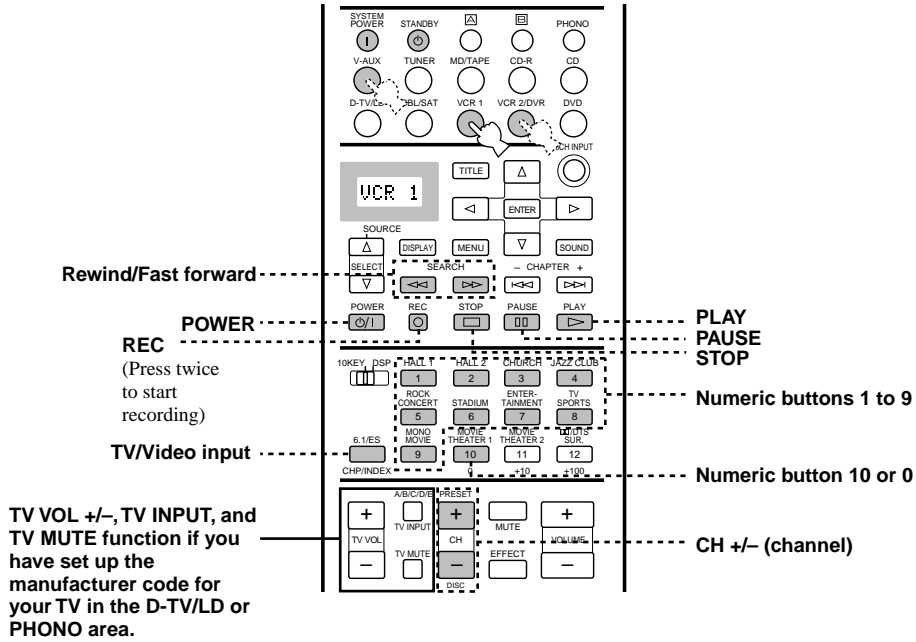

**Note**

- When the manufacturer code for your TV is set up in the both D-TV/LD and PHONO areas, priority is given to the signal in the D-TV/LD area.

## ■ Operating a TV/digital TV (D-TV/LD and PHONO areas)

**Note**

- If you operate an LD player in the D-TV/LD area, set the manufacturer code for your LD player in D-TV/LD area, and the manufacturer code for your TV in PHONO area.

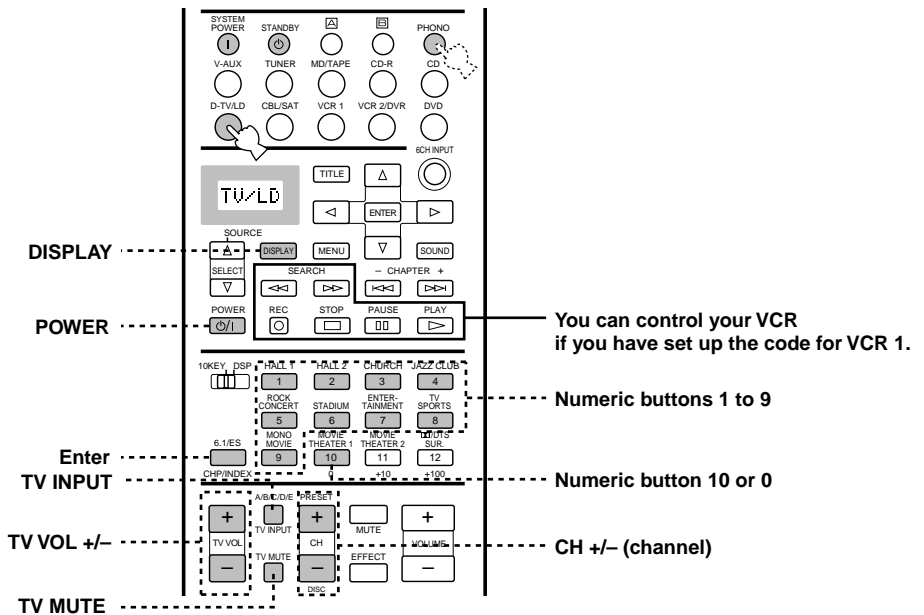



## ■ Operating a cable TV (CBL/SAT area) or satellite tuner (B area)

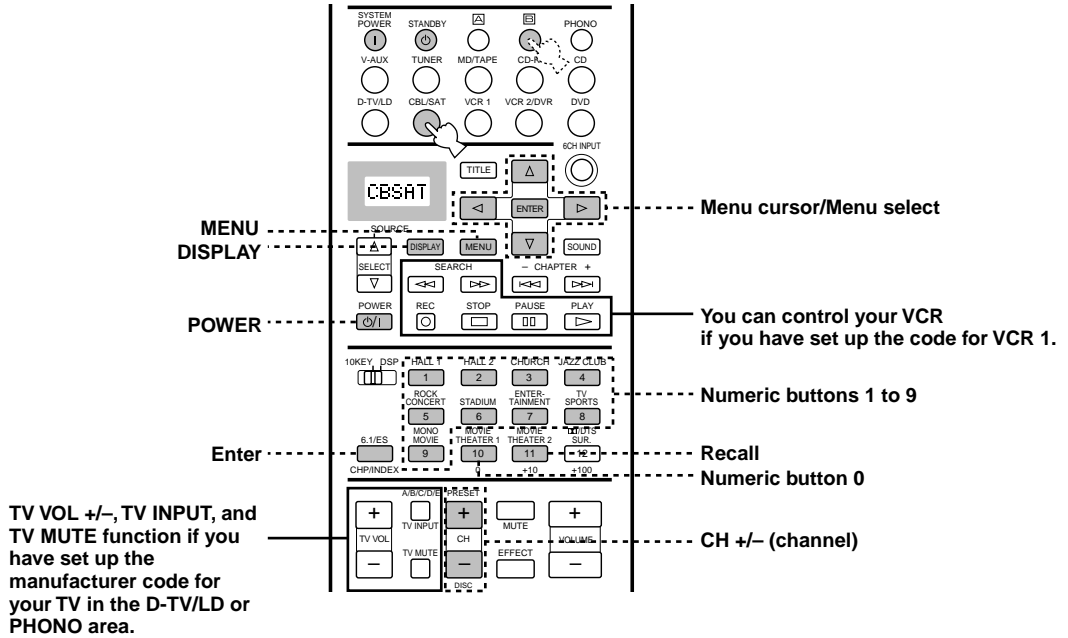

### Notes

- The B button is not the input selector and only switches the component area for operating a satellite tuner.
- When the manufacturer code for your TV is set up in the both D-TV/LD and PHONO areas, priority is given to the signal in the D-TV/LD area.

## ■ Free area (OPTN area)

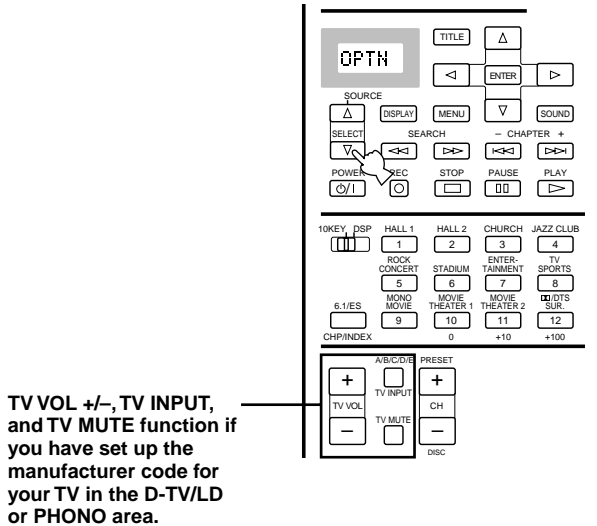

### Note

- When the manufacturer code for your TV is set up in the both D-TV/LD and PHONO areas, priority is given to the signal in the D-TV/LD area.

## Setting the Manufacturer Code

You can control other components by setting a manufacturer code. A code can be set up in each component control area except for the OPTN area.

The YAMAHA code is factory set for A, TUNER, CD, MD/TAPE, CD-R and DVD. There is no factory-set code for B, PHONO, V-AUX, D-TV/LD, CBL/SAT, VCR 1 and VCR 2/DVR.

- 1 Press an input selector button, A or B to select the source component you want to set up.**

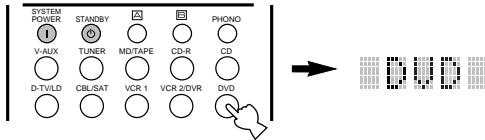

- 2 Press and hold LEARN for about 3 seconds by using a ballpoint pen or similar object. "SETUP" and the selected component name appear alternately in the display window.**

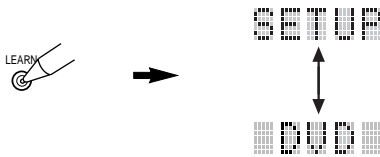

### Notes

- Press LEARN for at least 3 seconds, otherwise the learning process is started.
- If you do not press any button within 30 seconds during step 3, the setup process is canceled. If this happens, start over from step 2.

- 3 Press  $\Delta$  /  $\nabla$  to select the name of your component's manufacturer.**

You will find the names of most worldwide audio-video manufacturers in alphabetical order in the display window.

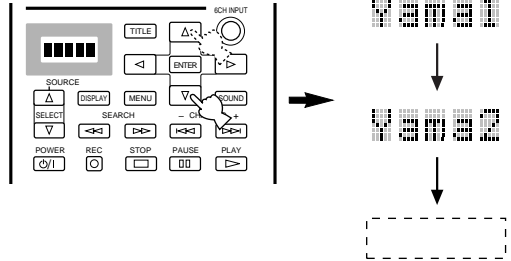

- 4 Press POWER (or any other button) to check if you have set up the code correctly.**

If the component cannot be controlled with the remote control, try setting another code for the same manufacturer.



- If you continuously want to set up another code for another component, press ENTER and repeat steps 1, 3 and 4.

- 5 Press LEARN again to exit from the setup mode.**



### Notes

- If you have already programmed a remote control function for a button, the function by learning or macro programming takes priority over the setup manufacturer code's function.
- "ERROR" appears in the display window under the following circumstances:
  - when pressing a button other than the cursor and ENTER;
  - when pressing more than one button at once; or
  - when MACRO ON/OFF, 10KEY/DSP or PARAMETER/SET MENU is switched to another position.

**Controlling a different component from the source component (input) you have selected**

**1** Repeat steps 1 and 2 of the procedure in “Setting the Manufacturer Code”.

**2** Press **</>** to select a library (component category).

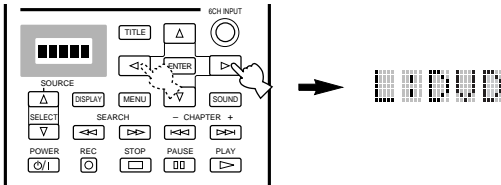

There are 13 libraries to set up a manufacturer code: L:TV, L:CAB (CABLE), L:DBS, L:SAT, L:VCR, L:DVD, L:LD, L:CD, L:CDR, L:MD, L:TAP (TAPE), L:TUN (TUNER) and \*L:AMP.

**3** Repeat steps 3 and 4 of the procedure in “Setting the Manufacturer Code”.

**About amplifier libraries (L:AMP)**

L:AMP has 4 codes: YPC, Zone2, DSP, and No. “YPC” or “Zone2” should be selected to operate this unit. “DSP” is for operating YAMAHA DSP amplifiers other than this unit. “No” is to clear this unit control area functions.

**Note**

- “YPC” is factory-set as the amplifier library. When you make up a second audio-video room with this unit’s Zone 2 feature, you must set “Zone2” as the amplifier library in the remote control (see page 62 for details).

**Programming a New Remote Control Function (Learn Feature)**

If you want to program functions not included in the basic operations covered by the manufacturer code, or a manufacturer code is not available, the following procedure needs to be performed. The possible programming area is the same as a component control area, so the buttons are programmable independently for each source component area.

**Note**

- This remote control transmits infrared rays. If the other remote control also uses infrared rays, this remote control can learn most of the other remote control’s functions. However, you may not be able to program some special signals or extremely long transmissions. (Refer to the operation instructions for the other remote control.)

**1** Set **10KEY/DSP** to **10KEY**.



**2** Press an input selector button, **A** or **B** to select a source component.

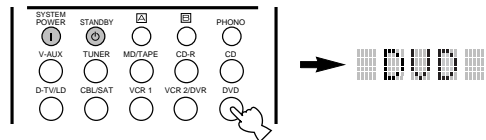

**3** Place this remote control and the other remote control about 50 to 100 mm (2 to 4 in.) apart on a flat surface so that their infrared transmitters are aimed at each other.

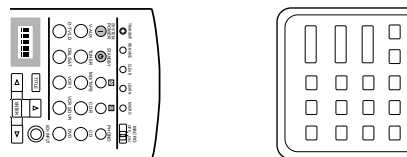

about 50 to 100 mm  
(2 to 4 in.)

**4 Press LEARN by using a ballpoint pen or similar object.**

“LEARN” and the selected component name appear alternately in the display window.

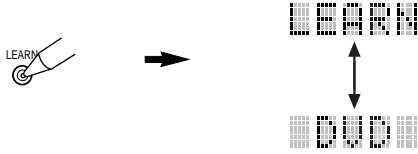

**Note**

- If you do not press any button within 30 seconds during steps 5 and 6, the learning process is canceled. If this happens, start over from step 4.

**5 Press the button for which you want to program the new function.**

“LEARN” is displayed.

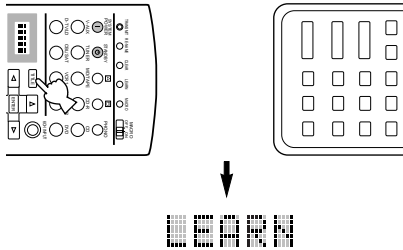

**6 Press and hold the button on the other remote control that has the function you want to program into this remote control until “OK” appears in the display window.**

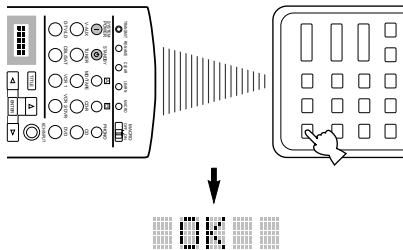

**Notes**

- “NG” appears in the display window when programming has not been done correctly. In this case, start over from step 5.
- When the memory is full, “FULL” appears in the display window, and this remote control cannot acquire any more functions. Clear unnecessary programmed functions to allow this remote control to acquire new functions.

**7 Repeat steps 5 and 6 to program additional functions.**

**8 Press LEARN again to exit from the learning mode.**

















**Notes**

- It is also possible to program in the control area of this unit with 10KEY/DSP set to DSP. However, if you program functions in this area, you cannot control this unit and select a DSP program.
- Even if the batteries in the other remote control have enough power to transmit signals for operation, they may not have enough power to transmit signals to this remote control.
- When the remote controls are either too close together or too far apart, you may not be able to program this remote control.
- Direct sunlight interferes with infrared rays.
- “ERROR” appears in the display window in the following circumstances:
  - when pressing more than one button at once; or
  - when MACRO ON/OFF is switched to another position.

## Using the Macro Feature

The Macro feature makes it possible to perform a series of operations by pressing just one button. For example, when you want to play a CD, normally you would turn on the components, select the CD input, and press the play button to start playback. The Macro feature lets you perform all those operations by simply pressing the CD macro button. The macro buttons (the input selector buttons, A and B buttons, SYSTEM POWER and STANDBY) are factory set with macro programs. You can also program your own macros (see page 58).

Press one of the macro buttons		Automatically transmits signals of each button sequentially		
		   (CD area)		
Macro buttons		First	Second	Third
PHONO			PHONO	—
V-AUX			V-AUX	—
TUNER			TUNER (*4)	—
MD/TAPE			MD/TAPE	 (MD/TAPE area) (*3)
CD-R			CD-R	 (CD-R area) (*3)
CD			CD	 (CD area) (*3)
D-TV/LD			D-TV/LD	—
CBL/SAT		 (*1)	CBL/SAT	—
VCR 1			VCR 1	 (VCR 1 area) (*3)
VCR 2/DVR			VCR 2/DVR	 (VCR 2/DVR area) (*3)
DVD			DVD	 (DVD area) (*3)
			—	—
			—	—
SYSTEM POWER			POWER 	—
			(D-TV/LD area) (*2)	
STANDBY		STANDBY 	—	—

- \*1 In order to turn on some components (including YAMAHA components) connected to this unit, connect those components to the AC OUTLET(S) on the rear panel. (Power control may not be synchronized with this unit depending on the component. For details, please refer to the operation instruction for the connected component.)
- \*2 If the macro you select includes power control functions, the component may be turned off if it is already on when you press the macro button. For example, if your TV is on and you press the SYSTEM POWER macro button, the TV is turned off.
- \*3 Playback can be started with any YAMAHA remote control-compatible MD recorders, CD players, CD recorders, DVD players, and LD players. When using macros to operate other components, it is either necessary to program the PLAY button on the control area of that component (see page 55) or to set up a manufacturer code (see page 54).
- \*4 When TUNER is selected as the input source, this unit receives the last station when this unit is set in the standby mode.

## ■ Operating the macro

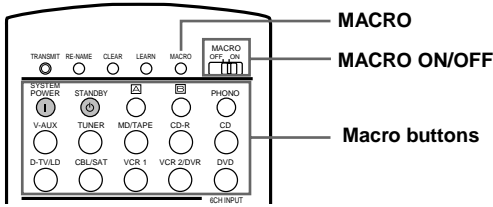

**1** Set MACRO ON/OFF to ON.

**2** Press a macro button.

### Notes

- When you have finished using the Macro feature, set MACRO ON/OFF to OFF.
- While this unit is carrying out a macro program, the unit does not receive any other button's function until the macro operation has been completed (the TRANSMIT indicator stops flashing).
- Continue to aim the remote control at the component the macro is operating until the macro operation has been completed.

## ■ Programming a macro

You can program your own macros and use the Macro feature to transmit many remote control commands by pressing a single button.

### Notes

- The factory-set macro is not cleared when a new macro is programmed for a button. The factory-set macro can be used again when the programmed macro is cleared.
- It is not possible to add a new signal (macro step) to the factory-set macro. Programming a macro changes all macro contents.
- A macro programming is used to transmit learning or setup (or YAMAHA preset) button signals of this remote control to a macro button. If necessary, set up the manufacturer code or program a function with the remote control for your component.
- This remote control handles button signals that operate continuously, such as volume control, as short time interval codes. Macro programming that include these types of macro steps are therefore not recommended.

**1** Press MACRO by using a ballpoint pen or similar object.

“MCR ?” appears in the display window.



### Note

- If you do not press any button within 30 seconds during steps 2 and 3, the macro programming process is canceled. If this happens, start over from step 1.

**2** Press a macro button for which you want to program the macro operation.

The button you chose for programming the macro operation and the selected component name appear alternately in the display window.

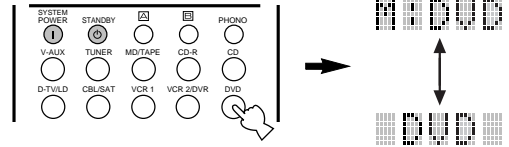

### Note

- “AGAIN” appears in the display window when a button other than the macro buttons is pressed.



- If you want to change the source component, use SOURCE SELECT  $\Delta$  /  $\nabla$  or input selector buttons. When you use the input selector buttons, selecting the input is programmed as a macro step, whereas SOURCE SELECT  $\Delta$  /  $\nabla$  only changes the component.

**3** Press the buttons of the functions that you want to include in the macro operation sequence in order.



- You can set up to 10 steps (10 functions). After you have set 10 steps, “FULL” appears and the remote control automatically exits from the macro mode.

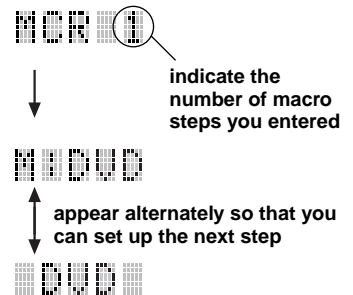
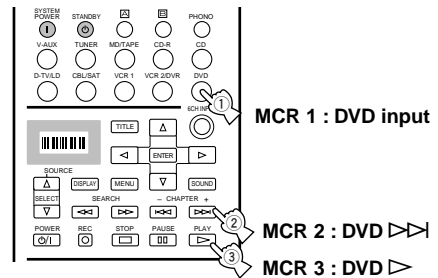

### Note

- “NG” appears in the display window when programming has not been done correctly. In this case, start over from step 2.

**4** Press **MACRO** again when the operation sequence you want to program is complete.



**Note**

- “ERROR” appears in the display window under the following circumstances:
  - when pressing more than one button at once; or
  - when MACRO ON/OFF is switched to another position.

**Memory back-up**

If the remote control is without batteries for more than 3 minutes, or if exhausted batteries remain in the remote control, the contents of the memory may be cleared. When the memory is cleared, insert new batteries, set up the manufacturer code and program any acquired functions that may have been cleared.

**4** Press **◀/▶** to move the cursor to the next position.

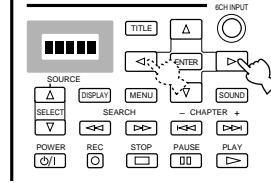

- If you continuously want to rename another source component, press **ENTER** and repeat steps 1, 3 and 4.

**5** Press **RE-NAME** again to exit from the renaming mode.



**Changing the Source Name in the Display Window**

**1** Press an input selector button, **A** or **B** to select the source component you want to rename.

The selected component name appears in the display window.

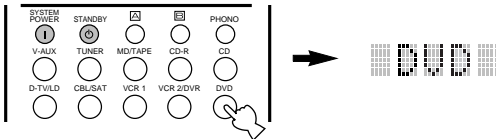

**2** Press **RE-NAME** by using a ballpoint pen or similar object.



**3** Press **Δ / ▽** to select and enter a character. Pressing **▽** changes the character in the following order: A to Z, a to z, 0 to 9, space, - (hyphen). (Pressing **Δ** goes in the reverse order.)

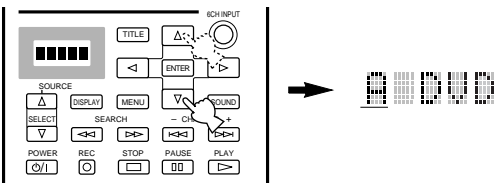

**Clearing a Learned Function or Macro**

**1** Press an input selector button, **A** or **B** to select the source component for which you want to clear the function.

The selected component name appears in the display window.

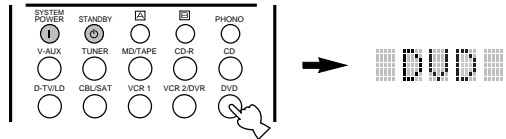

**2** Press **LEARN** if you want to clear a learned function, or press **MACRO** to clear a programmed macro by using a ballpoint pen or similar object.

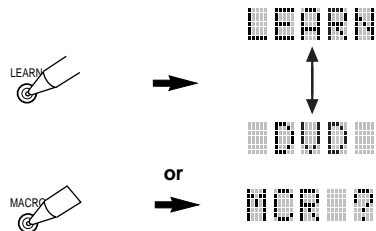

**Note**

- If you do not press any button within 30 seconds during step 3, the clearing process is canceled. If this happens, start over from step 2.

- 3** Press and hold CLEAR by using a ballpoint pen or similar object, and at the same time press the button for which you want to clear the learned function or macro for about 3 seconds.

“C:OK” appears in the display window.

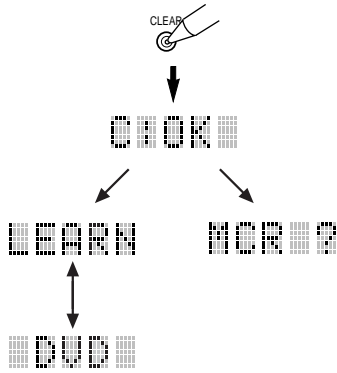

- You can clear other learned functions and macros at this time by holding down CLEAR again and pressing the other buttons for which those learned functions or macros have been programmed.

**Note**

- “C:NG” appears in the display window if the operation is unsuccessful. In this case, try step 3 again.

- 4** Press LEARN or MACRO again to exit from the clearing mode.

Once you have cleared a learned function or macro for a button, the button reverts to the factory setting.

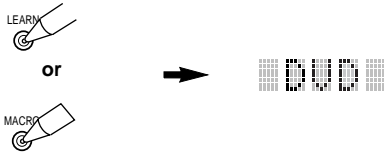

**Clearing Learned Functions, Macros, Renamed Source Names, and Setup Manufacturer Codes**

- 1** Press CLEAR by using a ballpoint pen or similar object.



**Note**

- If you do not press any button within 30 seconds during steps 2 and 3, the clearing process is canceled. If this happen, start over from step 1.

- 2** Press  $\Delta$  /  $\nabla$  to select the clear mode.

The mode is shown in the display window in the following order:

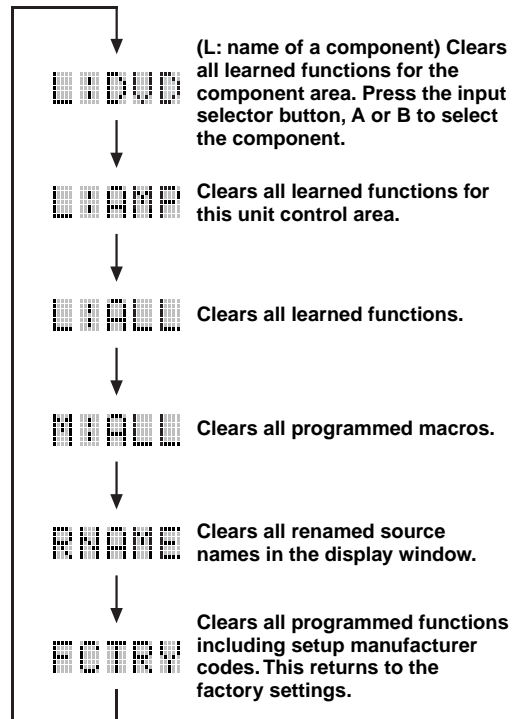

- 3** Press and hold CLEAR again for about 3 seconds.

“C:OK” appears in the display window.

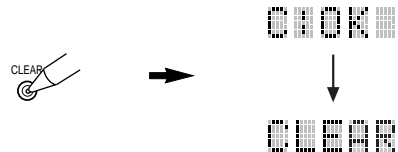

**Note**

- “C:NG” appears in the display window if the operation is unsuccessful. In this case, start over from step 2.

- 4** Press CLEAR to exit from the clearing mode.

Once you have cleared a learned function or macro for a button, the button reverts to the factory setting.



**Note**

- “ERROR” appears in the display window under the following circumstances:
  - when pressing a button other than the cursor and ENTER;
  - when pressing more than one button at once; or
  - when MACRO ON/OFF, 10KEY/DSP or PARAMETER/SET MENU is switched to another position.



## ZONE 2

You can make up a multi-room audio-video system with this unit. This feature enables you to set this unit to reproduce separate input sources in the main room and second room (Zone 2) with the supplied remote control in the second room.

Only analog signals are sent to the second room. For any source you want to listen to in the second room, you must connect the analog output jack from the source to the corresponding analog input jack on this unit.

### Zone 2 Connections

To use the multi-room functions of this unit, you need the following additional equipment:

- An infrared signal receiver in the second room
- An infrared emitter in the main room  
This emitter transmits the infrared signals from the remote control in the second room to the main room (for example, to a CD player or LD player).
- An amplifier and speakers for the second room
- A video monitor for the second room



- Since there are so many ways to connect and use this unit in a multi-room installation, we recommend that you consult with the nearest authorized YAMAHA dealer or service center for the Zone 2 connections which will best meet your requirements.
- Some YAMAHA models are able to connect directly to the REMOTE CONTROL OUT jack of this unit. If you own these products, you may not need to use an infrared emitter. Up to 6 YAMAHA components can be connected as shown.

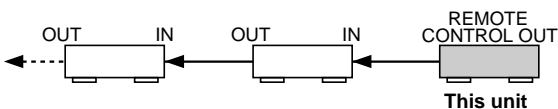

### ■ Example of a system configuration and connections

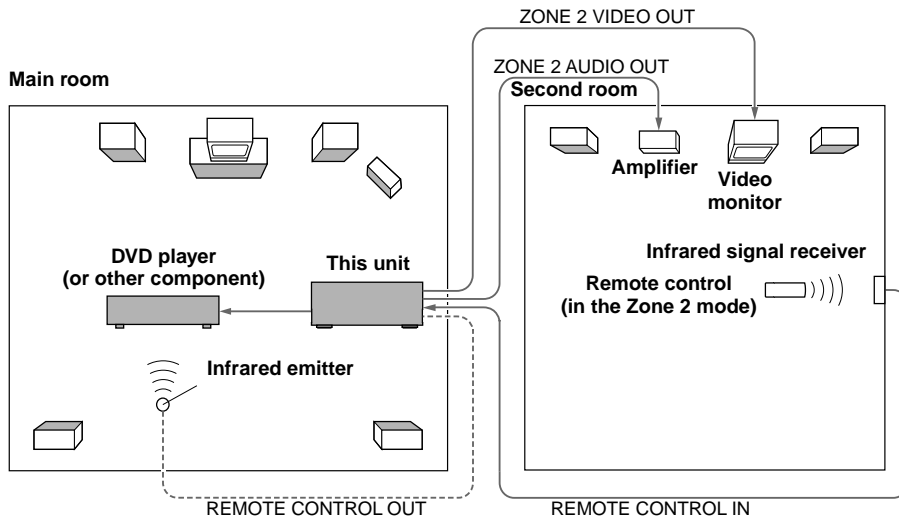

## Special considerations when using DTS software

The DTS signal is a digital bitstream. Therefore, if you attempt to send the DTS signal to the second room, you will only be able to hear the digital noise sound that could damage your speakers.

Due to this characteristic of DTS encoded discs, the following considerations and adjustments need to be made.

### For LDs or DVDs encoded with DTS

Only 2-channel analog audio signals may be sent to the second room, as follows:

- LDs  
Set your LD player's left and right outputs to the analog soundtrack.
- DVDs  
Use the disc menu to set the DVD player's mixed 2-channel left and right audio outputs to the PCM or Dolby Digital soundtrack.

### For CDs encoded with DTS

DO NOT USE the Zone 2 feature for CDs encoded with DTS.

## Remote Control in Zone 2

In the second room (Zone 2), the supplied remote control can be used for the Zone 2 remote control. You can select the input source and control the component which is located in the main room directly from the second room regardless of the listening condition in the main room.

Before starting the following procedure, set REC OUT/ZONE 2 on the front panel to SOURCE/REMOTE.

**1** Repeat steps 1 and 2 of the procedure in "Setting the Manufacturer Code" on page 54.

**2** Press  $\triangleleft$  /  $\triangleright$  to select "L:AMP".

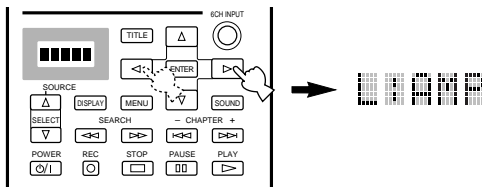

**3** Press  $\triangle$  /  $\nabla$  to select "Zone2".

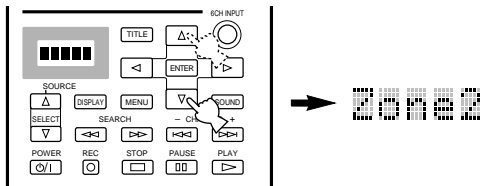

**4** Press LEARN to complete the Zone 2 setup.



**5** Press SOURCE SELECT  $\triangle$  to display "Zone2" in the display window.

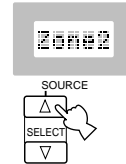

**6** Press an input selector button to select the input source you want to listen to in the second room.

The display window shows "2: name of selected input" if the remote control is in the Zone 2 mode.

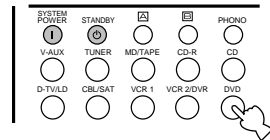

**7** You can control the component by using the component control area buttons.

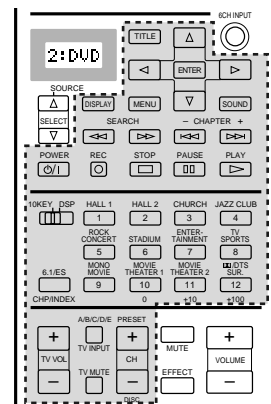

### Note

- Adjust the Zone 2 volume with the control on the amplifier in the second room.

**8** Press SOURCE SELECT  $\triangle$  /  $\nabla$  to exit from the Zone 2 mode.

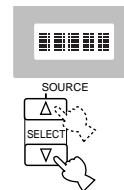

# SOUND FIELD PROGRAM

This unit incorporates a sophisticated, multi-program digital sound field processor (DSP). This processor allows you to electronically expand and change the shape of the audio sound field from both audio and video sources, creating a theater-like experience in your listening room. You can create outstanding audio sound field by selecting a suitable DSP program (this will, of course, depend on what you are listening to) and making desired adjustments.

The following list gives you a brief description of the sound fields produced by each of the DSP programs. Keep in mind that most of these are precise digital recreations of actual acoustic environments.

## Note

- Select the DSP program that you feel sounds best regardless of the name and description given for it below.

## Hi-Fi DSP Programs

### ■ For audio sources: Nos. 1 to 7

No.	Program (group)	Sub-program	Features
1	CONCERT HALL 1	—	This is a large fan-shaped concert hall which has approximately 2500 seats. Almost the whole interior is made of wood. There is relatively little reflection from the walls, and sound spreads finely and beautifully.
2	CONCERT HALL 2	—	A large round concert hall with a rich surround effect. Pronounced reflections from all directions emphasize the extension of sounds. The sound field has a great deal of presence, and your virtual seat is near the center, close to the stage.
3	CHURCH	—	This program recreates the acoustic environment of a big church with a high dome and columns along each side. The reverberation delay is very long while the early reflections are smaller than with other sound field programs.
4	JAZZ CLUB	—	This is the sound field at stage front in “The Bottom Line”, a famous New York jazz club. The floor can seat 300 people to the left and right in a sound field offering a real and vibrant sound.
5	ROCK CONCERT	—	The ideal program for lively, dynamic rock music. The data for this program was recorded at LA’s “hottest” rock club. The listener’s virtual seat is at the center-left of the hall.
6	STADIUM	—	This program gives you the long delays and extraordinarily spacious feel of an outdoor stadium in Los Angeles that is no less than 300 meters (990 feet) in diameter.
7	ENTERTAINMENT	Disco	This program recreates the acoustic environment of a lively disco in the heart of a big city. The sound is dense and highly concentrated. It is also characterized by a high-energy, “immediate” sound.
		6ch Stereo	Using this program increases the listening position range. This is a sound field suitable for background music at parties.

## Note

- If “1A CENTER SP” on the SET MENU is set to NONE, no sound is output from the center speaker.

## CINEMA DSP Programs

### ■ For audio-video sources: Nos. 7 to 9

No.	Program (group)	Sub-program	Features
7	ENTERTAINMENT	Game	This program adds a deep and spatial feeling to video game sounds.
8	TV SPORTS	—	Although the presence sound field is relatively narrow, the surround sound field employs the sound environment of a large concert hall. With this program, you can enjoy watching various TV programs such as news, variety shows, music programs or sports programs. In a stereo broadcast of a sports game, the commentator is oriented at the center position, and the shouts and the atmosphere in the stadium spread on the surround side, while their spread to the rear is properly restrained.
9	MONO MOVIE	—	This program is provided for reproducing monaural video sources (such as old movies). The program produces the optimum reverberation to create sound depth by using only the presence sound field.

### ■ For movie programs: Nos. 10 to 12

No.	Program (group)	Sub-program		Input source	Features	
10	MOVIE THEATER 1	Spectacle	70 mm Spectacle	Analog, PCM, Dolby Digital in 2-channel	This program creates the extremely wide sound field of a 70-mm movie theater. It precisely reproduces the source sound in detail, making both the video and the sound field incredibly real. This is ideal for any kind of video source encoded with Dolby Surround, Dolby Digital or DTS (especially large-scale movie productions).	
			DGTL Spectacle *1	Dolby Digital		
			Spectacle 6.1 *2			
			DTS Spectacle *1	DTS		
			Spectacle ES *2			
		Sci-Fi	70 mm Sci-Fi	Analog, PCM, Dolby Digital in 2-channel		This program clearly reproduces dialog and sound effects in the latest sound form of science fiction films, thus creating a broad and expansive cinematic space amid the silence. You can enjoy science fiction films in a virtual-space sound field that includes Dolby Surround, Dolby Digital and DTS-encoded software employing the most advanced techniques.
			DGTL Sci-Fi *1	Dolby Digital		
			Sci-Fi 6.1 *2			
			DTS Sci-Fi *1	DTS		
			Sci-Fi ES *2			

No.	Program (group)	Sub-program		Input source	Features	
11	MOVIE THEATER 2	Adventure	<b>70 mm Adventure</b>	Analog, PCM, Dolby Digital in 2-channel	This program is ideal for precisely reproducing the sound design of the newest 70-mm and multichannel soundtrack films. The sound field is made to be similar to that of the newest movie theaters, so the reverberations of the sound field itself are restrained as much as possible.	
			<b>DGTL Adventure *1</b>	Dolby Digital		
			<b>Adventure 6.1 *2</b>			
			<b>DTS Adventure *1</b>	DTS		
			<b>Adventure ES *2</b>			
		General	<b>70 mm General</b>	Analog, PCM, Dolby Digital in 2-channel		This program is for reproducing sounds from 70-mm and multichannel soundtrack films, and is characterized by a soft and extensive sound field. The presence sound field is relatively narrow. It spatially spreads all around and toward the screen, restraining the echo effect of conversations without losing clarity. For the surround sound field, the harmony of music or chorus sounds beautifully in a wide space at the rear of the sound field.
			<b>DGTL General *1</b>	Dolby Digital		
			<b>General 6.1 *2</b>			
			<b>DTS General *1</b>	DTS		
			<b>General ES *2</b>			

No.	Program (group)	Sub-program		Input source	Features
12	Dolby/DTS SURROUND	Normal/ Matrix 6.1/ES	PRO LOGIC/Normal	Analog, PCM, Dolby Digital in 2-channel	The built-in decoder precisely reproduces sounds and sound effects from sources. The highly efficient decoding process improves crosstalk and channel separation, and makes sound positioning smoother and more precise. In this program, the digital sound field processor is not turned on.
			DOLBY DIGITAL/Normal *1	Dolby Digital	
			DOLBY DIGITAL/Matrix 6.1 *2		
			DTS DIGITAL SUR./Normal *1	DTS	
			DTS DIGITAL SUR./ES *2		
		Enhanced	PRO LOGIC/Enhanced	Analog, PCM, Dolby Digital in 2-channel	This program ideally simulates the multi-surround speaker systems of the 35-mm film theaters. Dolby Pro Logic decoding, Dolby Digital decoding or DTS decoding and digital sound field processing create precise effects without altering the original sound orientation. The surround effects produced by this sound field wrap around the viewer naturally from the back to the left and right, and toward the screen.
			DOLBY DIGITAL/Enhanced *1	Dolby Digital	
			DOLBY DIGITAL/Enhanced 6.1 *2		
			DTS DIGITAL SUR./Enhanced *1	DTS	
			DTS DIGITAL SUR./Enhanced ES *2		

\*1 The Dolby Digital Matrix 6.1 or DTS ES decoder is off.

\*2 The Dolby Digital Matrix 6.1 or DTS ES decoder is on. The “” indicator lights up on the front panel display.



- If a Dolby Digital signal or DTS signal is input when the input mode is set to AUTO, the DSP program will be automatically switched to the Dolby Digital playback sound field or DTS playback sound field.
- If Dolby Digital Surround EX software or DTS ES software is played when “12 6.1/ES AUTO” on the SET MENU is set to ON, the Dolby Digital Matrix 6.1 or DTS ES decoder will automatically turn on and the corresponding DSP program will be selected.
- 6.1/ES on the remote control can be used to turn the Dolby Digital Matrix 6.1 or DTS ES decoder on or off during Dolby Digital 5.1-channel source or DTS 5.1-channel source playback.

**Notes**

- The “” indicator does not light up when selecting the sub-program “Normal” of the Dolby/DTS SURROUND program.
- If “1A CENTER SP” on the SET MENU is set to NONE, no sound is output from the center speaker.
- The effect sound is output from the main speakers when a monaural source is played with CINEMA DSP program groups 7 (Game) and 8 to 11.

## MOVIE THEATER Programs

Most movie software has 4-channel (left, center, right and surround) sound information encoded by Dolby Surround matrix processing and stored on the left and right tracks. These signals are processed by the Dolby Pro Logic decoder. The MOVIE THEATER programs are designed to recreate the spaciousness and delicate nuances of sound that tend to be lost in the encoding and decoding processes.

The 6-channel soundtracks found on 70-mm film produce precise sound field localization and rich, deep sound without using matrix processing. This unit's MOVIE THEATER 70-mm programs provide the same quality of sound and sound localization that 6-channel soundtracks do. The built-in Dolby Digital or DTS decoder brings the professional-quality sound designed for movie theaters into your home. With the unit's MOVIE THEATER programs, you can recreate a dynamic sound that gives you the feeling of being at a public theater in your listening room by using Dolby Digital or DTS technology.

### ■ Dolby Pro Logic + DSP sound field effect

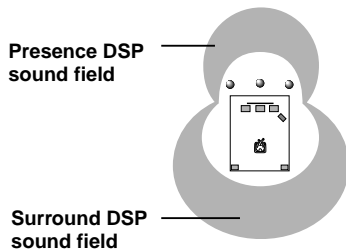

These programs express an immense sound field and a large surround effect. They also give depth to the sound from the main speakers to recreate the realistic sound of a Dolby Stereo theater.

### ■ Dolby Digital/DTS + DSP sound field effect

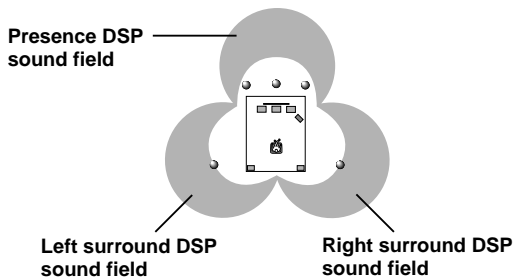

These programs use YAMAHA's tri-field DSP processing on each of the Dolby Digital or DTS signals for the front, left surround and right surround channels. This processing enables the this unit to reproduce the immense sound field and surround expression of a Dolby Digital- or DTS-equipped movie theater without sacrificing the clear separation of all channels.

### ■ Dolby Digital Matrix 6.1/DTS ES + DSP sound field effect

These programs provide you with the maximum experience of the spacious surround effects since an extra rear center DSP sound field created from the rear center channel is added.

# SOUND FIELD PROGRAM PARAMETER EDITING

## *What is a sound field?*

What really creates the rich, full tones of a live instrument are the multiple reflections from the walls of the room. In addition to making the sound “live”, these reflections enable us to tell where the player is situated, and the size and shape of the room in which we are sitting.

### ■ Elements of a sound field

In any environment, in addition to the direct sound coming straight to our ears from the player’s instrument, there are two distinct types of sound reflections that combine to make up the sound field:

#### **Early reflections**

Reflected sounds reach our ears extremely rapidly (50 ms – 100 ms after the direct sound), after reflecting from one surface only — for example, from the ceiling or a wall. These reflections fall into specific patterns as shown in the diagram on page 70 for any particular environment, and provide vital information to our ears. Early reflections actually add clarity to the direct sound.

#### **Reverberations**

These are caused by reflections from more than one surface — walls, ceiling, the back of the room — so numerous that they merge together to form a continuous sonic “afterglow”. They are non-directional, and lessen the clarity of the direct sound.

Direct sound, early reflections and subsequent reverberation taken together help us to determine the subjective size and shape of the room, and it is this information that the digital sound field processor reproduces in order to create sound fields.

If you could create the appropriate early reflections and subsequent reverberations in your listening room, you would be able to create your own listening environment. The acoustics in your room could be changed to those of a concert hall, a dance floor, or virtually any size room at all. This ability to create sound fields at will is exactly what YAMAHA has done with the digital sound field processor.

## *Sound Field Program Parameters*

DSP programs consist of some parameters to determine the apparent room size, reverberation time, distance from you to the performer, etc. In each program, these parameters are set with values precisely calculated by YAMAHA to create a sound field unique to the program. It is recommended to use DSP programs without changing the values of parameters; however, this unit also allows you to create your own sound fields. Starting with one of the built-in programs, you can adjust those parameters.

Each DSP program has a set of parameters that allow you to change the characteristics of the acoustic environment to precisely create the effect you want. These parameters correspond to the many natural acoustic factors that create the sound field you experience in an actual concert hall or other listening environment. The size of the room, for example, affects the length of time between the early reflections. The “ROOM SIZE” parameter provided in many of the DSP programs alters the timing between these reflections, thus changing the shape of the “room” you are listening. In addition to room size, the shape of the room and the characteristics of its surfaces have a significant effect on the final sound. Surfaces that absorb sound, for example, cause the reflections and reverberations to die out more quickly, while highly reflective surfaces allow the reflections to carry on for a longer period of time. The digital sound field parameters allow you to control these and many other factors that contribute to your personal sound field, allowing you to essentially “redesign” the concert halls, theaters, etc. provided to create custom-tailored listening environments that ideally match your mood and music.

See “Digital Sound Field Parameter Descriptions” on pages 70 to 73.



## Changing Parameter Settings

You can enjoy good quality sound with the factory-set parameters. Although you do not have to change the initial settings, you can change some of the parameters to better suit the input source or your listening room.

Adjustments should be made with the remote control.



- We recommended that you edit the parameter while using a video monitor. It is easier to see the video monitor than it is to see the front panel display.

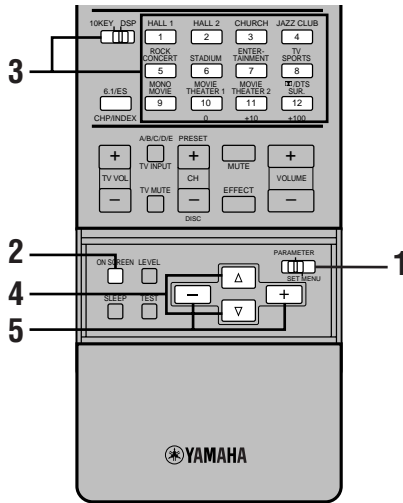

- 1 Set **PARAMETER/SET MENU** to **PARAMETER**.



- 2 Turn on the video monitor and press **ON SCREEN** repeatedly to select the full display mode.



- 3 Select a **DSP program** you want to adjust.

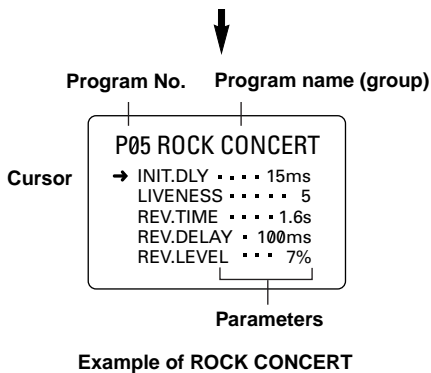
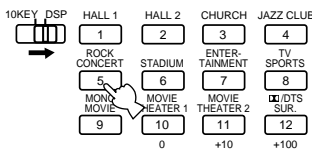

- 4 Press  $\Delta$  /  $\nabla$  to select the parameter.

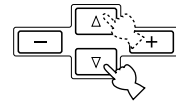

- 5 Press **-/+** to change the parameter value.

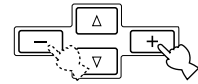

- When you set the parameter to a value other than the factory-set value, an asterisk mark (\*) appears by the parameter name on the video monitor.

- 6 Repeat steps 3 to 5 above as necessary to change other program parameters.

### Memory back-up

The memory back-up circuit prevents the stored data from being lost even if this unit is set in the standby mode, the power cord is disconnected from the AC outlet, or the power supply is temporarily cut due to power failure. However, if the power is cut for more than one week, the parameter value you edited will return to the factory setting. If so, edit the parameter value again.

## Resetting a Parameter to the Factory-set Value

- To reset some of the parameters to the factory-set values

Select the parameter you want to reset. Then press and hold **-** or **+** until the value temporarily stops at the factory-set value. The asterisk mark (\*) by the parameter name disappears on the video monitor.

- To reset all of the parameters to the factory-set values

Use “9 PARAM. INI” on the SET MENU to reset all of the parameter values of all DSP programs within the selected group to the factory-set values (see page 42). This operation resets all of the parameter values of all DSP programs within that group to the factory-set values.

### Notes

- The available parameters may be displayed on more than one OSD page for some of the programs. To scroll through pages, press  $\Delta$  /  $\nabla$ .
- You cannot change parameter values when “15 MEMORY GUARD” on the SET MENU is set to ON. If you want to change the parameter values, set “15 MEMORY GUARD” to OFF (see page 44).

## Digital Sound Field Parameter Descriptions

You can adjust the values of certain digital sound field parameters so the sound fields are recreated accurately in your listening room.

**Note**

- Not all of the following parameters can be found in every program.

### INIT.DLY (initial delay) (P.INIT.DLY — for the presence sound field)

**Function:** This parameter changes the apparent distance from the sound source by adjusting the delay between the direct sound and the first reflection heard by the listener.

**Control range:** 1 – 99 msec

**Description:** The smaller the value, the closer the sound source seems to the listener. The larger the value, the farther the apparent distance seems. For a small room, this parameter would be set to a small value, for a large room, set it to a large value.

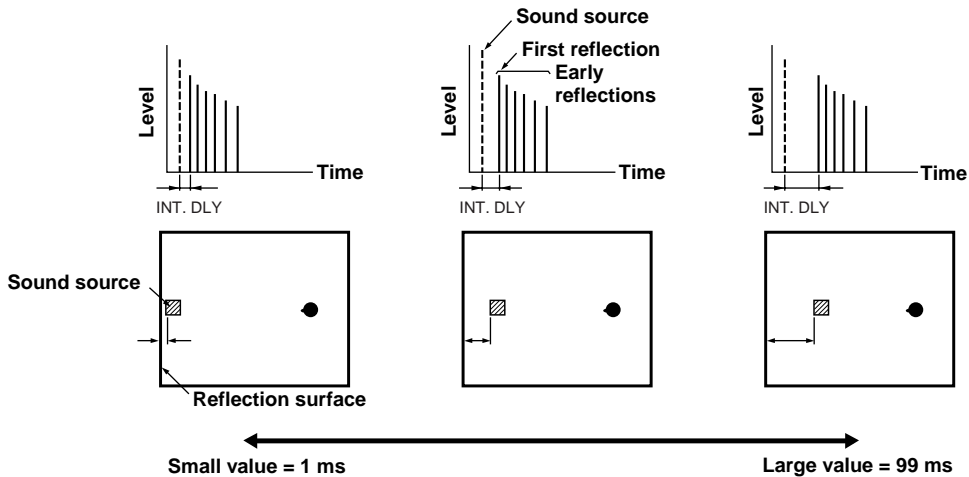

### ROOM SIZE (P.ROOM SIZE — for the presence sound field)

**Function:** This parameter adjusts the apparent size of the surround sound field. The larger the value, the larger the surround sound field becomes.

**Control range:** 0.1 – 2.0

**Description:** As the sound is repeatedly reflected around a room, the larger the hall is, the longer the time between the original reflected sound and the subsequent reflections. By controlling the time between the reflected sounds, you can change the apparent size of the virtual venue. Changing this parameter from one to two, doubles the apparent length of the room.

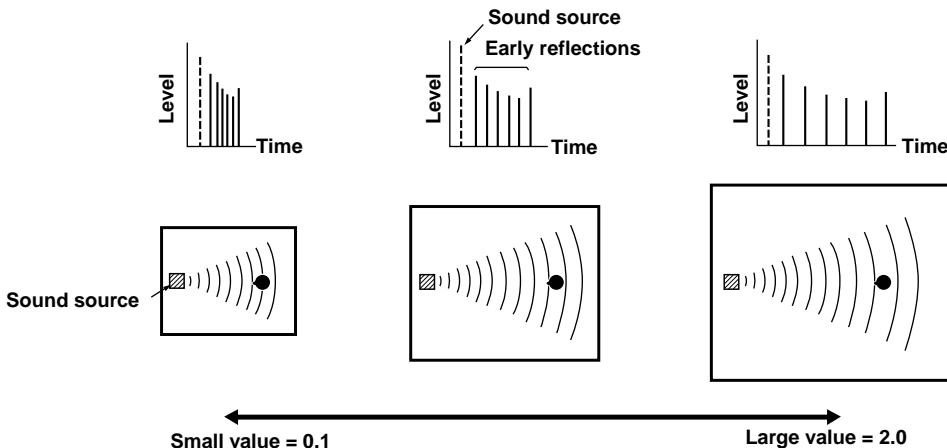

## ■ LIVENESS

**Function:** This parameter adjusts the reflectivity of the virtual walls in the hall by changing the rate at which the early reflections decay.

**Control range:** 0 – 10

**Description:** The early reflections of a sound source decay much faster in a room with acoustically absorbent wall surfaces than in one which has highly reflective surfaces. A room with acoustically absorbent surfaces is referred to as “dead,” while a room with highly reflective surfaces is referred to as “live.” The “LIVENESS” parameter lets you adjust the early reflection decay rate, and thus the “liveness” of the room.

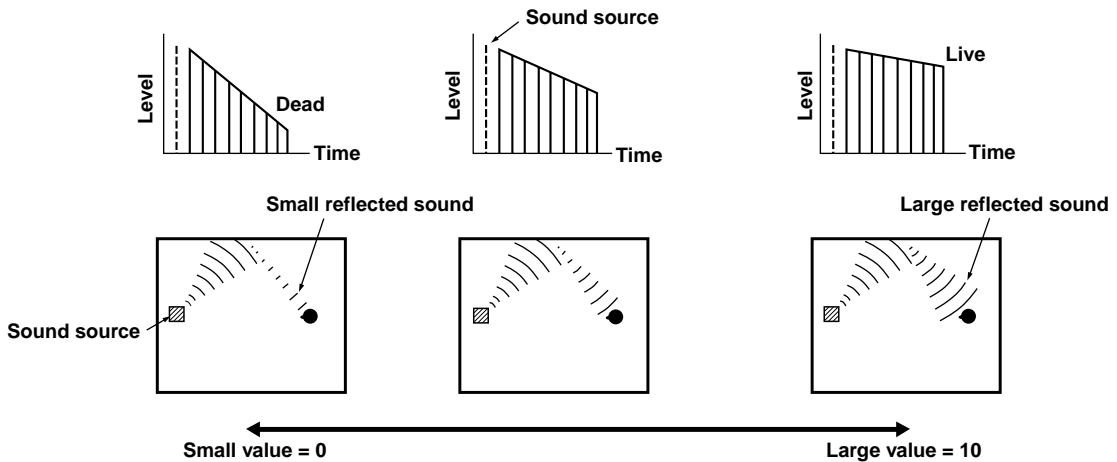

## ■ S.DELAY (surround delay)

**Function:** This parameter adjusts the delay between the direct sound and the first reflection in the surround sound field.

**Control range:** 0 – 49 msec (The range depends on the signal format.)

## ■ S.INIT.DLY (surround initial delay)

**Function:** This parameter adjusts the delay between the direct sound and the first reflection on the surround side of the sound field. You can only adjust this parameter when at least two front channels and two rear channels are used.

**Control range:** 1 – 49 msec

## ■ S.ROOM SIZE (surround room size)

**Function:** This parameter adjusts the apparent size of the surround sound field.

**Control range:** 0.1 – 2.0

## ■ S.LIVENESS (surround liveness)

**Function:** This parameter adjusts the apparent reflectivity of the virtual walls in the sound field.

**Control range:** 0 – 10

■ **RC.INIT.DLY (rear center initial delay)**

Function: This parameter adjusts the delay between the direct sound and the first reflection in the rear center sound field.

Control range: 1 – 49 msec

■ **RC.ROOM.SIZE (rear center room size)**

Function: This parameter adjusts the apparent size of the rear center sound field.

Control range: 0.1 – 2.0

■ **RC.LIVENESS (rear center liveness)**

Function: This parameter adjusts the apparent reflectivity of the virtual wall in the rear center sound field.

Control range: 0 – 10

■ **REV.TIME (reverberation time)**

Function: This parameter adjusts the amount of time it takes for the dense, subsequent reverberation sound to decay by 60 dB (at 1 kHz). This changes the apparent size of the acoustic environment over an extremely wide range.

Control range: 1.0 – 5.0 sec

Description: Set a longer reverberation time for “dead” sources and listening room environments and a shorter time for “live” sources and listening room environments.

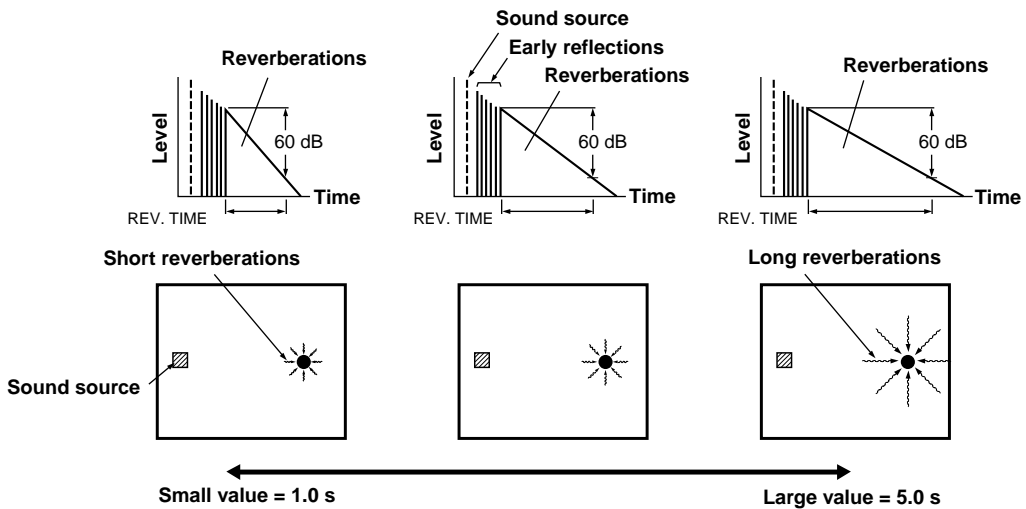

## ■ REV.DELAY (reverberation delay)

**Function:** This parameter adjusts the time difference between the beginning of the direct sound and the beginning of the reverberation sound.

**Control range:** 0 – 250 msec

**Description:** The larger the value, the later the reverberation sound begins. A later reverberation sound makes you feel like you are in a larger acoustic environment.

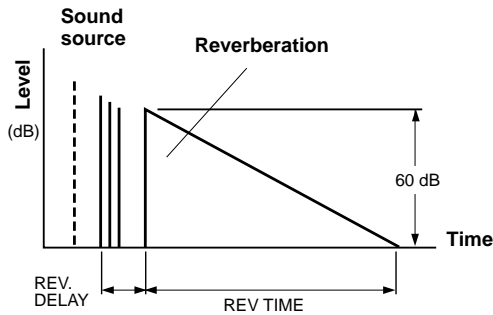

## ■ REV.LEVEL (reverberation level)

**Function:** This parameter adjusts the volume of the reverberation sound.

**Control range:** 0 – 100%

**Description:** The larger the value, the stronger the reverberation becomes.

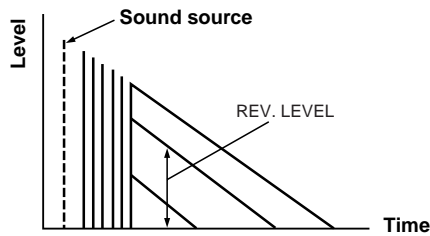

## ■ CT.DELAY (center delay)

## ■ LS.DELAY (left surround delay)

## ■ RC.DELAY (rear center delay)

## ■ RS.DELAY (right surround delay)

**Function:** These parameters adjust the sound delay for each channel in 6 channel stereo mode.

**Control range:** 0 – 50 msec

# TROUBLESHOOTING

Refer to the chart below when the unit does not function properly. If the problem you are experiencing is not listed below or if the instruction below does not help, set this unit in the standby mode, disconnect the power cord, and contact the nearest authorized YAMAHA dealer or service center.

## ■ General

Problem	Cause	Remedy	Refer to page
<b>The unit fails to turn on when STANDBY/ON (or SYSTEM POWER) is pressed, or enters in the standby mode soon after the power has been turned on.</b>	The power cord is not connected or the plug is not completely inserted.	Firmly connect the power cord.	19
	The IMPEDANCE SELECTOR switch on the rear panel is not fully set to the left or right position.	Set the switch fully to the left or right position when the unit is in the standby mode.	19
	The protection circuitry has been activated.	Make sure all speaker wire connections on this unit and on all speakers are secure and that the wire for each connection does not touch anything other than its respective connection.	16, 17
<b>No sound and/or no picture.</b>	Incorrect input or output cable connections.	Connect the cables properly. If the problem persists, the cables may be defective.	12 – 15
	An appropriate input source has not been selected.	Select an appropriate input source with INPUT <◀/▶> or 6CH INPUT (or the input selector buttons).	24
	The speaker connections are not secure.	Secure the connections.	16, 17
	The main speakers to be used have not been selected properly.	Select the main speakers with SPEAKERS A and/or B.	24
	The volume is turned down.	Turn up the volume.	25
	The sound is muted.	Press MUTE or any operation buttons of this unit to cancel a mute and adjust the volume.	25
	Digital signals other than PCM audio, Dolby Digital or DTS signal which this unit cannot reproduce are being input to this unit by playing a CD-ROM, etc.	Play a source whose signals this unit can reproduce.	—
<b>No picture.</b>	There is no S-video connection between this unit and the video monitor, although S-video signals are being input to this unit.	Connect the monitor's S-video input jack to this unit's S VIDEO MONITOR OUT jack.	14, 15
<b>The sound suddenly goes off.</b>	The protection circuit has been activated because of a short circuit, etc.	Check the IMPEDANCE SELECTOR switch is set to the appropriate position and then turn the unit back on.	19
		Check the speaker wires are not touching each other and then turn the unit back on.	16, 17
	The sleep timer has functioned.	Turn on the power, and play the source again.	46
	The sound is muted.	Press MUTE or any operation buttons of this unit to cancel a mute and adjust the volume.	25
<b>Only the speaker on one side can be heard.</b>	Incorrect cable connections.	Connect the cables properly. If the problem persists, the cables may be defective.	12 – 17
	Incorrect setting of "3 L/R BALANCE" on the SET MENU.	Adjust it to the appropriate position.	41

Problem	Cause	Remedy	Refer to page
<b>No sound from the effect speakers.</b>	The sound effect is off.	Press EFFECT to turn it on.	29
	A Dolby Surround, Dolby Digital or DTS decoding DSP program is being used with material not encoded with Dolby Surround, Dolby Digital or DTS.	Select another DSP program.	63 – 66
	A 96-kHz sampling digital signal is being input to this unit.		25
<b>No sound from the center speaker.</b>	The output level of the center speaker is set to minimum.	Raise the level of the center speaker.	45
	“1A CENTER SP” on the SET MENU is set to NONE.	Select the appropriate mode for your center speaker.	38
	One of the Hi-Fi DSP programs (1 to 7) has been selected.	Select another DSP program.	63 – 66
	The source encoded with a Dolby Digital or DTS signal does not have a center channel signal.		—
<b>No sound from the rear speakers.</b>	The output level of the rear speakers is set to minimum.	Raise the output level of the rear speakers.	45
	A monaural source is being played with the program 12.	Select another DSP program.	63 – 66
<b>No sound from the subwoofer.</b>	“1E LFE/BASS OUT” on the SET MENU is set to MAIN when a Dolby Digital or DTS signal is being played.	Select SWFR or BOTH.	39
	“1E LFE/BASS OUT” on the SET MENU is set to SWFR or MAIN when a 2-channel source is being played.	Select BOTH.	39
	The source does not contain low bass signals (90 Hz and below).		—
<b>Poor bass reproduction.</b>	“1E LFE/BASS OUT” on the SET MENU is set to SWFR or BOTH and your system does not include a subwoofer.	Select MAIN.	39
	The output mode for each speaker (main, center or rear) on the SET MENU does not match your speaker configuration.	Select the appropriate output mode for each speaker based on the size of the speakers in your configuration.	37 – 39
<b>No sound from the rear center speaker.</b>	“1D REAR CT SP” on the SET MENU is set to NONE.	Select LRG or SML.	39
<b>A “humming” sound can be heard.</b>	Incorrect cable connections.	Firmly connect the audio plugs. If the problem persists, the cables may be defective.	12 – 15
	No connection from the turntable to the GND terminal.	Connect the grounding cord of your turntable to the GND terminal of this unit.	12, 13
<b>The volume level is low while playing a record.</b>	The record is being played on a turntable with an MC cartridge.	The turntable should be connected to the unit through an MC-head amplifier.	12

<b>Problem</b>	<b>Cause</b>	<b>Remedy</b>	<b>Refer to page</b>
<b>The volume level cannot be increased, or the sound is distorted.</b>	The component connected to the REC OUT jacks of this unit is turned off.	Turn on the power to the component.	12
<b>The sound effect cannot be recorded.</b>	It is not possible to record the sound effect by a recording component.		35
<b>A source cannot be recorded by a digital recording component connected to the DIGITAL OUTPUT jack of this unit.</b>	A source component is only connected to the analog input jacks of this unit.	Connect the source component to the digital input jacks of this unit.	12 – 15
<b>The sound field parameters and some other settings on this unit cannot be changed.</b>	“15 MEMORY GUARD” on the SET MENU is set to ON.	Select OFF.	44
<b>This unit does not operate properly.</b>	The internal microcomputer has been frozen by an external electric shock (such as lightning or excessive static electricity) or by a power supply with low voltage.	Disconnect the AC power cord from the outlet and then plug it in again after about 30 seconds.	—
<b>“CHECK SP WIRES” appears on the front panel display.</b>	Speaker cables are short circuited.	Make sure all speaker cables are connected correctly.	16, 17
<b>The sound is degraded when listening with headphones connected to a tape deck or CD player that is connected to this unit.</b>	This unit is in the standby mode.	Turn on the power of the unit.	—
<b>There is noise interference from digital or high-frequency equipment, or the unit.</b>	The unit is too close to the digital or high-frequency equipment.	Move the unit further away from such equipment.	—



## ■ Tuner

	Problem	Cause	Remedy	Refer to page
FM	<b>FM stereo reception is noisy.</b>	The characteristics of FM stereo broadcasts may cause this problem when the transmitter is too far away or the antenna input is poor.	Check the antenna connections. Try using a high-quality directional FM antenna. Use the manual tuning method.	30, 31
	<b>There is distortion, and clear reception cannot be obtained even with a good FM antenna.</b>	There is multipath interference.	Adjust the antenna position to eliminate multipath interference.	30
	<b>The desired station cannot be tuned in with the automatic tuning method.</b>	The station is too weak.	Use the manual tuning method. Use a high-quality directional FM antenna.	30, 31
	<b>Previously preset stations can no longer be tuned in.</b>	The unit has been disconnected for a long period.	Re-store the stations.	32
AM	<b>The desired station cannot be tuned in with the automatic tuning method.</b>	The signal is weak or the antenna connections are loose.	Tighten the AM loop antenna connections and orient it for best reception. Use the manual tuning method.	30, 31
	<b>There are continuous crackling and hissing noises.</b>	Noises result from lightning, fluorescent lamps, motors, thermostats and other electrical equipment.	Use an outdoor antenna and a ground wire. This will help somewhat, but it is difficult to eliminate all noise.	30
	<b>There are buzzing and whining noises (especially in the evening).</b>	A TV set is being used nearby.	Move this unit away from the TV.	—

## ■ Remote control

Problem	Cause	Remedy	Refer to page
<b>The remote control does not work nor function properly.</b>	Wrong distance or angle.	The remote control will function within a maximum range of 6 m (20 feet) and no more than 30 degrees off-axis from the front panel.	8
	Direct sunlight or lighting (from an inverter type of fluorescent lamp, etc.) is striking the remote control sensor of this unit.	Reposition the unit.	—
	The batteries are weak.	Replace all batteries with new ones and press RESET.	3
	The internal microcomputer has "frozen".	Press RESET on the remote control.	3
<b>The remote control does not "learn" new functions. (The TRANSMIT indicator does not light up nor flash.)</b>	The batteries of this remote control and/or the other remote control are too weak.	Replace the batteries (and press RESET on the remote control).	3
	The distance between the two remote controls is too much or too little.	Place the remote controls at the proper distance.	55
	The signal coding or modulation of the other remote control is not compatible with this remote control.	Learning is not possible.	55
	Memory capacity is full.	Further learning is not possible without deleting unnecessary functions.	56, 59, 60
	The internal microcomputer has "frozen".	Press RESET on the remote control.	3
<b>Continuous functions such as volume adjustment are learned, but operate only for a moment before stopping.</b>	The learning process is incomplete.	Be sure to press and hold the function button on the other remote control until TRANSMIT begins flashing slowly.	56

After this unit has been exposed to a strong external electric shock (such as lightning and strong static electricity) or if you mishandle the operation of this unit, it may not function properly. In these cases, set this unit in the standby mode, disconnect the power cord, plug it back in after 30 seconds, and start operating.

# SPECIFICATIONS

## AUDIO SECTION

- Minimum RMS Output Power for Main, Center, Rear
  - 20 Hz to 20 kHz, 0.04% THD, 8 ohms ..... 100 W
  - 1 kHz, 0.04% THD, 8 ohms ..... 105 W
- Maximum Power (EIAJ)
  - [China and general models]
  - 1 kHz, 10% THD, 8 ohms ..... 140 W
- Dynamic Power (IHF)
  - 8/6/4/2 ohms ..... 125/160/195/230 W
  - [U.S.A. model] 135/170/205/245 W
- Damping Factor
  - 20 Hz to 20 kHz, 8 ohms ..... 80 or more
- Frequency Response
  - CD to Main L/R ..... 10 Hz to 100 kHz, -3 dB
- Total Harmonic Distortion
  - 20 Hz to 20 kHz, 50 W, 8 ohms, Main L/R ..... 0.04%
- Signal to Noise Ratio (IHF-A Network)
  - PHONO MM to REC OUT (5 mV, shorted)
  - [U.S.A., Canada, China and general models] ..... 86 dB
  - [Australia and Singapore models] ..... 81 dB
  - CD (200 mV, shorted) to Main L/R, Effect Off ..... 98 dB
- Residual Noise (IHF-A Network)
  - Main L/R ..... 150  $\mu$ V or less
- Channel Separation (1 kHz/10 kHz)
  - CD (5.1 kohms terminated) to Main L/R ..... 60 dB/45 dB
- Tone Control (Main L/R)
  - BASS Boost/Cut .....  $\pm 10$  dB/50 Hz
  - TREBLE Boost/Cut .....  $\pm 10$  dB/20 kHz
  - BASS EXTENSION ..... +6 dB/60 Hz
- Phones Output ..... 150 mV/100 ohms
- Input Sensitivity
  - CD, etc ..... 150 mV/47 kohms
  - PHONO ..... 2.5 mV/47 kohms
  - 6CH INPUT ..... 150 mV/40 - 47 kohms
- Output Level
  - REC OUT ..... 150 mV/0.9 kohms
  - PRE OUT ..... 2.6 V/1.2 kohms
  - SUBWOOFER ..... 4.0 V/1.2 kohms

## VIDEO SECTION

- Video Signal Type ..... NTSC or PAL
- Composite Video Signal Level ..... 1 Vp-p/75 ohms
- S-Video Signal Level
  - Y ..... 1 Vp-p/75 ohms
  - C ..... 0.286 Vp-p/75 ohms
- Component Video Signal Level
  - Y ..... 1 Vp-p/75 ohms
  - Pb/Cb, Pr/Cr ..... 0.7 Vp-p/75 ohms
- Signal to Noise Ratio ..... 50 dB
- Frequency Response (MONITOR OUT)
  - Composite, S-Video ..... 5 Hz to 10 MHz, -3 dB
  - Component ..... DC to 25 MHz, -3 dB

## FM SECTION

- Tuning Range
  - [U.S.A. and Canada models] ..... 87.5 to 107.9 MHz
  - [Others] ..... 87.50 to 108.00 MHz
- 50 dB Quieting Sensitivity (IHF, 100% mod.)
  - Mono/Stereo ..... 2.0  $\mu$ V (17.3 dBf)/25  $\mu$ V (39.2 dBf)
- Selectivity (400 kHz) ..... 70 dB
- Signal to Noise Ratio (IHF)
  - Mono/Stereo ..... 76 dB/70 dB
- Harmonic Distortion (1 kHz)
  - Mono/Stereo ..... 0.2%/0.3%
- Stereo Separation (1 kHz) ..... 45 dB
- Frequency Response ..... 20 Hz to 15 kHz +0.5, -2 dB

## AM SECTION

- Tuning Range ..... 530/531 to 1710/1611 kHz
- Usable Sensitivity ..... 300  $\mu$ V/m

## GENERAL

- Power Supply
  - [U.S.A. and Canada models] ..... AC 120 V/60 Hz
  - [Australia model] ..... AC 240 V/50 Hz
  - [Singapore model] ..... AC 230 V/50 Hz
  - [China model] ..... AC 220 V/50 Hz
  - [General model] ..... AC 110/120/220/240 V, 50/60Hz
- Power Consumption ..... approx. 320 W/360 VA
- Standby Mode ..... approx. 1.5 W
- AC Outlets (Total 100 W/1A maximum) ..... 2 (SWITCHED)
- [Australia model] ..... 1 (SWITCHED)
- Dimension (W x H x D)
  - ..... 435 x 171 x 432 mm (17-1/8" x 6-3/4" x 17")
- Weight ..... 15 kg (33 lbs)
- Accessories ..... Remote Control
- ..... Batteries
- ..... AM loop antenna
- ..... Indoor FM antenna
- ..... Quick Reference Card

\* Specifications are subject to change without notice.



---

YAMAHA ELECTRONICS CORPORATION, USA 6660 ORANGETHORPE AVE., BUENA PARK, CALIF. 90620, U.S.A.  
YAMAHA CANADA MUSIC LTD. 135 MILNER AVE., SCARBOROUGH, ONTARIO M1S 3R1, CANADA  
YAMAHA ELECTRONIK EUROPA G.m.b.H. SIEMENSSTR. 22-34, 25462 RELINGEN BEI HAMBURG, F.R. OF GERMANY  
YAMAHA ELECTRONIQUE FRANCE S.A. RUE AMBROISE CROIZAT BP70 CROISSY-BEAUBOURG 77312 MARNE-LA-VALLEE CEDEX02, FRANCE  
YAMAHA ELECTRONICS (UK) LTD. YAMAHA HOUSE, 200 RICKMANSWORTH ROAD WATFORD, HERTS WD1 7JS, ENGLAND  
YAMAHA SCANDINAVIA A.B. J A WETTERGRENS GATA 1, BOX 30053, 400 43 VÄSTRA FRÖLUNDA, SWEDEN  
YAMAHA MUSIC AUSTRALIA PTY, LTD. 17-33 MARKET ST., SOUTH MELBOURNE, 3205 VIC., AUSTRALIA

YAMAHA CORPORATION  
Printed in Malaysia ID V641380

# Quick Reference Card

## Remote Control

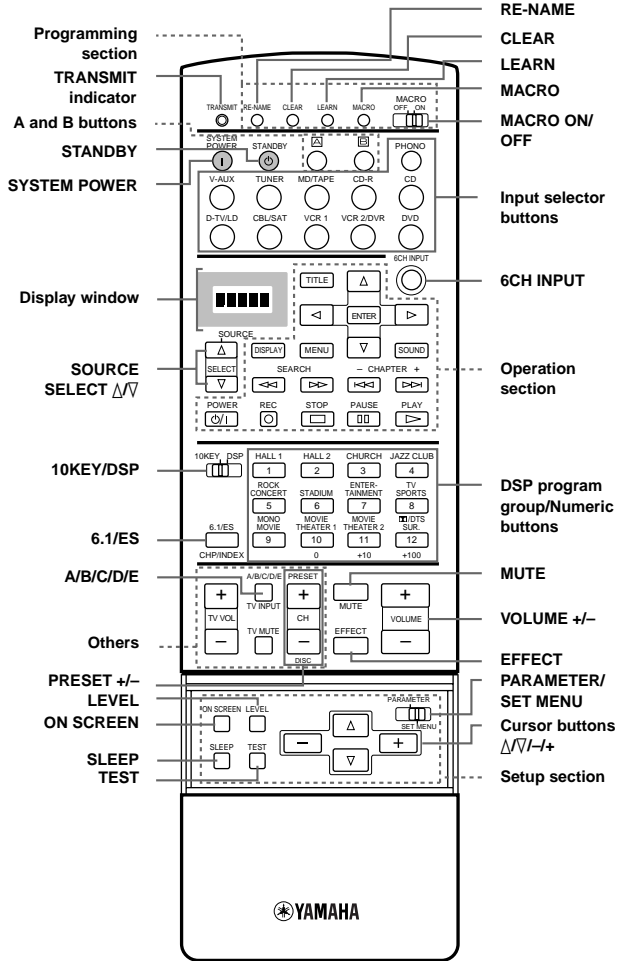

## TUNER

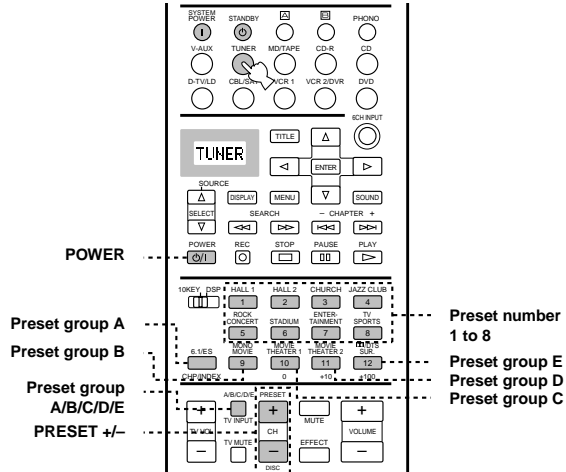

## CD

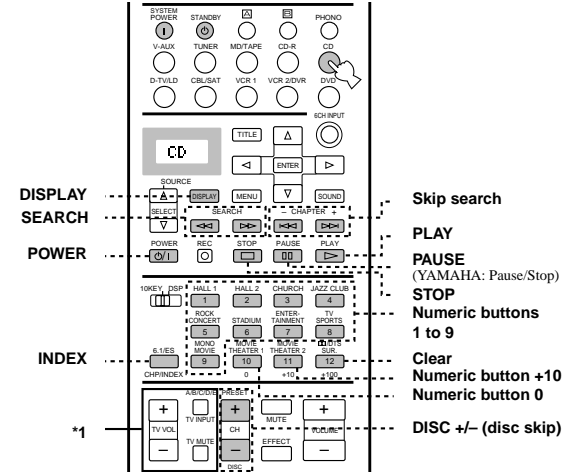

## MD

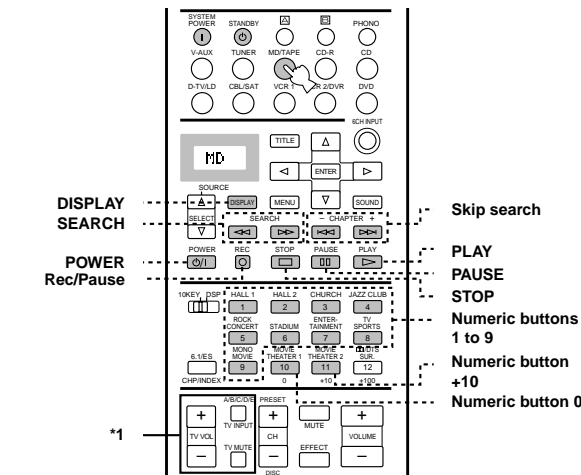

## CD-R

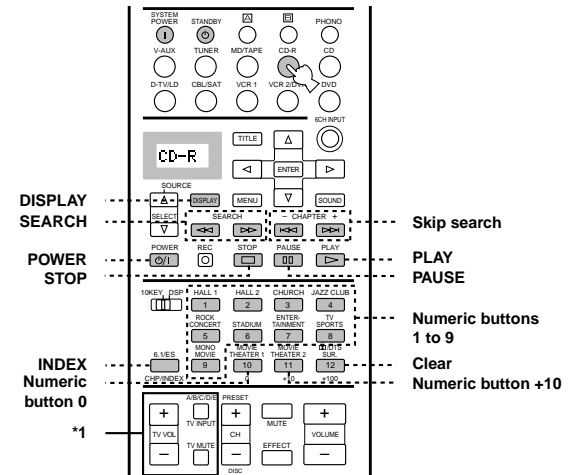

# Quick Reference Card

## LD (A)

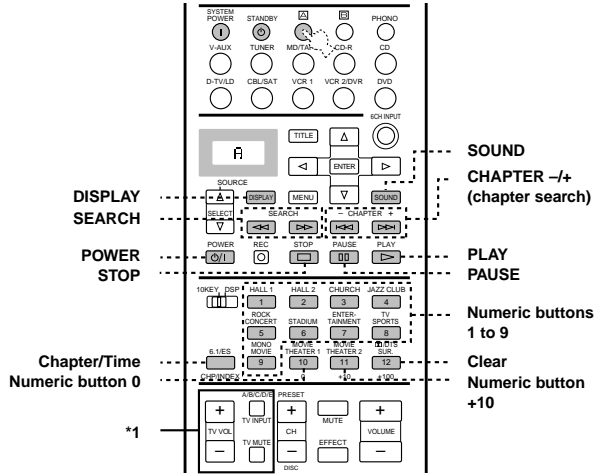

## VCR

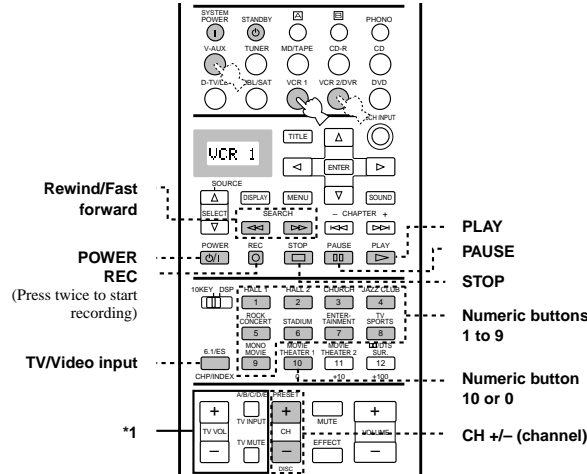

## CBL/SAT (CBSAT)

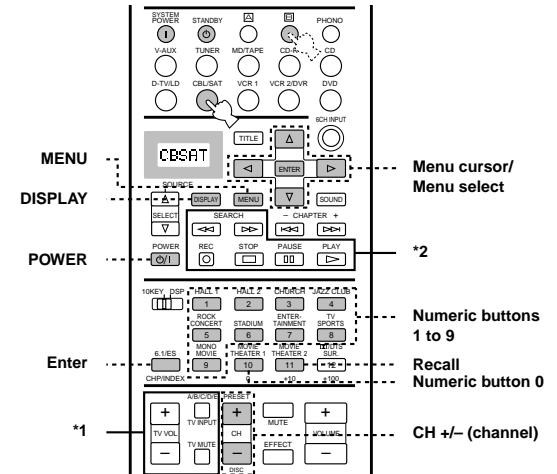

## DVD

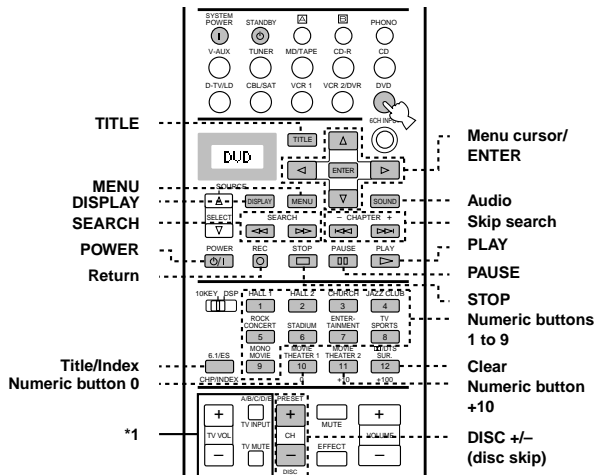

## TV (TV/LD)

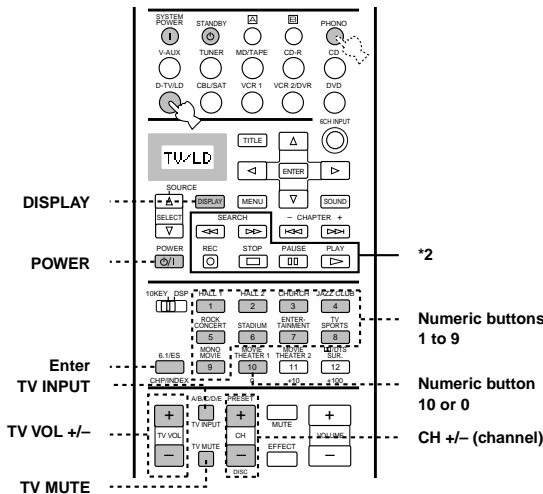

- \*1
- TV VOL +/-, TV INPUT, and TV MUTE function if you have set up the manufacturer code for your TV in the D-TV/LD or PHONO area.
  - Commandes TV VOL +/-, TV INPUT et TV MUTE si l'on a programmé le code fabricant du téléviseur dans la section D-TV/LD ou PHONO.
  - TV VOL +/-, TV INPUT- und TV MUTE-Funktion, falls Sie den Herstellercode für Ihr Fernsehgerät im Bereich D-TV/LD oder PHONO eingestellt haben.
  - Knapparna TV VOL +/-, TV INPUT- och TV MUTE-funktion, om du ställt in tillverkar-koderna för din TV i D-TV/LD-området eller PHONO-området.
  - TV VOL +/-, TV INPUT e TV MUTE sono operativi se nell'area D-TV/LD o PHONO è stato impostato il codice del fabbricante del televisore di cui si dispone.
  - Funciones TV VOL +/-, TV INPUT y TV MUTE si ha ajustado el código de fabricante para su televisor en el área D-TV/LD o PHONO.
  - TV VOL +/- (tv-volumeniveau), TV INPUT (tv-ingangsbron) en TV MUTE (tv-dempingsfunctie) als u de fabrikantcode voor uw tv hebt ingesteld in het D-TV/LD- of PHONO-bediensgedeelte.
  - TV VOL (电视音量) +/-, TV INPUT (电视输入) 和 TV MUTE (电视静音) 功能 (如果您已经为您的电视在 D-TV/LD 或 PHONO 区域设定了厂家代码时。)
- \*2
- You can control your VCR if you have set up the code for VCR 1.
  - Permet de commander le magnétoscope si l'on a programmé le code fabricant pour VCR 1.
  - Sie können Ihren Videorecorder bedienen, falls Sie den Code für VCR 1 eingestellt haben.
  - Du kan styra din videobandspelare om du ställt in koden för VCR 1.
  - Se è stato impostato il codice di VCR 1 è possibile comandare il videoregistratore di cui si dispone.
  - Puede controlar su videoreproductor si ha ajustado el código para VCR 1.
  - U kunt uw videorecorder bedienen als u de fabrikantcode voor VCR 1 hebt ingesteld.
  - 如果您已经设定了 VCR 1 代码, 您可以控制您的 VCR。