



MIXING CONSOLE

MGP32X MGP24X

Owner's Manual

PRECAUTIONS

pages 4 to 5

Setup

pages 7 to 9

Troubleshooting

pages 40 to 41

Made for

 iPod  iPhone

EN

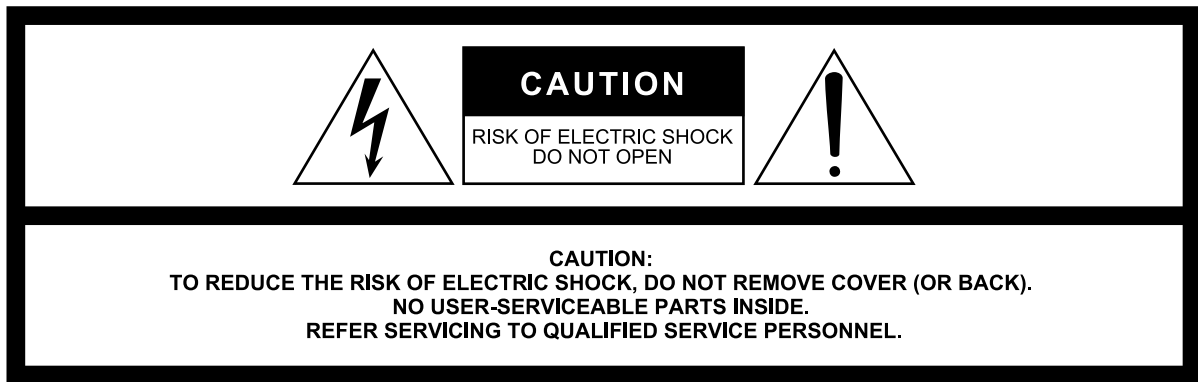

The above warning is located on the rear of the unit.
L'avertissement ci-dessus est situé sur le arrière de l'appareil.

Explanation of Graphical Symbols Explication des symboles

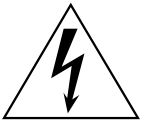

The lightning flash with arrowhead symbol within an equilateral triangle is intended to alert the user to the presence of uninsulated "dangerous voltage" within the product's enclosure that may be of sufficient magnitude to constitute a risk of electric shock to persons.
L'éclair avec une flèche à l'intérieur d'un triangle équilatéral est destiné à attirer l'attention de l'utilisateur sur la présence d'une « tension dangereuse » non isolée à l'intérieur de l'appareil, pouvant être suffisamment élevée pour constituer un risque d'électrocution.



The exclamation point within an equilateral triangle is intended to alert the user to the presence of important operating and maintenance (servicing) instructions in the literature accompanying the product.
Le point d'exclamation à l'intérieur d'un triangle équilatéral est destiné à attirer l'attention de l'utilisateur sur la présence d'instructions importantes sur l'emploi ou la maintenance (réparation) de l'appareil dans la documentation fournie.

IMPORTANT SAFETY INSTRUCTIONS

- 1 Read these instructions.
- 2 Keep these instructions.
- 3 Heed all warnings.
- 4 Follow all instructions.
- 5 Do not use this apparatus near water.
- 6 Clean only with dry cloth.
- 7 Do not block any ventilation openings. Install in accordance with the manufacturer's instructions.
- 8 Do not install near any heat sources such as radiators, heat registers, stoves, or other apparatus (including amplifiers) that produce heat.
- 9 Do not defeat the safety purpose of the polarized or grounding-type plug. A polarized plug has two blades with one wider than the other. A grounding type plug has two blades and a third grounding prong. The wide blade or the third prong are provided for your safety. If the provided plug does not fit into your outlet, consult an electrician for replacement of the obsolete outlet.
- 10 Protect the power cord from being walked on or pinched particularly at plugs, convenience receptacles, and the point where they exit from the apparatus.
- 11 Only use attachments/accessories specified by the manufacturer.
- 12 Use only with the cart, stand, tripod, bracket, or table specified by the manufacturer, or sold with the apparatus. When a cart is used, use caution when moving the cart/apparatus combination to avoid injury from tip-over.
- 13 Unplug this apparatus during lightning storms or when unused for long periods of time.
- 14 Refer all servicing to qualified service personnel. Servicing is required when the apparatus has been damaged in any way, such as power-supply cord or plug is damaged, liquid has been spilled or objects have fallen into the apparatus, the apparatus has been exposed to rain or moisture, does not operate normally, or has been dropped.



WARNING

TO REDUCE THE RISK OF FIRE OR ELECTRIC SHOCK, DO NOT EXPOSE THIS APPARATUS TO RAIN OR MOISTURE.

(UL60065_03)

PRÉCAUTIONS CONCERNANT LA SÉCURITÉ

- 1 Lire ces instructions.
- 2 Conserver ces instructions.
- 3 Tenir compte de tous les avertissements.
- 4 Suivre toutes les instructions.
- 5 Ne pas utiliser ce produit à proximité d'eau.
- 6 Nettoyer uniquement avec un chiffon propre et sec.
- 7 Ne pas bloquer les orifices de ventilation. Installer l'appareil conformément aux instructions du fabricant.
- 8 Ne pas installer l'appareil à proximité d'une source de chaleur comme un radiateur, une bouche de chaleur, un poêle ou tout autre appareil (y compris un amplificateur) produisant de la chaleur.
- 9 Ne pas modifier le système de sécurité de la fiche polarisée ou de la fiche de terre. Une fiche polarisée dispose de deux broches dont une est plus large que l'autre. Une fiche de terre dispose de deux broches et d'une troisième pour le raccordement à la terre. Cette broche plus large ou cette troisième broche est destinée à assurer la sécurité de l'utilisateur. Si la fiche équipant l'appareil n'est pas compatible avec les prises de courant disponibles, faire remplacer les prises par un électricien.
- 10 Acheminer les cordons d'alimentation de sorte qu'ils ne soient pas piétinés ni coincés, en faisant tout spécialement attention aux fiches, prises de courant et au point de sortie de l'appareil.
- 11 Utiliser exclusivement les fixations et accessoires spécifiés par le fabricant.
- 12 Utiliser exclusivement le chariot, le stand, le trépied, le support ou la table recommandés par le fabricant ou vendus avec cet appareil. Si l'appareil est posé sur un chariot, déplacer le chariot avec précaution pour éviter tout risque de chute et de blessure.
- 13 Débrancher l'appareil en cas d'orage ou lorsqu'il doit rester hors service pendant une période prolongée.
- 14 Confier toute réparation à un personnel qualifié. Faire réparer l'appareil s'il a subi tout dommage, par exemple si la fiche ou le cordon d'alimentation est endommagé, si du liquide a coulé ou des objets sont tombés à l'intérieur de l'appareil, si l'appareil a été exposé à la pluie ou à de l'humidité, si l'appareil ne fonctionne pas normalement ou est tombé.

AVERTISSEMENT

POUR RÉDUIRE LES RISQUES D'INCENDIE OU DE DÉCHARGE ÉLECTRIQUE, N'EXPOSEZ PAS CET APPAREIL À LA PLUIE OU À L'HUMIDITÉ.

(UL60065_03)

Contents

PRECAUTIONS	4	Using Graphic EQ	28
Introduction.....	6	About the graphic EQ (GEQ).....	28
Main features	6	Setting the GEQ.....	28
Setup.....	7	Finding and removing feedback	29
Preparing the power supply	7	Calling up/saving the GEQ program.....	30
Connections	7	Using the Compressor	31
Powering up the system	7	About the master compressor	31
Getting sound to the speakers.....	7	Specifying the compressor settings	31
Setup example.....	8	Calling up/saving the compressor program ..	32
Controls and Connectors	10	Recording/Playing back	33
Top panel	10	About USB device recording/playing back	33
Rear panel.....	10	Recording to a USB device.....	33
Channel control block	11	Playing back songs from a USB device	34
Mono input section	11	Playing back songs from an iPod/iPhone	36
Stereo input section.....	11	Specifying the recording/playback settings ..	36
Master control block	15	Using Other Functions	37
USB device recorder section.....	15	Applying the Low Pass Filter (LPF)	37
iPod/iPhone section.....	15	Using the Ducker function.....	37
Display section	16	Using the Leveler function	38
Meter section.....	16	Initializing the unit to the factory default	
FX RTN (effect return) section	17	settings (resetting user memory).....	39
SEND MASTER section	18	Troubleshooting	40
MATRIX section	18	Appendix	42
USB IN/iPod IN section	19	Message List.....	42
PHONES/MONITOR section.....	19	Effect Program List	43
TALKBACK section	20	Parameter List	44
GROUP section.....	20	Jack List.....	46
MONO master section.....	21	Dimensions.....	47
STEREO master section	21	Specifications	48
Rear input/output block.....	22	Index.....	51
Channel I/O connectors section	22	Block Diagram and Level Diagram	52
Master I/O connectors section.....	22		
Power section.....	23		
Basic Operations and Display	24		
Viewing the display.....	24		
Operations of the screen.....	25		
Using Effects (FX).....	26		
Applying effects	26		
Detailed effect settings	26		
Applying two effects simultaneously	27		
Displaying FX1 and FX2 together	27		

PRECAUTIONS

PLEASE READ CAREFULLY BEFORE PROCEEDING

* Please keep this manual in a safe place for future reference.



WARNING

Always follow the basic precautions listed below to avoid the possibility of serious injury or even death from electrical shock, short-circuiting, damages, fire or other hazards. These precautions include, but are not limited to, the following:

Power supply/Power cord

- Do not place the power cord near heat sources such as heaters or radiators, and do not excessively bend or otherwise damage the cord, place heavy objects on it, or place it in a position where anyone could walk on, trip over, or roll anything over it.
- Only use the voltage specified as correct for the device. The required voltage is printed on the name plate of the device.
- Use only the supplied power cord/plug.
If you intend to use the device in an area other than in the one you purchased, the included power cord may not be compatible. Please check with your Yamaha dealer.
- Check the electric plug periodically and remove any dirt or dust which may have accumulated on it.
- Be sure to connect to an appropriate outlet with a protective grounding connection. Improper grounding can result in electrical shock.

Do not open

- This device contains no user-serviceable parts. Do not open the device or attempt to disassemble the internal parts or modify them in any way. If it should appear to be malfunctioning, discontinue use immediately and have it inspected by qualified Yamaha service personnel.

Water warning

- Do not expose the device to rain, use it near water or in damp or wet conditions, or place on it any containers (such as vases, bottles or glasses) containing liquids which might spill into any openings. If any liquid such as water seeps into the device, turn off the power immediately and unplug the power cord from the AC outlet. Then have the device inspected by qualified Yamaha service personnel.
- Never insert or remove an electric plug with wet hands.

Fire warning

- Do not put burning items, such as candles, on the unit. A burning item may fall over and cause a fire.

If you notice any abnormality

- When one of the following problems occur, immediately turn off the power switch and disconnect the electric plug from the outlet. Then have the device inspected by Yamaha service personnel.
 - The power cord or plug becomes frayed or damaged.
 - It emits unusual smells or smoke.
 - Some object has been dropped into the instrument.
 - There is a sudden loss of sound during use of the device.
- If this device should be dropped or damaged, immediately turn off the power switch, disconnect the electric plug from the outlet, and have the device inspected by qualified Yamaha service personnel.



CAUTION

Always follow the basic precautions listed below to avoid the possibility of physical injury to you or others, or damage to the device or other property. These precautions include, but are not limited to, the following:

Power supply/Power cord

- When removing the electric plug from the device or an outlet, always hold the plug itself and not the cord. Pulling by the cord can damage it.
- Remove the electric plug from the outlet when the device is not to be used for extended periods of time, or during electrical storms.

Location

- Do not place the device in an unstable position where it might accidentally fall over.
- Do not block the vents. This device has ventilation holes at the bottom and sides to prevent the internal temperature from becoming too high. In particular, do not place the device on its side or upside down. Inadequate ventilation can result in overheating, possibly causing damage to the device(s), or even fire.
- Do not place the device in a location where it may come into contact with corrosive gases or salt air. Doing so may result in malfunction.

- Before moving the device, remove all connected cables.
- When setting up the device, make sure that the AC outlet you are using is easily accessible. If some trouble or malfunction occurs, immediately turn off the power switch and disconnect the plug from the outlet. Even when the power switch is turned off, electricity is still flowing to the product at the minimum level. When you are not using the product for a long time, make sure to unplug the power cord from the wall AC outlet.

Connections

- Before connecting the device to other devices, turn off the power for all devices. Before turning the power on or off for all devices, set all volume levels to minimum.

Maintenance

- Remove the power plug from the AC outlet when cleaning the device.

Handling caution

- Do not insert your fingers or hands in any gaps or openings on the device (vents, ports, etc.).
- Avoid inserting or dropping foreign objects (paper, plastic, metal, etc.) into any gaps or openings on the device (vents, ports, etc.) If this happens, turn off the power immediately and unplug the power cord from the AC outlet. Then have the device inspected by qualified Yamaha service personnel.
- Do not rest your weight on the device or place heavy objects on it, and avoid use excessive force on the buttons, switches or connectors.
- Do not use speakers or headphones for a long period of time at a high or uncomfortable volume level, since this can cause permanent hearing loss. If you experience any hearing loss or ringing in the ears, consult a physician.

Yamaha cannot be held responsible for damage caused by improper use or modifications to the device, or data that is lost or destroyed.

Always turn the power off when the device is not in use.

NOTICE

To avoid the possibility of malfunction/damage to the product, damage to data, or damage to other property, follow the notices below.

■ Handling and Maintenance

- Do not use the device in the vicinity of a TV, radio, stereo equipment, mobile phone, or other electric devices. Otherwise, the device, TV, or radio may generate noise.
- Do not expose the device to excessive dust or vibrations, or extreme cold or heat (such as in direct sunlight, near a heater, or in a car during the day) to prevent the possibility of panel disfiguration, damage to the internal components or unstable operation.
- Do not place vinyl, plastic or rubber objects on the device, since this might discolor the panel of this device.
- When cleaning the device, use a dry and soft cloth. Do not use paint thinners, solvents, cleaning fluids, or chemical-impregnated wiping cloths.
- Condensation can occur in the device due to rapid, drastic changes in ambient temperature—when the device is moved from one location to another, or air conditioning is turned on or off, for example. Using the device while condensation is present can cause damage. If there is reason to believe that condensation might have occurred, leave the device for several hours without turning on the power until the condensation has completely dried out.
- Avoid setting all equalizer controls and faders to their maximum. Depending on the condition of the connected devices, doing so may cause feedback and may damage the speakers.
- Do not apply oil, grease, or contact cleaner to the faders. Doing so may cause problems with electrical contact or fader motion.
- When turning on the AC power in your audio system, always turn on the power amplifier LAST, to avoid speaker damage. When turning the power off, the power amplifier should be turned off FIRST for the same reason.

■ Saving data

- To protect against data loss due to media damage, we recommend that important data that has been saved via the USB device recorder to a USB device should also be saved to your computer or an external USB device.

■ Connectors

XLR-type connectors are wired as follows (IEC60268 standard): pin 1: ground, pin 2: hot (+), and pin 3: cold (-). Insert TRS phone jacks are wired as follows: sleeve: ground, tip: send, and ring: return.

Information

■ About copyrights

- Copying of the commercially available musical data including but not limited to MIDI data and/or audio data is strictly prohibited except for your personal use.

■ About this manual

- The illustrations and LCD screens as shown in this manual are for instructional purposes only, and may appear somewhat different from those on your device.
- Throughout this manual, all panel illustrations show the panel of the MGP32X.
- The company names and product names in this manual are the trademarks or registered trademarks of their respective companies.

iPod™, iPhone™

iPhone, iPod, iPod classic, iPod nano, and iPod touch are trademarks of Apple Inc., registered in the U.S. and other countries.



"Made for iPod" and "Made for iPhone" mean that an electronic accessory has been designed to connect specifically to iPod or iPhone respectively, and has been certified by the developer to meet Apple performance standards. Apple is not responsible for the operation of this device or its compliance with safety and regulatory standards. Please note that the use of this accessory with iPod or iPhone may affect wireless performance.

Introduction

Thank you for purchasing the Yamaha MGP32X/MGP24X mixing console.

Please read this manual thoroughly to make the best use of the mixing console for the longest possible period of time.

After reading this manual, please keep it available for future reference.

Main features

D-PRE (Discrete Class-A MIC preamp)

Mono input channels are equipped with Class-A discrete microphone preamplifiers. The head amplifier features an inverted Darlington circuit* used in high-end audio devices, and reproduces low frequencies with exceptionally musical characteristics as well as sustained high frequencies. Independent toggle switching of +48V phantom power and 26dB (pad) on each channel.

* **Inverted Darlington circuit:** An amplifying method for eliminating the nonlinear characteristics of the amplifier element and suppressing the distortion. The circuit features highly musical phase characteristics.

X-pressive EQ

The shelving EQ (low/high) on the mono input channels features Xpressive EQ, which effectively models analog EQ utilizing Yamaha's famed VCM (Virtual Circuitry Modeling) technology. We analyzed vintage EQ analog circuits and redesigned the technology specifically for the MGP to create an EQ with exceptionally musical characteristics. Furthermore, the cutoff frequency can also be adjusted, enhancing use of the EQ in sound reinforcement applications, and extending the sonic control range of the mixer.

USB device recorder

A USB device recorder is built into the mixer for recording mixed audio to a USB device as an audio file, and for playing back music saved in the USB device by assigning it to the desired channel output or bus output. Supported file formats are MP3 (MPEG-1 Audio Layer-3) and WAV for recording and MP3, WAV, and AAC for playback.

Stereo master – COMP and GEQ

The stereo master is equipped with a compressor (COMP) or multiband compressor that adjusts the sound pressure of the output signal, and with a graphic equalizer (GEQ) that adjusts sound quality such as feedback.

Digital effects — REV-X and SPX

Two powerful digital effect blocks are built into the mixer: REV-X (8 types) and SPX (16 types). REV-X gives you a high-density, richly reverberant sound ambience, with smooth attenuation, spread and depth that work together to enhance the original sound. The versatile SPX block features a variety of effect applications, such as reverb, delay, and modulation effects, along with complex combinations of multiple effects.

Convenient, practical functions for events – Ducker, Leveler, and Stereo Image

The mixer features three exceptionally convenient features for the stereo input channels: Ducker, Leveler and Stereo Image. The ducker function automatically lowers the level of background music to accommodate the voice of an announcer coming in on another channel. The leveler function automatically maintains a consistent sound volume, even when using sound sources that have different mastering levels. Stereo image narrows the pan balance of the stereo sound source, and changes stereo signals to mono. This is useful in restaurants and other spaces where the left and right speakers are distantly positioned, or when you input accompaniment sound to the left channel and vocal sound to the right and want a more natural stereo image.

USB port for playing and charging your iPod/iPhone

Digital audio output from the iPod/iPhone can be directly input to the unit, and the iPod/iPhone can be charged while connected.

About the models

The MGP32X and MGP24X feature a different number of monaural input channels and COMP control knobs. The MGP32X has 24 monaural input channels and the MGP24X has 16. The MGP32X is equipped with 16 COMP control knobs for channels 9-24 and the MGP24X with 8 COMP control knobs for channels 9-16.

Conventions in this manual

- Whenever there is a different number of channels or a different channel number for the same function between the MGP32X and the MGP24X, the number that applies only to the MGP24X model is enclosed in curly brackets { }. For example, “CH1-24 {CH1-16}” means channels 1-24 for the MGP32X and channels 1-16 for the MGP24X.

* “CH” is an abbreviation for channel.

- Control knobs on the panel are called “knobs.” Some knobs rotate from a minimum value to a maximum value, while others rotate endlessly.

MGP Editor

MGP Editor is a free software application that gives you additional control of your MGP mixer's DSP settings via your iPhone, iPod touch, and iPad. See the following web site to download the application.

http://www.yamahaproaudio.com/global/en/products/peripherals/applications/mgp_editor/

Included Accessories

- AC Power Cord
- Owner's manual (this book)

Setup

Preparing the power supply

1. Make sure that the power switch of the unit is set to the “O” position (off).

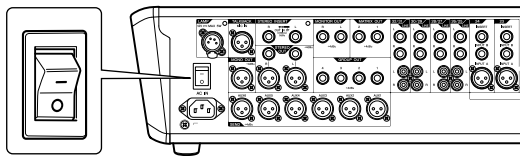

2. Connect the socket of the included power cord to the [AC IN] connector.
3. Plug the power cord into a power outlet.

⚠ CAUTION

- Unplug the power cord from the outlet when not using the mixer or during electrical storms.

Connections

1. Turn all the faders and GAIN knobs completely down.

GAIN knobs Power switch (rear panel)

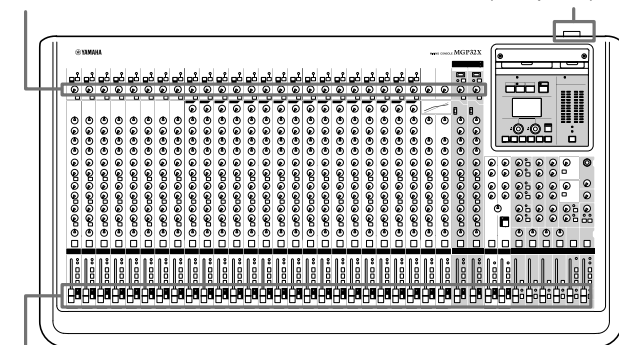

Faders

2. Connect speakers, microphones and/or instruments.

Refer to “Setup example” on pages 8-9 for more information on connections.

Powering up the system

To prevent an unwanted burst of noise from the speakers, power up the devices in the following order: peripheral devices (instrument, microphone, iPod) → MGP mixer → power amps (or powered speakers).

Reverse this order when turning the power off.

⚠ CAUTION

- Be sure to turn the power on/off in this order every time you use the mixer. Failure to do so may result in loud noise bursts that can damage your equipment, your ears, or both.

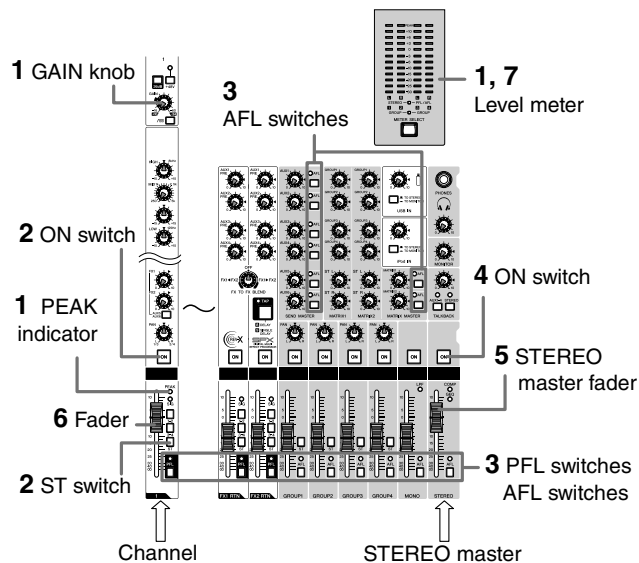

Getting sound to the speakers



1. While producing sound on your instrument or microphone, adjust the channel GAIN knobs so that the corresponding peak indicators flash briefly at the highest peak levels.

NOTE

- To use the level meter to get a more accurate reading of the incoming signal level, turn on the channel PFL switch. Adjust the GAIN knobs so that the PFL/AFL level meter indicator only occasionally rises above the “0” level.
- The gain (volume) level of the audio files in the USB device may be too high. Refer to the NOTE on page 35 to adjust the volume.
- Note that the PHONES jack or MONITOR OUT jacks output the pre-fader signal from all channels for which the PFL switch is ON, so that those signals can be monitored.

2. Turn on () the ON and ST (Stereo) switches for each channel you are using.
3. Make sure that all the PFL and AFL switches are off ().
4. Turn on () the ON switch of the STEREO master.
5. Raise the STEREO master fader to the 0 dB position.
6. Adjust the volume of each channel by moving its fader up and down.
7. Adjust the overall volume with the STEREO master fader.

The overall headphone level is adjusted with the PHONES knob.

NOTE

If the PEAK indicator lights frequently, slowly lower the channel faders a little to avoid distortion.

Setup example

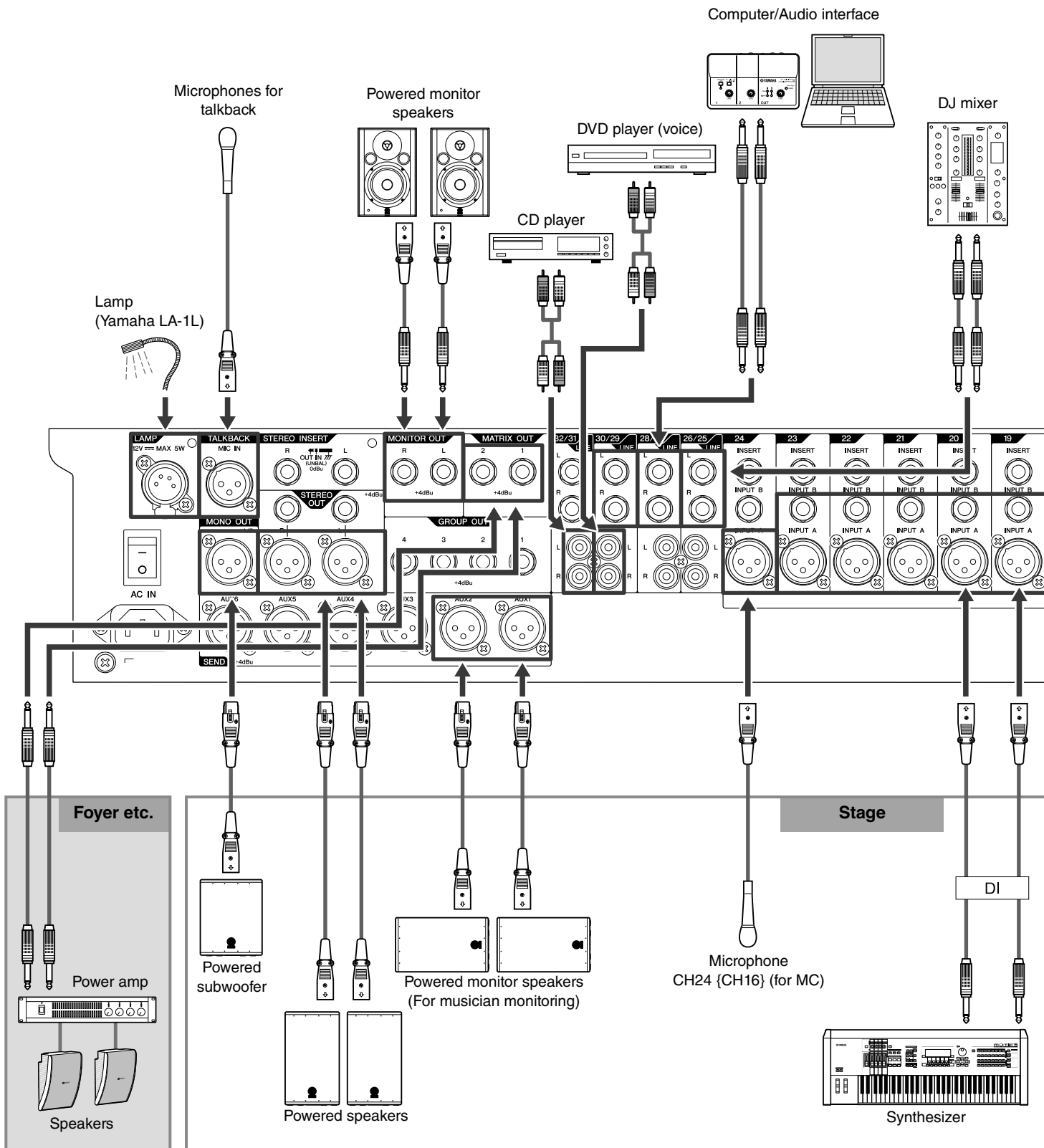

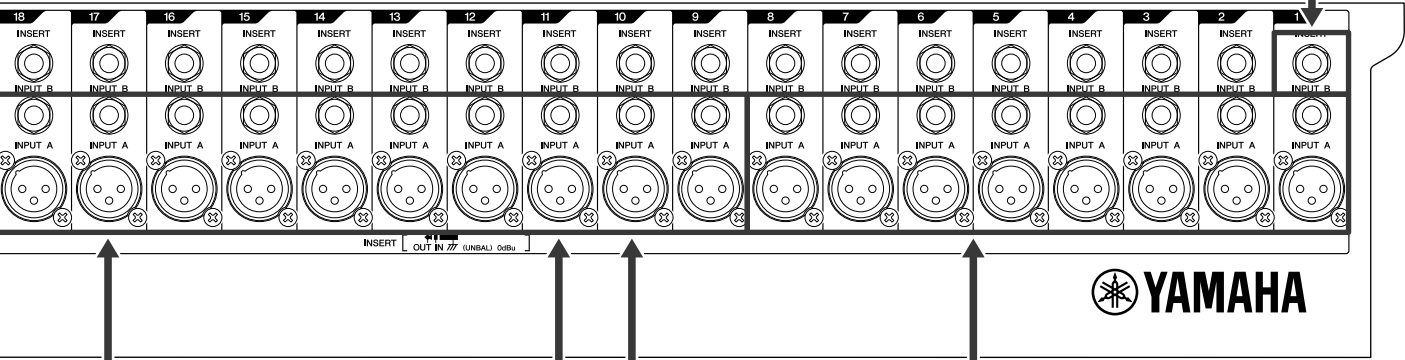
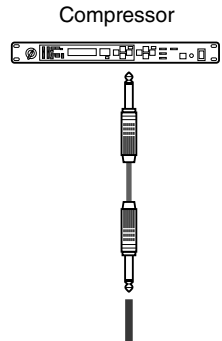
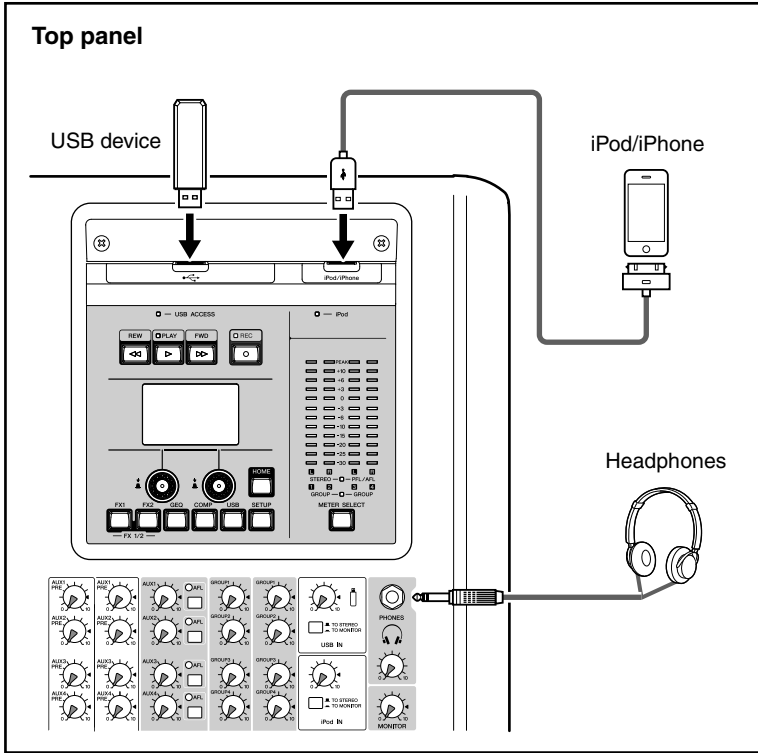

Rear panel
*The illustrations show the panel of the MGP32X.

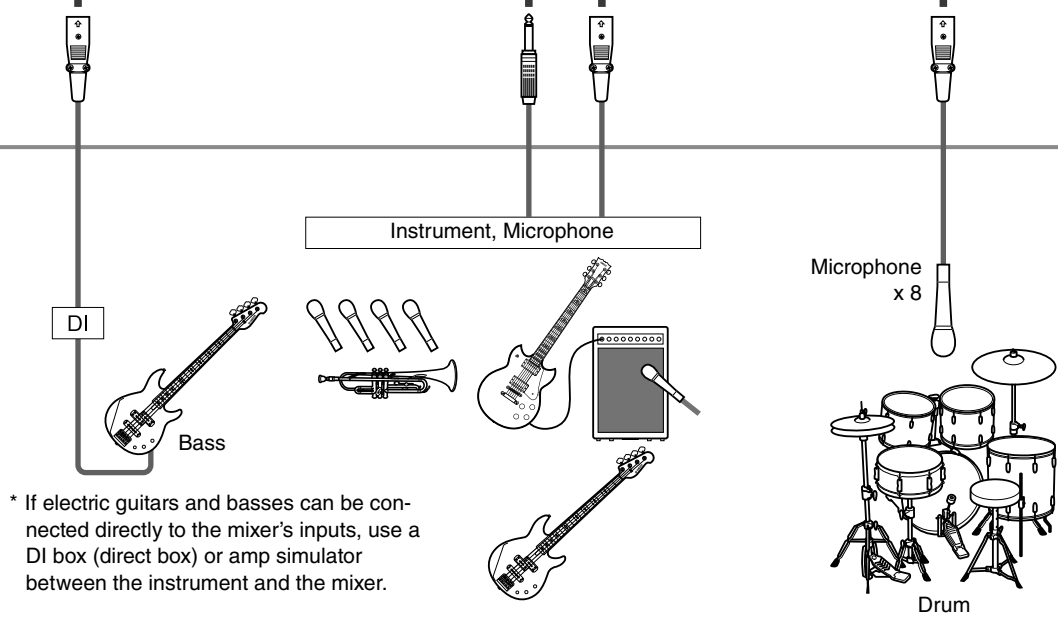

CAUTION

- When using a condenser microphone, set the +48V phantom switch to ON (page 11).

* If electric guitars and basses can be connected directly to the mixer's inputs, use a DI box (direct box) or amp simulator between the instrument and the mixer.

Controls and Connectors

Top panel

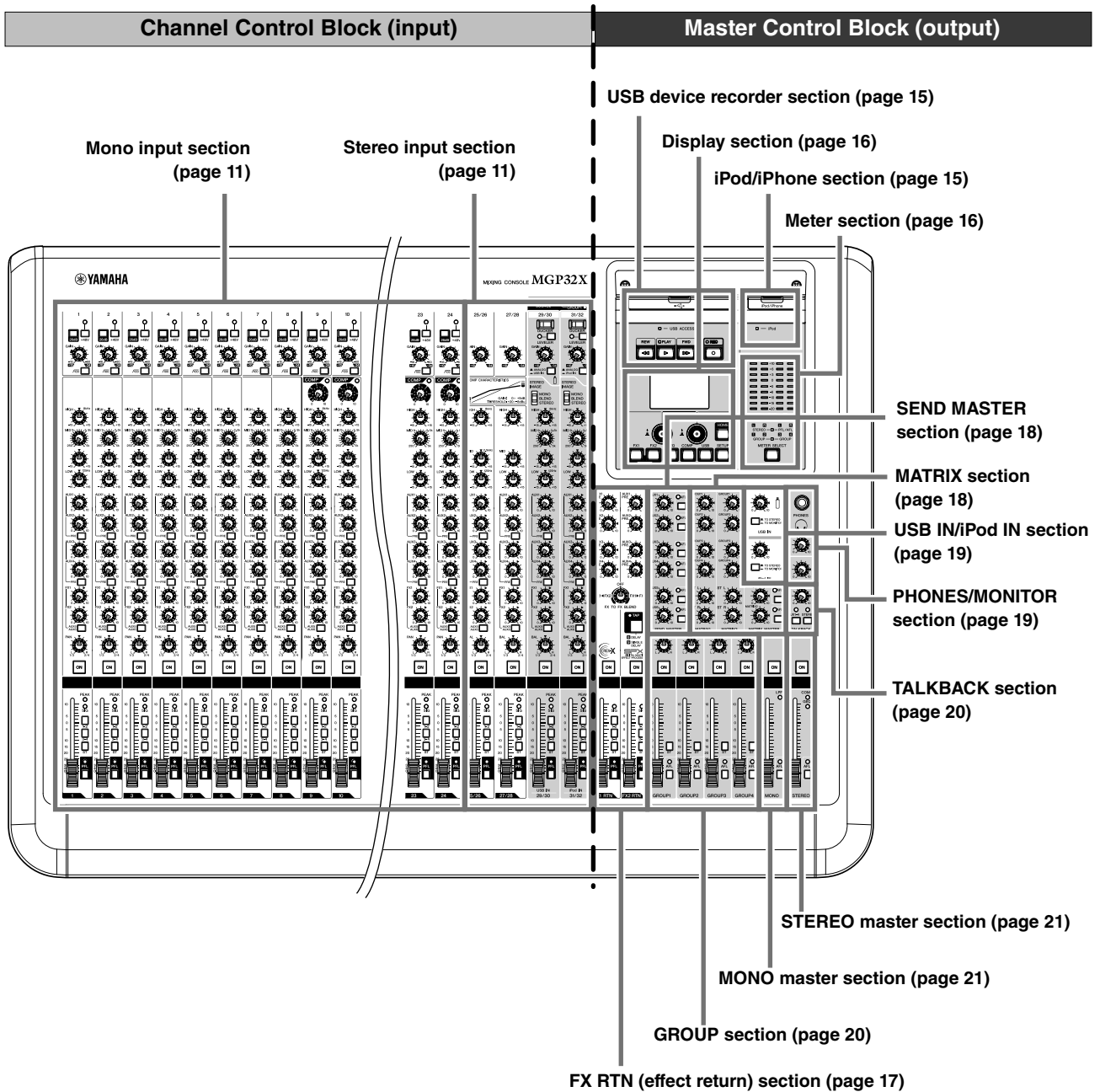

Rear panel

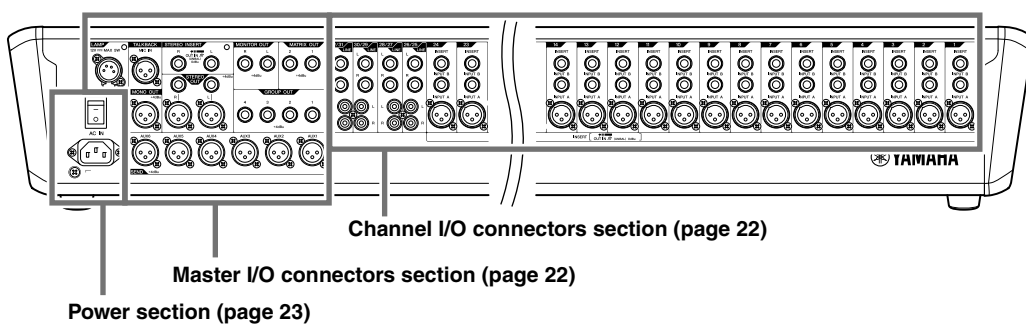

Channel control block

Mono input section

Stereo input section

Mono channels

1–24 (MGP32X)

1–16 (MGP24X)

Stereo channels

25–32 (MGP32X)

17–24 (MGP24X)

* ⑥-⑩ are for CH29/
30, CH31/32 {CH21/
22, CH23/24} only.

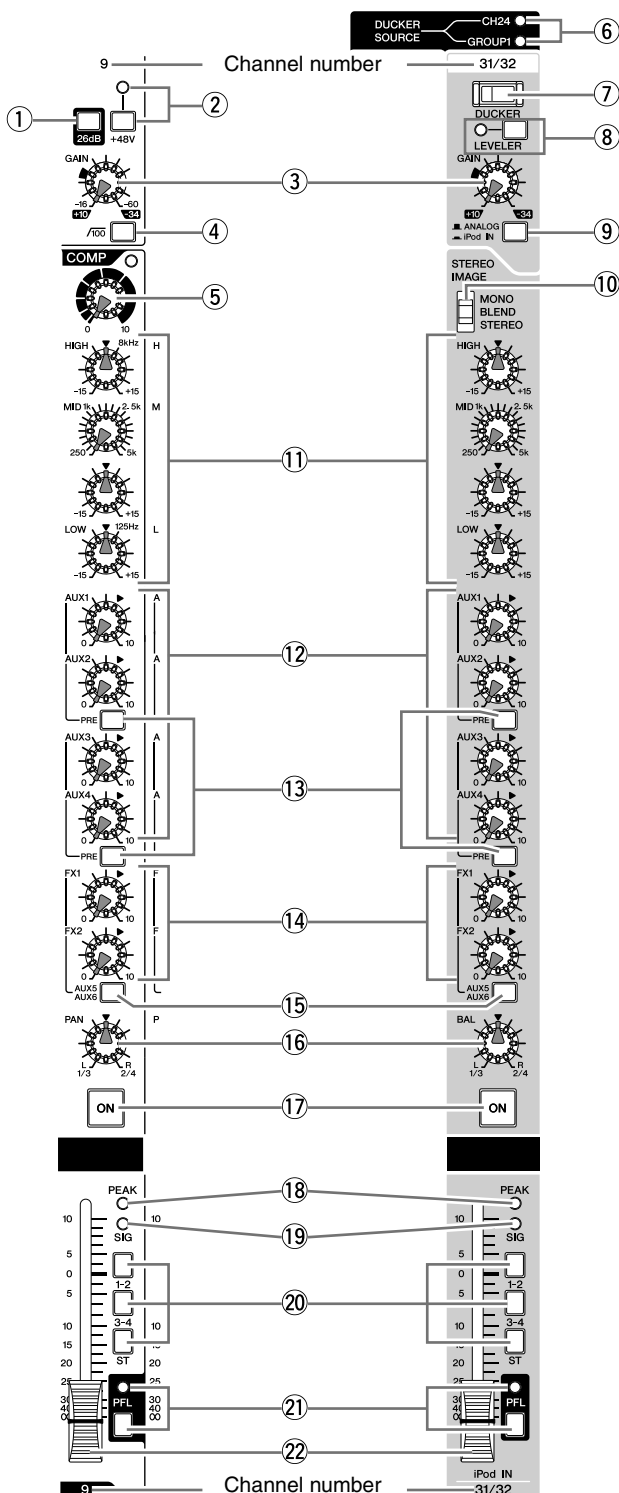

① **26dB (PAD) switch**

Turning this switch on () attenuates the input signal from the INPUT jack of the mono channel by 26dB. Turn this switch off () if you have connected a microphone or other device with a low input level to the channel. Turn it on () if you have connected a line-level device.

② **+48V switch and indicator**

Toggles phantom power on and off. When this switch is turned on (), the mixer supplies DC +48V power to INPUT A of XLR input jacks. Turn this switch on when using one or more phantom-powered condenser microphones. The indicator is on when the switch is on.

CAUTION

- Be sure to leave this switch off () if you do not need phantom power.
- When turning phantom power on (), follow the important precautions below, in order to prevent noise and possible damage to the mixer and external devices.
 - Turn this switch off when connecting a device that does not support phantom power to INPUT A of XLR input jacks
 - Do not connect/disconnect a cable to/from channels 1-24 {1-16} while this switch on.
 - Turn the mixer's output controls – STEREO master and GROUP faders- all the way down when turning phantom power on/off.

③ **GAIN knob**

Adjusts the sensitivity of the input signal. Monaural channels have a 26dB switch (①) that lets you change the range of this control. The adjustable sensitivity range is as follows.

Mono channel

26dB switch	Range
ON	-34dB to +10dB
OFF	-60dB to -16dB

NOTE

The stereo channel is fixed to a range of -34dB to +10dB.

④ **$\sqrt{100}$ (High Pass Filter) switch**

Turning this switch on () will apply a high-pass filter that attenuates frequencies below 100Hz in the signal by a slope of 12dB/octave.

⑤ **COMP knobs and indicator (Channel 9-24 {9-16})**

Adjusts the amount of compression applied to the channel. As the knob is turned to the right the compression ratio increases while the output gain is automatically adjusted accordingly. The result is smoother, more even dynamics because louder signals are attenuated while the overall level is boosted. The COMP indicator comes on when the compressor operates.

NOTE

Avoid setting the compression too high, as the higher average output level that results may lead to feedback.

⇒ Continue to next page

Mono channels
 1–24 (MGP32X)
 1–16 (MGP24X)

Stereo channels
 25–32 (MGP32X)
 17–24 (MGP24X)

* ⑥–⑩ are for CH29/
 30, CH31/32 {CH21/
 22, CH23/24} only.

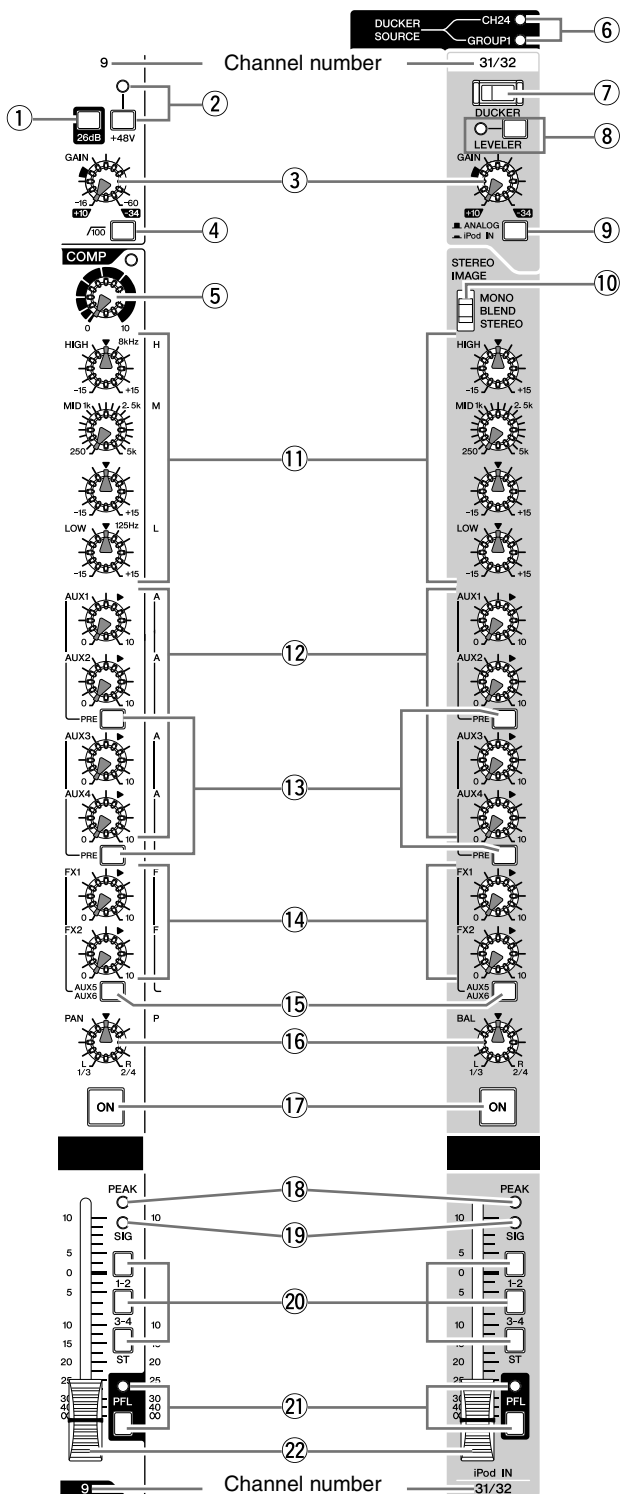

⑥ **DUCKER SOURCE indicator**

The indicator of the selected input source (CH24 {CH16} or GROUP1) comes on. The input source can be selected on the display (page 37).

⑦ **DUCKER switch**

Turning this switch on () lowers the volume of the stereo channel automatically when a signal exceeding a certain level is input to the input source (CH24 {CH16} or GROUP1). When the switch is turned on, the switch's lamp comes on.

⑧ **LEVELER switch and indicator**

Turning this switch on () allows the volume to be adjusted automatically to a certain level, when the actual sound output level differs for each song. The indicator is on when the switch is on.

⑨ **Input select switch**

Selects the input signal source. If this switch is set to ANALOG (), the jacks for CH29/30 and 31/32 {CH21/22, 23/24} will be the input source. If this switch is set to USB IN () or iPod IN (), the signal from an USB device or iPod/iPhone will be the input source. The signal from an USB device will be input to CH29/30 {21/22}, while the signal from an iPod/iPhone will be input to CH31/32 {23/24}.

NOTE

The GAIN knobs do not affect the volume of your iPod/iPhone. To adjust the pre-channel-fader signal volume, refer to page 36.

⑩ **STEREO IMAGE switch**

Selects the type of output signal for the input stereo signal.

- **MONO** : Mono signal
- **BLEND** : Stereo signal in which left and right inputs are mixed at a certain percentage for a more natural stereo image, and in which the pan is controlled.
- **STEREO** : Stereo signal (original, as is)

⑪ **Equalizer knobs (HIGH, MID, and LOW)**

This three-band equalizer changes the tone of the high, mid, and low frequency bands. Turning the knob to the right boosts the corresponding frequency band, while turning to the left attenuates the band. Setting the knob to the “▼” position produces a flat response in the corresponding band. The upper knob sets the center frequency for the mid range, while the lower knob sets the amount of attenuation or boost (counterclockwise/clockwise) for the range. For the CH25/26 and CH27/28 {CH17/18 and CH19/20}, the attenuation/boost can only be set at a fixed 2.5kHz center frequency. The following table shows the EQ type, frequency, and cut/boost range for each of the three bands.

Band	Type	Frequency	Cut/Boost range
HIGH	Shelving	8kHz	±15dB
MID	Peaking	2.5kHz*	
LOW	Shelving	125Hz	

* The MID frequency can be adjusted from 250Hz to 5kHz. The MID frequency is 2.5kHz when the MID frequency control is set at the center position.



⑫ AUX knobs (1-4)

These knobs adjust the channel's signal levels into AUX buses 1 to 4. Each knob controls the signal into the corresponding AUX bus. On stereo channels, the LINE L (odd) and LINE R (even) input signals are mixed before moving into the AUX bus. These knobs should generally be set close to the "▼" (nominal) position.

NOTE

- To enable use of AUX5 and AUX6, you must turn on () the AUX5/AUX6 switch (⑮).
- For AUX1 to AUX4, you use the PRE switch (⑬) to select whether the pre-fader or post-fader signal is sent to the bus. For AUX5 and AUX6, only the post-fader signal can be sent.

⑬ PRE switch

Selects whether the pre-fader or the post-fader signal is fed to the corresponding pair of AUX 1-4 buses. AUX1 and 2 and also AUX3 and 4 should be paired. The upper PRE switch controls the signal to AUX1 and AUX2; the lower switch controls the signal to AUX3 and AUX4. If the switch is on (), the mixer feeds the pre-fader signal to the corresponding buses. If off (), the mixer feeds the post-fader signal.



⑭ FX (effect) knobs (1, 2)

These knobs adjust the channel's post-fader signal levels into FX buses 1 and 2. On stereo channels, the LINE L (odd) and LINE R (even) input signals are mixed before moving into the FX bus. These knobs should generally be set close to the "▼" (nominal) position.

NOTE

If the AUX5/AUX6 switch is on, these knobs adjust the output to the AUX5 and AUX6 buses.

⑮ AUX5, AUX6 switch



Selects whether the channel's post-fader signal is sent to AUX buses 5 and 6 or FX buses 1 and 2. If the switch is on (), the signal goes to AUX5 and 6 buses; if off (), the signal goes to the FX buses.

**⑯ PAN knob (Mono channels)
BAL knob (Stereo channels)**

These knobs set the stereo pan position and determine the volume balance between left and right. When the channels are panned hard left or hard right, sound is heard from only the hard-panned channel.

The PAN knob determines each mono signal's pan positioning between left and right, while the BAL knob determines the stereo channel's volume balance between left and right.

⑰ ON switches

Turning this switch on () sends that channel's signal to the buses. When the switch is turned on, the switch's lamp comes on. If you turn the switch off (), all of the signal sent to the buses such as AUX and GROUP buses is cut off.

NOTE

- The ON switch does not affect the operation of the PFL switch (⑳). You can monitor the channel's pre-fader signal through the PHONES jack even when the ON switch is off.
- To reduce noise, turn all unused channels off.

⑱ PEAK indicator

Lights red when the channel's post-equalizer signal level reaches 3 dB before clipping.

⑲ SIG (Signal) indicator

Lights green when a signal is being input to the channel.

⑳ Bus assign switches

These switches determine the bus(es) to which each channel's signal is sent. Press the switch in () to output the signal to the corresponding bus.

- **Switches 1-2, 3-4:** Assign the channel's signal to the GROUP 1 to 4 buses.
- **ST switch:** Assigns the channel's signal to the STEREO L and R buses.

NOTE

To send the signal to each bus, engage the ON switch (⑰).

㉑ PFL (Pre-Fader Listen) switch and indicator

When the PFL switch is turned on () the indicator comes on and the channel pre-fader signal is output to the MONITOR OUT and PHONES jacks for monitoring.

㉒ Channel fader

Adjusts the output level of the input channel signal. Use these faders to adjust the balance between the various channels.

NOTE

To reduce noise, set the fader sliders for any unused channels all the way down.

● Mono Channel

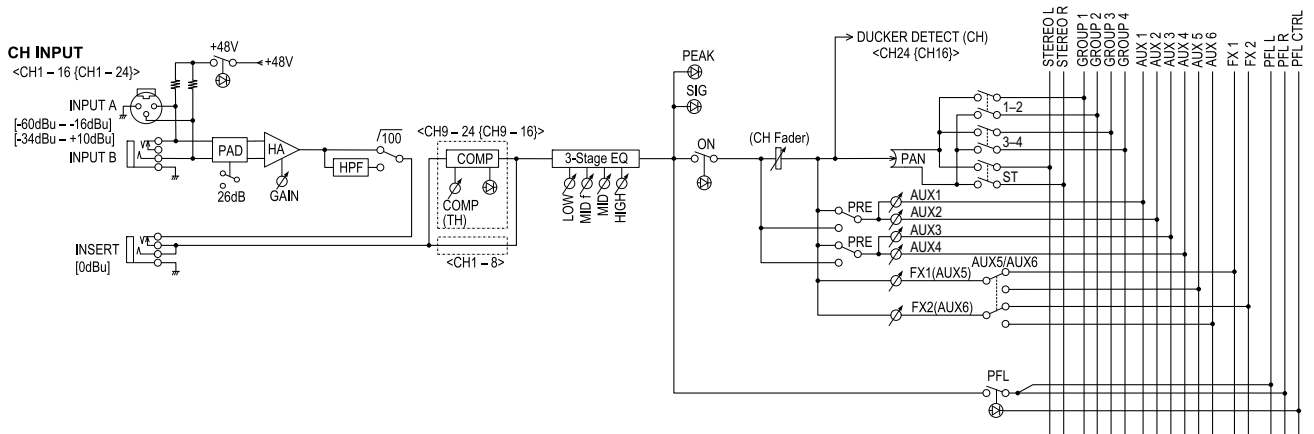

● Stereo Channel

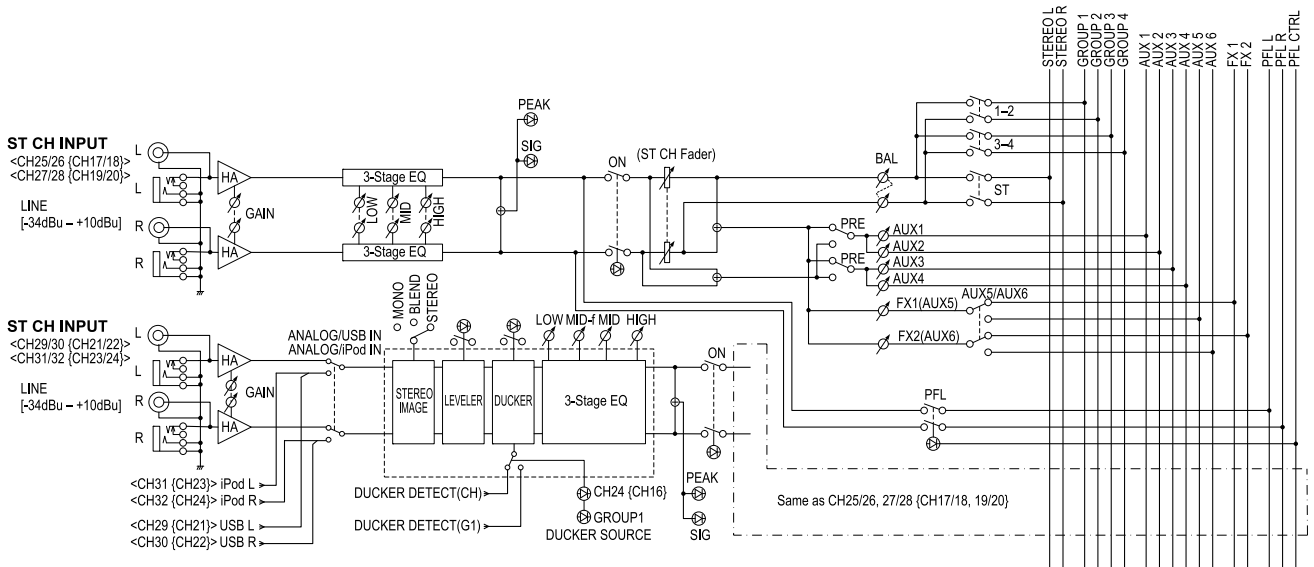

Master control block

USB device recorder section

With this section you can connect a USB device to record and play back music. (page 33)

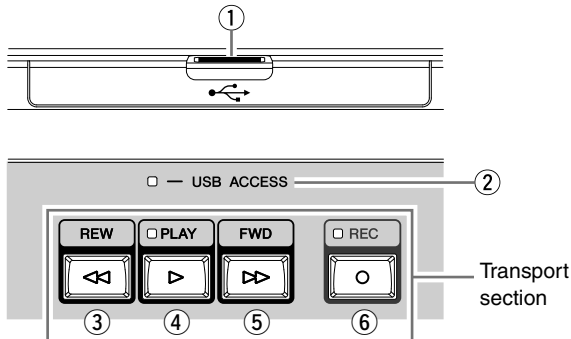

① USB IN connector

Connects the USB device.

② USB ACCESS indicator

Lights while the unit accesses the USB device.

● Capacity and format of the USB device

Up to 64GB of the capacity for the USB device is guaranteed by Yamaha. (However, Yamaha cannot guarantee operation for all the USB devices). The supported file system is FAT32. The maximum size of one file is 2GB.

NOTICE

- While the unit is accessing data (such as during recording, playing back, and saving operations), do NOT remove the USB device from the USB IN connector, and do NOT turn off the unit. Doing so may damage the USB device or corrupt the data on either or both the unit and the USB device.
- Make sure that you insert the USB device all the way in the correct orientation or upside down. Avoid inserting with excessive force.

■ Transport section

③ REW button

Press to move to the previous song. Holding down this button while playing back rewinds the song.

④ PLAY button and indicator

Press to alternately start/pause playback of the song. The indicator lights during playback, and flashes while paused.

⑤ FWD button

Press to move to the next song. Holding down this button while playing back forwards the song. Pressing this button while recording stops the current recording and begins recording a new file.

⑥ REC button and indicator

Press to start/stop recording. The indicator lights while recording.

iPod/iPhone section

This section lets you connect an iPod/iPhone to play back a song (page 36) and charge the iPod/iPhone. The unit charges the iPod/iPhone while it is connected to and recognized by the unit.

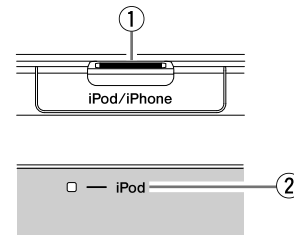

① iPod/iPhone IN connector

Use an USB cable to connect an iPod/iPhone.

② iPod indicator

Lights when the unit is accessing an iPod/iPhone.

⚠ CAUTION

- Use the genuine Apple Dock Connector USB Cable for the iPod/iPhone connection.
- When connecting to an iPod/iPhone, allow at least 6 seconds to pass between turning the mixer on and off and plugging or unplugging the USB cable.
- Please do not use a USB hub.
- The unit's iPod/iPhone IN connector is dedicated to iPod/iPhone use only. Please do not connect other USB devices.

NOTE

If you connect an iPhone, incoming calls or emails may cause a notification sound to be output. In order to prevent this, we recommend setting the iPhone's Airplane mode to "on."

Display section

This section is for setting and operating the display. Refer to pages 24-25 for details.

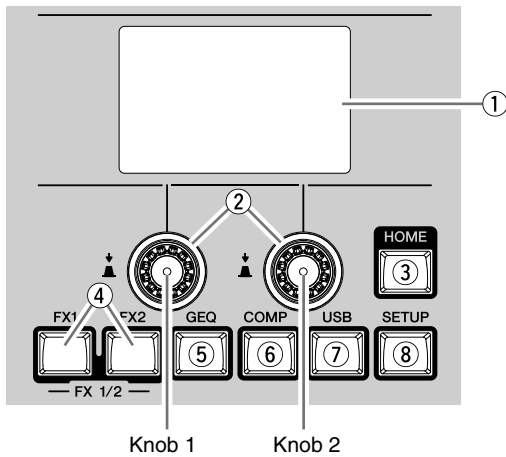

① Display

Indicates the various messages and settings related to the currently selected operation or function.

② Knob 1, Knob 2

Selects/sets the functions and parameters appearing on the display. Rotate Knob 1 to operate the functions on the lower left side of the display, and Knob 2 for the functions on the lower right side of the display.

③ HOME button

Calls up the display to view the status of the functions. This button does not determine or change the parameter.

④ FX1 and FX2 buttons

Call up the display to switch the programs of FX1 (effect1) and FX2 (effect2) and to adjust their parameters.

⑤ GEQ button

Calls up the display to set the Graphic equalizer (GEQ).

⑥ COMP button

Calls up the display to set the compressor.

⑦ USB button

Calls up the display to record and play back with the USB device.

⑧ SETUP button

Calls up the display to adjust the contrast of the display, and to set the ducker and the leveler.

Meter section

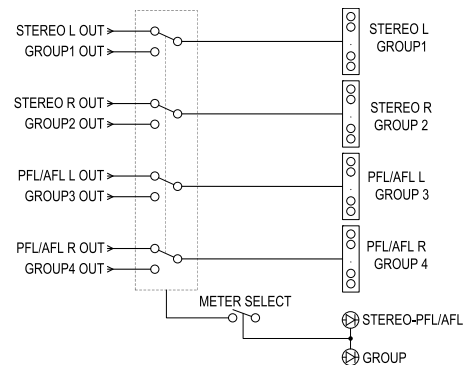

Use these meters to view various signal levels: the levels to the STEREO OUT L/R jacks, the PFL and AFL levels, and the levels to the GROUP OUT 1-4 jacks. The PFL or AFL signals indicated by these meters can be monitored through the MONITOR OUT jacks and the PHONES jack.

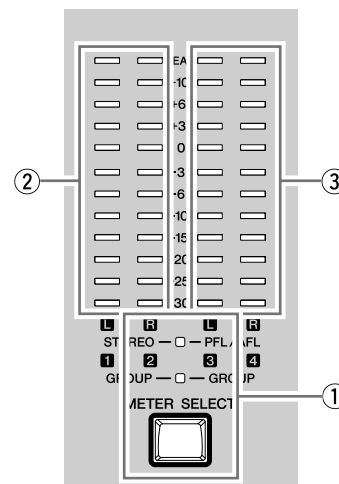

① METER SELECT button and indicator

Switches the display of the level meter to the output signal level of the STEREO OUT L/R and the PHONES jacks, or of the GROUP OUT 1-4 jacks. The indicators for the selected signals come on.

② STEREO level meter

Shows the signal level output to the STEREO OUT L/R jacks or the GROUP OUT 1 and 2 jacks, respectively. The "0" position corresponds to the standard level. The PEAK indicator lights red when the level hits the clipping point.

③ PFL/AFL level meter

Shows the signal level output to the PHONES jack or the GROUP OUT 3 and 4 jacks, respectively. The "0" position corresponds to the standard level. The PEAK indicator lights red when the level hits the clipping point.

NOTE

The PFL signal has display priority over the AFL signal when an input channel's PFL switch is on.

FX RTN (effect return) section

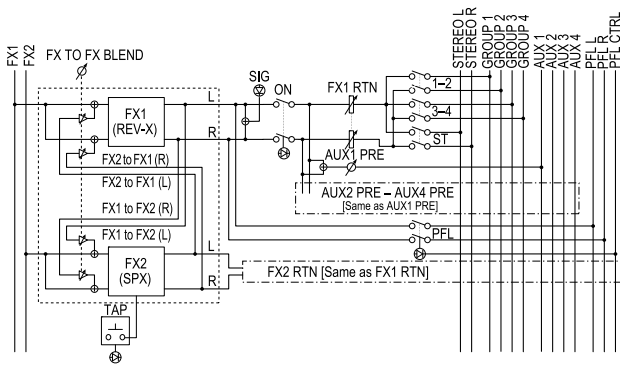

This section sets the effect returns (FX1 and FX2) on/off, and determines the level of the effect signal and to which bus the signal is sent.

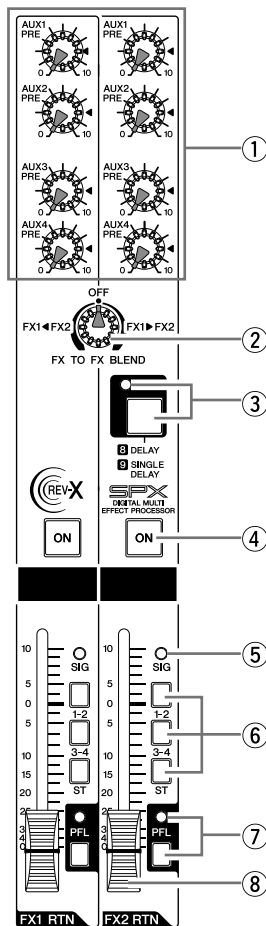

① AUX (PRE) knobs (1-4)

These knobs adjust the level of the effect sent to the AUX1 to AUX4 buses.

② FX TO FX BLEND knob

Sends the signal from FX1 to FX2 and from FX2 to FX1. Rotate this knob from the center “OFF” position to the right to adjust the send level from FX1 to FX2, and to the left to adjust the send level from FX2 to FX1. Only the pre-fader signal can be sent.

③ TAP button and indicator

This feature lets you set the delay time for FX2 by tapping on the button. This feature only works when the effect type for FX2 is set to “**8** DELAY” or “**9** SINGLE DELAY.” To set the delay time, tap on the button at the appropriate interval. The average interval at which you tap the button will be calculated, and that value will be set for the delay time. Continue tapping as necessary until you get the timing right.

The average interval will be set (the average of a, b, and c)

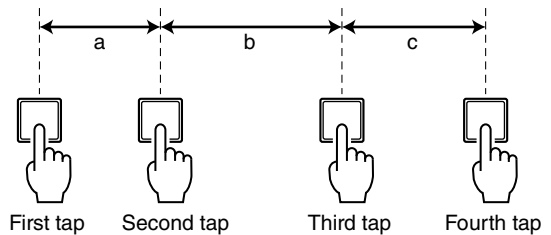

The TAP indicator flashes in sync with the delay time when **8** DELAY or **9** SINGLE DELAY is selected.

NOTE

- Adjust the average interval within range of the variable delay time.
- See page 44 for the range of the variable delay time.

④ ON switch

Turn this switch on () to enable the FX RTN (effect return). When the switch is turned on, the switch’s lamp comes on.

⑤ SIG (Signal) indicator

Lights when an effect signal is input into the channel.

⑥ Bus assign switches

These switches determine the bus(es) to which the signal of the internal digital effects is sent. Press the switch in () to output the signal to the corresponding buses.

- **Switches 1-2, 3-4:** Assign to the GROUP1 to GROUP4 buses.
- **ST switch:** Assigns to the STEREO L/R bus.

⑦ PFL (Pre-Fader Listen) switch and indicator

When the PFL switch is turned on (), the indicator will light and the pre-FX (1, 2) RTN-fader signal is output to the MONITOR OUT and PHONES jacks for monitoring.

⑧ FX RTN (effect return) faders (1, 2)

These adjust the level of the effect sent from the internal effect to the GROUP1 to GROUP4 buses, and STEREO L/R buses.

SEND MASTER section

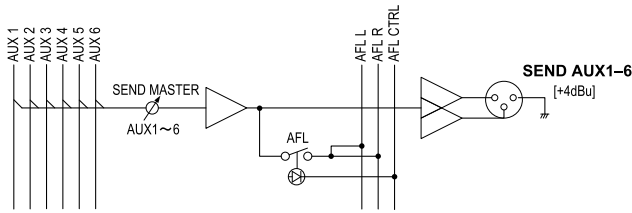

This section adjusts the levels and controls the output of signals from the six AUX buses. Each of these signals outputs to the corresponding SEND (AUX1-AUX6) jack respectively.

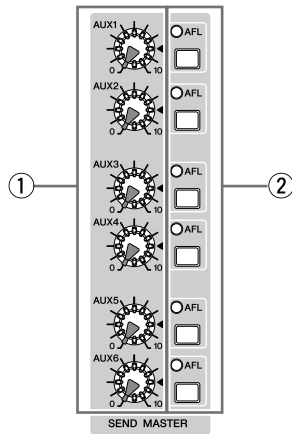

① AUX knobs (1-6)

These knobs adjust the level of the signal from the indicated AUX1 to AUX6 buses into the corresponding SEND (AUX1 to AUX6) jacks. The “▼” position of the knob is the nominal level (0 dB).

② AFL (After-Fader Listen) switch and indicator

Turning this switch on monitors the post-AUX1 to AUX6 knob (①) signals that output to the MONITOR OUT and PHONES jacks for monitoring.

NOTE

- The PFL signal has priority when both the PFL switch and AFL switch are on. To monitor the post-fader signal, make sure to turn off all PFL switches.
- If the PFL (preferred) is enabled, the AFL indicator does not light, even if the AFL switch is pressed.

MATRIX section

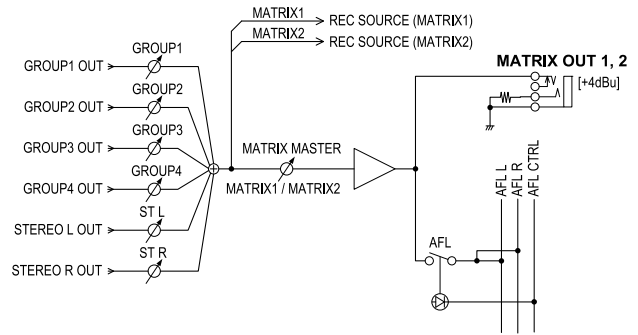

This section adjusts the levels and controls the output of signals to the MATRIX OUT jacks from GROUP OUT and STEREO OUT. The signals from the MATRIX 1 and 2 buses are sent to the MATRIX 1 and 2 jacks respectively.

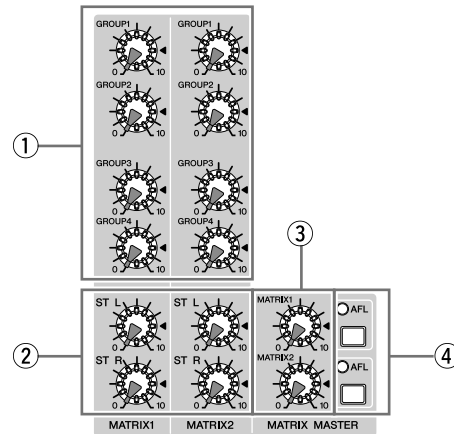

① GROUP knobs (1-4)

These knobs adjust the level of the signals sent from GROUP OUT 1-4 buses to the MATRIX OUT jacks.

② STEREO knobs (L, R)

These knobs adjust the level of the signals sent from STEREO OUT L/R buses to the MATRIX OUT jacks.

③ MATRIX master knobs (1, 2)

These knobs adjust the overall level of the signal output to the MATRIX OUT jacks.

NOTE

The “▼” positions of the knobs for (①), (②), and (③) indicate the nominal level (0 dB).

④ AFL switch and indicator

When the AFL switch is on, the indicator will light and the signal after the MATRIX master knob is output to the PHONES and MONITOR OUT jacks for monitoring.

USB IN/iPod IN section

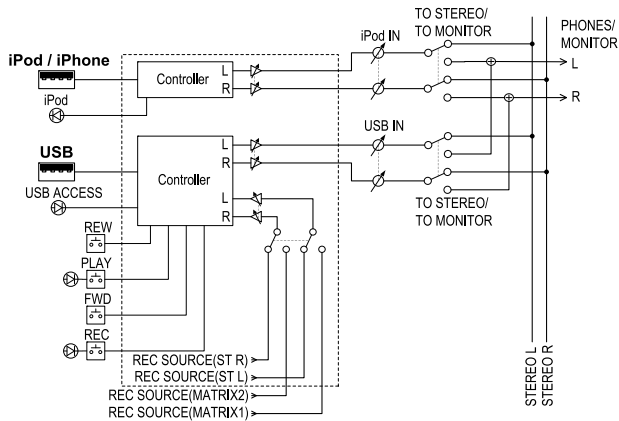

This section determines the destination of the signal output from the connected USB device or iPod/iPhone, and adjusts the signal level.

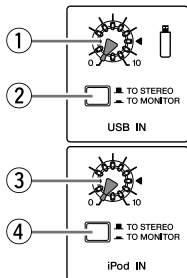

① USB IN knob

Adjusts the playback level from the connected USB device.

② TO STEREO/TO MONITOR switch

Determines the destination of the signal output from the connected USB device.

- **TO STEREO ([])**: Sends to the STEREO L/R bus.
- **TO MONITOR ([])**: Sends to the MONITOR OUT jacks and PHONES jack.

③ iPod IN knob

Adjusts the playback level from the connected iPod/iPhone.

④ TO STEREO/TO MONITOR switch

Determines the destination of the signal output from the connected iPod/iPhone.

- **TO STEREO ([])**: Sends to the STEREO L/R bus.
- **TO MONITOR ([])**: Sends to the MONITOR OUT jacks and PHONES jack.

NOTE

CH29/30, 31/32 {CH21/22,23/24} can be selected as the destinations of the signal input from the connected USB device or iPod/iPhone (pages 34, 36).

PHONES/MONITOR section

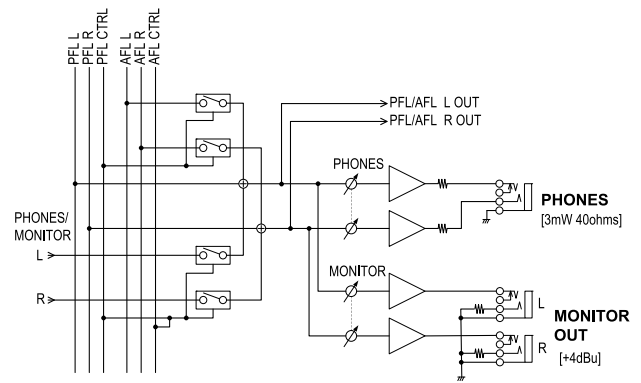

You connect a pair of headphones and adjust the output signal level to the PHONES and MONITOR OUT jacks.

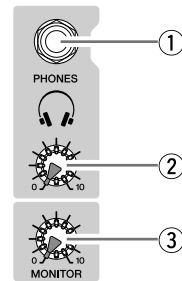

① PHONES jack

Connect a pair of headphones to this TRS phone jack. The PHONES jack outputs the same signal as the MONITOR OUT jacks.

② PHONES knob

Adjusts the level of the signal output to the PHONES jack.

③ MONITOR knob

Adjusts the level of the signal output to the MONITOR OUT jacks.

NOTE

If you want to monitor the output signal from the STEREO, MONO or GROUP bus, turn on the AFL switch of each respective bus.

TALKBACK section

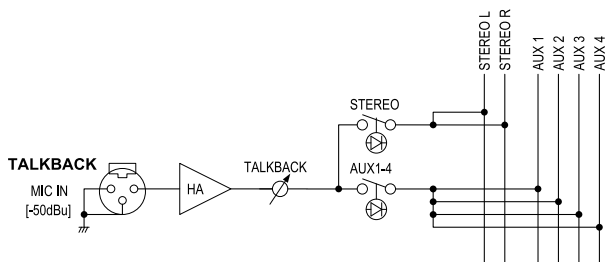

Use the talkback function to send instructions mainly from the operator to musicians and studio staff. This section adjusts the level of the microphone signal received from the TALKBACK MIC IN jack, and determines the bus to be output.

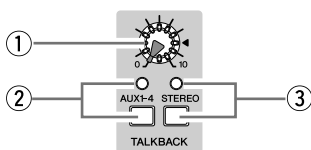

① Talkback knob

Adjusts the talkback level.

② AUX1-4 switch and indicator

Turning this switch on sends the signal from the TALKBACK MIC IN jack to the AUX1 to AUX4 buses.

③ STEREO switch and indicator

Turning this switch on sends the signal from the TALKBACK MIC IN jack to the STEREO L/R bus.

GROUP section

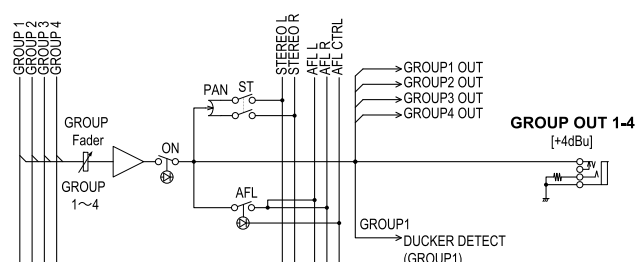

This section adjusts the level and controls the flow of the signals from the four GROUP buses. While the signal from each GROUP bus is always sent to the corresponding GROUP OUT jack, you are also free to use the ST and AFL switches to selectively send these groups to the STEREO and AFL buses.

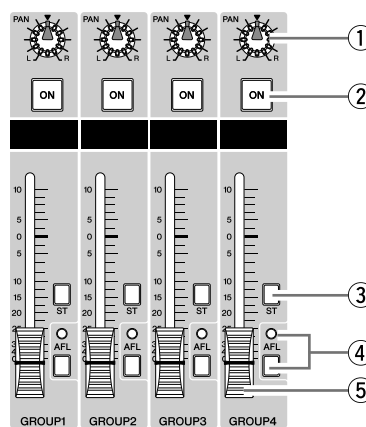

① PAN knob

Determines how the signal from the GROUP 1-4 buses is positioned on the STEREO L/R buses when turning the ON switch (2) on.

② ON switch

Turning this switch on enables the GROUP fader. When the switch is turned on, the switch's lamp comes on.

③ ST (Stereo) switch

Turning this switch on sends the signal adjusted with the GROUP fader (5) via the PAN knob (1) to the STEREO L/R bus.

④ AFL (After-Fader Listen) switch and indicator

When the AFL switch is on, the indicator will light and the signal after the GROUP fader (5) is output to the MONITOR OUT and PHONES jacks for monitoring.

⑤ GROUP faders (1-4)

These adjust the level of the signal sent to the corresponding GROUP OUT 1-4 jacks.

NOTE

- The PFL signal has priority when both the PFL switch and AFL switch are on. To monitor the post-fader signal, make sure to turn off all PFL switches.
- If the PFL (preferred) is enabled, the AFL indicator does not light, even if the AFL switch is pressed.

MONO master section

This section adjusts the level of the mixed monaural output from the STEREO bus.

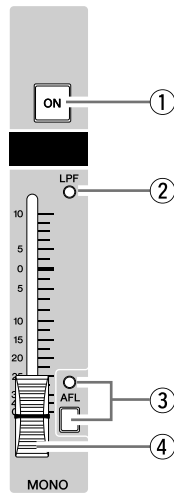

- ① **ON switch**
Turning this switch on enables the MONO master fader. When the switch is turned on, the switch's lamp comes on.
- ② **LPF indicator**
Lights when setting "LPF ON" to "ON" in the SETUP screen on the display.
- ③ **AFL switch and indicator**
When the AFL switch is turned on, the indicator will light and the signal after the MONO master fader is output to the MONITOR OUT and PHONES jacks for monitoring. To monitor the post-fader signal, make sure to turn off all PFL switches.
- ④ **MONO master fader**
Adjusts the level of the signal output in mono from the STEREO bus to the MONO OUT jack.

STEREO master section

This section adjusts the level of the main output from the STEREO bus.

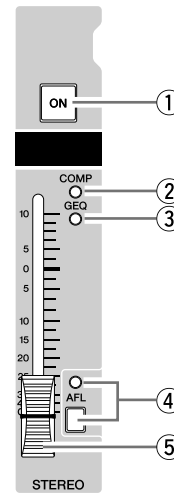

- ① **ON switch**
Turning this switch on enables the STEREO master fader. When the switch is turned on, the switch's lamp comes on.
- ② **COMP (Compressor) indicator**
Lights when setting the COMP to "ON" in the COMP screen on the display.
- ③ **GEQ indicator**
Lights when setting the GEQ ON to "ON" in the GEQ screen on the display.
- ④ **AFL switch and indicator**
When the AFL switch is on, the indicator will light and the signal after the STEREO master fader is output to the MONITOR OUT and PHONES jacks for monitoring. To monitor the post-fader signal, make sure to turn off all PFL switches.
- ⑤ **STEREO master fader**
Adjusts the level of the signal output from the STEREO bus to the STEREO OUT jack.

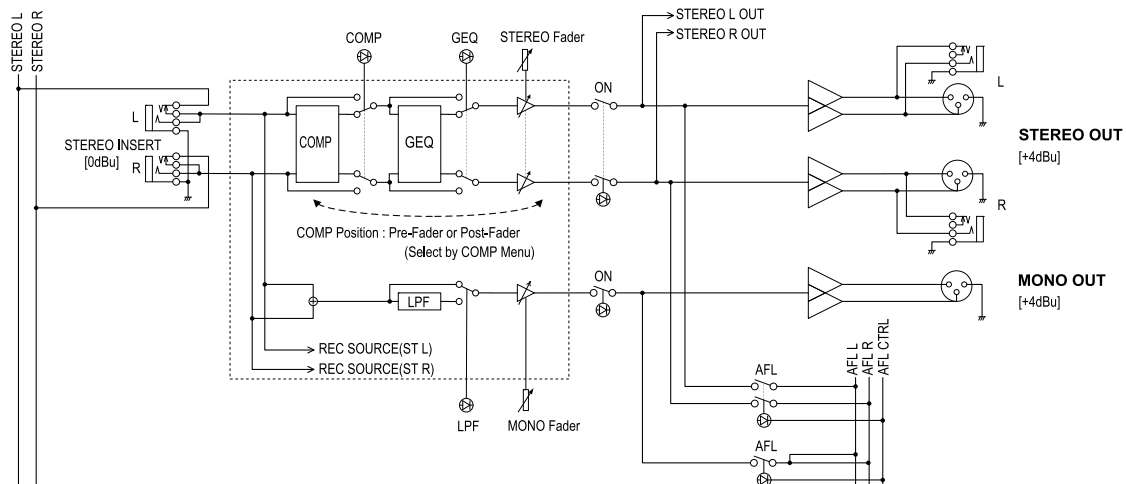

Rear input/output block

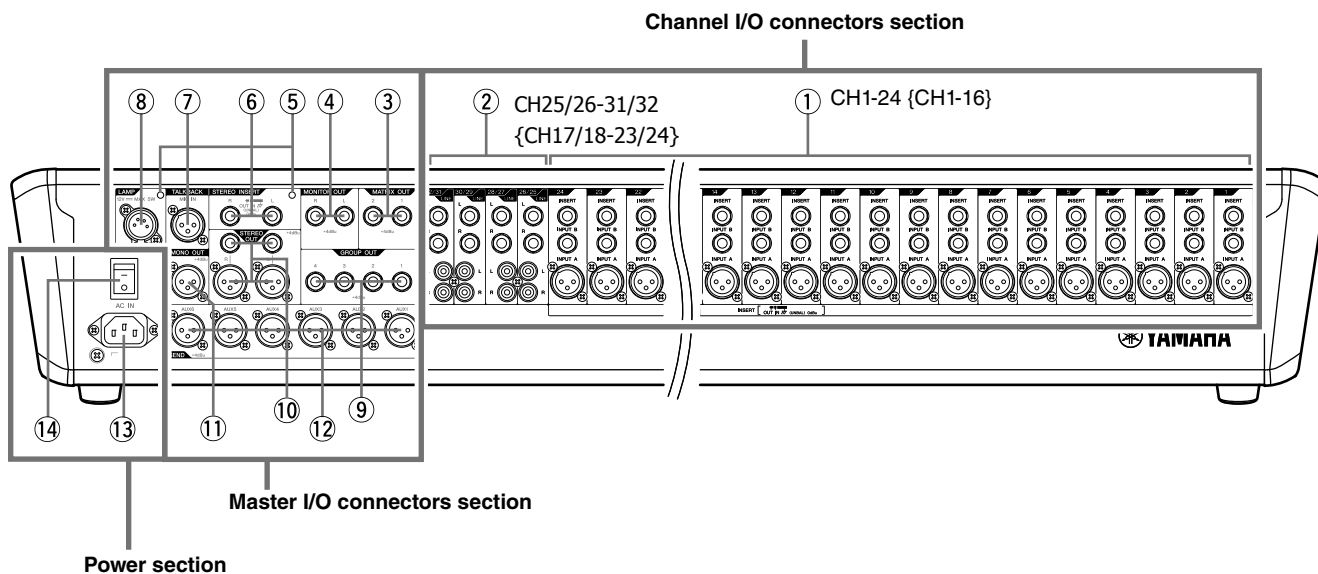

Channel I/O connectors section

① Mono inputs

- **INPUT A:** These are balanced XLR-3-31 type input jacks (1: Ground; 2: Hot; 3: Cold).
- **INPUT B:** These are TRS phone-jack type balanced inputs. You can connect either balanced or unbalanced phone plugs to these jacks.

NOTE

On any given channel, you may use either an XLR or phone jack, but not both.

- **INSERT:** These are unbalanced TRS (tip=send/out; ring=return/in; sleeve=ground) phone-type bidirectional jacks. You can use these jacks to connect channels to devices such as graphic equalizers, compressors, and noise filters.

NOTE

Connection to an INSERT jack requires a special insertion cable as illustrated below. Use a separately-sold Yamaha insertion cable (YIC025/050/070).

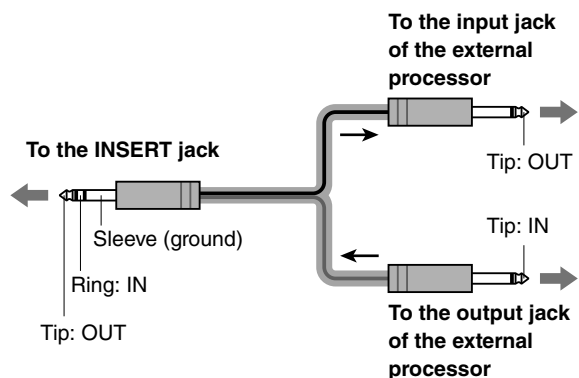

② Stereo inputs

- **LINE:** These are stereo input jacks that connect line-level instruments, such as a CD player. These are unbalanced phone-jack and RCA pin-jack line inputs.

NOTE

On any given channel, you may use either a phone or RCA pin jack, but not both.

Master I/O connectors section

③ MATRIX OUT (1, 2)

These are impedance-balanced (*) TRS phone jacks. These jacks output the signal adjusted by the knobs in the MATRIX section.

* Impedance balanced

Since the hot and cold terminals of impedance balanced output jacks have the same impedance, these output jacks are less affected by induced noise.

④ MONITOR OUT (L, R)

These are impedance-balanced(*) TRS phone output jacks that you connect to your monitor system. These jacks output the signal before or after the faders for the various buses. The PFL and AFL indicators in each section indicate which signal is being output.

NOTE

The PFL switch has priority when both the PFL switch and AFL switch are on. To monitor the post-fader signal, make sure to turn off all PFL switches.

⑤ Screw holes

These are screw holes for mounting a stand for various devices (87mm between the holes). Stands and screws are not included with this product, and must be provided by the user. Use M5 screws that are no longer than 20mm.

⑥ STEREO INSERT (L, R)

These are unbalanced TRS (tip=send/out; ring=return/in; sleeve=ground) bidirectional jacks. You can use these jacks to connect a graphic equalizer or other signal processor. Connecting an INSERT jack requires a special insertion cable. Refer to the NOTE for INSERT in “Mono inputs” (page 22).

⑦ TALKBACK MIC IN

This is an XLR-3-31 type unbalanced input jack for connecting a talkback microphone.

⑧ LAMP

This is an XLR-4-31 connector that supplies power to a separately sold gooseneck lamp (the Yamaha LA1L is recommended).

NOTE

If you connect a lamp with different connectors or you short-circuit it by mistake, the protective circuit that powers off only the LAMP power supply will be triggered. To recover the LAMP power supply, turn the unit off, and wait for about 10 seconds before turning it on again.

⑨ GROUP OUT (1-4)

These impedance-balanced (*) TRS jacks output the GROUP 1-4 signals. Use these jacks to connect to the inputs of a multi-track recorder, external mixer, or similar device.

⑩ STEREO OUT (L, R)

These are balanced XLR and TRS output jacks that output the mixed stereo signal. They output the signal adjusted by the STEREO master fader. Connect these jacks to the power amplifier that drive your main speakers.

⑪ MONO OUT

This is a balanced XLR-3-32 output jack that outputs the signal adjusted by the MONO master fader. This outputs a mono signal of the mixed stereo bus (L/R). Connect to a subwoofer speaker or an expanded SR system.

⑫ SEND (AUX1-AUX6)

These are balanced XLR-3-32 output jacks (1: Ground; 2: Hot; 3: Cold). These jacks output the signals from the AUX1 – AUX6 buses, respectively. Use these jacks to connect to an effects processor or monitor system, for example.

Power section**⑬ AC IN connector**

Connect the included power cord here. First, connect the power cord to the MGP unit, and then plug it into an AC outlet.

⑭ Power switch

Turns power to the unit ON or OFF. Press the switch to the “—” position to turn on the power. Press the switch to the “○” position to turn off the power.

⚠ CAUTION

- **Rapidly turning the unit ON and OFF in succession can cause it to malfunction. After turning the unit OFF, wait for about 6 seconds before turning it ON again.**
- **Even when the power switch is turned off, electricity is still flowing to the product at the minimum level. When you are not using the product for a long time, make sure to unplug the power cord from the wall AC outlet.**

Basic Operations and Display

This chapter explains the basic operations about how to view the display and operate the screen.

Viewing the display

The display indicates the various parameters for operating the unit.

■ Setting screen

Press a button in the display section to display the desired screen.

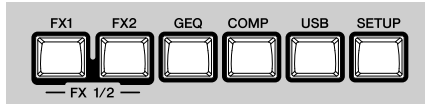

Example: Screen when pressing the COMP button

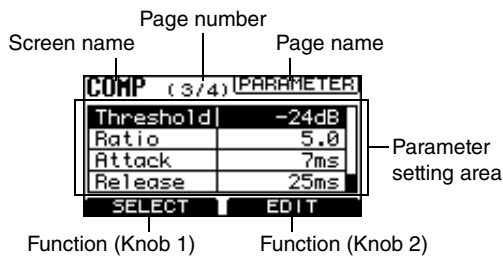

■ HOME screen

This screen appears when pressing the HOME button.

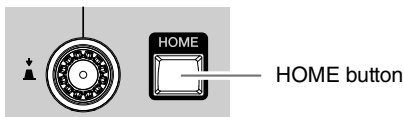

This screen lists the status of the settings. You cannot change the settings in the HOME screen.

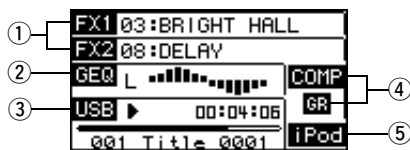

① FX1, FX2 status

Displays the status of the FX1 RTN (or FX2 RTN) channel when on (highlighted) or off (normal display), and the selected program.

Example

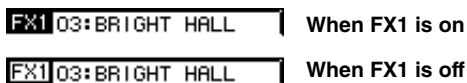

② GEQ status

Displays the status of the GEQ when on (highlighted) or off (normal display), and the graphics. Pressing the HOME button switches the L and R displays.

③ USB status

Displays the inserted (highlighted) or disconnected (normal display) status of a USB device, the playback status (▶), the playback/recording time, and the title (up to 16 characters) of an audio file.

④ COMP status

Displays the status of the COMP (compressor) when on (highlighted) or off (normal display). Also, the GR (Gain reduction) indicator displays the status of the signal when compressed (highlighted) or not compressed (normal display).

⑤ iPod status

Displays the connected (highlighted) or disconnected (normal display) status of the iPod/iPhone.

■ Dialog screen

These screens appear when you need to confirm the operation you just performed or when a problem has occurred.

● Confirmation screen

This screen appears when confirmation is required. Press Knob 2 to execute the operation, and press Knob 1 to cancel it.

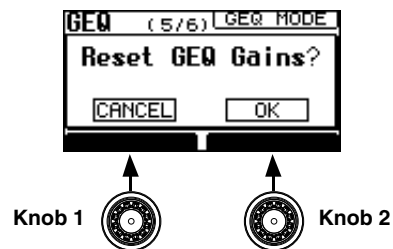

● Message screens

These screens will display the following messages according to the level of warning when a problem is detected in the unit.

Example: WARNING screen



• MESSAGE

This screen appears when the operation is not executed because the conditions are not right, or when user memory is initialized.

• WARNING

This screen appears when an inappropriate device is connected to the USB connector, or when an abnormal exit occurs during an operation.

• ERROR

This screen appears when a problem is detected in the MGP32X/MGP24X internal connection.

Press Knob 2 to close the screen. In the case of MESSAGE, the screen will automatically close after a few seconds without pressing Knob 2.

Operations of the screen

■ Switching the pages

The setting screen for each button consists of multiple pages. Press each button (FX1, GEQ, SETUP, etc.) in the display section repeatedly if necessary to select the desired page.

Example: Pages when pressing the SETUP button

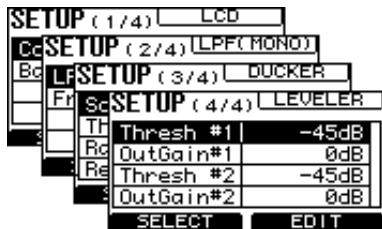

■ Setting or changing the value

Generally, rotate Knob 1 to select the desired parameter, and then rotate Knob 2 to change or set the corresponding parameter value.

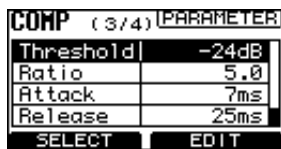

■ Displaying or selecting a list

The FX1 (or FX2) screen displays the effect program list, and the USB screen displays the title list of songs. Rotate or press Knob 1 on the top page (first page) of each screen to call up the list. Rotate Knob 1 to select the desired program/title, and then press Knob 1 to actually select it.



■ Exiting the screen

To return to the HOME screen from the current screen, press the HOME button.

■ Adjusting the legibility of the display

1. Press the SETUP button repeatedly if necessary until the (1/4) LCD page appears.



2. Rotate Knob 1 to select “Contrast,” and then rotate Knob 2 to adjust the legibility of the display.

You can adjust the Contrast over a range of 0 to 10.

NOTE

You can adjust the legibility by rotating Knob 2 while holding down the HOME button.

■ Adjusting the brightness of the display backlight

1. Press the SETUP button repeatedly if necessary until the (1/4) LCD page appears.



2. Rotate Knob 1 to select “Backlight,” and then rotate Knob 2 to adjust the brightness.

You can adjust the Backlight over a range of 0 to 3.

Using Effects (FX)

The MGP32X/MGP24X features two built-in effects; FX1 and FX2. FX1 has REV-X reverb (8 types), while FX2 has SPX multi effects (a total of 16 types, including reverb, delay, echo). The effects give you a wide range of tools to further enhance your mixes.

Applying effects

1. Press the FX1 (or FX2) button located below the display repeatedly if necessary until the (1/2) MAIN page appears.

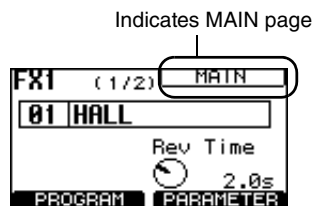

2. Rotate or press Knob 1 to display the program list.

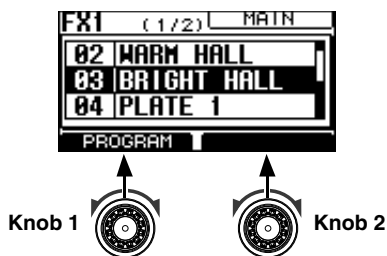

NOTE

For details on effect programs, refer to the Appendix (page 43).

3. Rotate Knob 1 to select the desired program, and then press Knob 1 to actually call it up.
The selected program will be called up.
4. Turn on the ON switch of the input channel, and then rotate the channel's FX1 (or FX2) knob to send the signal to FX1 RTN (or FX2 RTN).

5. Raise the input channel fader to the "0" position.

6. Turn on the ON switch of the FX1 RTN (or FX2 RTN) channel.

7. Raise the FX1 RTN (or FX2 RTN) fader to the "0" position.

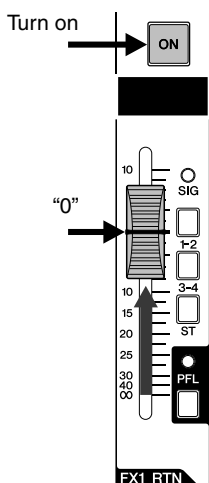

8. Rotate Knob 2 to adjust the effect depth.

The value on the lower right side of the screen will change on the display.



NOTE

If 06 VOCAL ECHO, 07 KARAOKE ECHO, 08 DELAY, or 09 SINGLE DELAY is selected for the FX2 program, you can adjust the Delay in finer units of 0.1ms by simultaneously holding down Knob 2 and rotating it. This function also applies to the (2/2) PARAMETER page and the page that both FX1 and FX2 screens are displayed on.

9. Use the FX1 RTN (or FX2 RTN) fader to adjust the overall effect depth.

Detailed effect settings

1. Press the FX1 (or FX2) button below the display repeatedly if necessary until the (2/2) PARAMETER page appears.

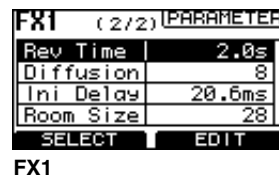

2. Rotate Knob 1 to select the desired parameter, and then rotate Knob 2 to set the value.

FX1 lets you make the following parameter settings.

- **Rev Time:** Length of reverb time
- **Diffusion:** Right and left diffusions
- **Ini Delay:** Initial delay before reverb begins
- **Room Size:** Size of room

NOTE

For FX2, the effect parameters depend on the effect type. For details about each parameter, refer to the Appendix (pages 44-45).

Applying two effects simultaneously

Two effects can be applied simultaneously by sending the signals from FX2 to FX1 (or from FX1 to FX2). This is especially useful for applying reverb to the delay sound. This section shows you how to send the signal from FX2 to FX1.

1. Press the FX2 button below the display to display the (1/2) MAIN page.
2. Rotate or press Knob 1 to display the program list.
3. Rotate Knob 1 to select "08 DELAY" or "09 SIGNAL DELAY"; and then press Knob 1 to actually call it up.

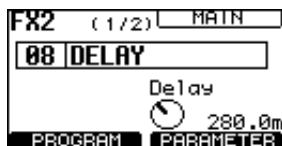

4. Turn on the ON switch of the input channel, and then rotate the FX2 knob to send the signal to FX2 RTN.

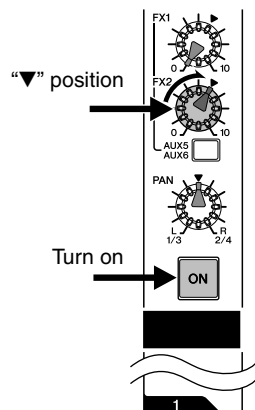

5. Rotate the FX TO FX BLEND knob fully counter-clockwise.

The signal from FX2 will be sent to FX1.

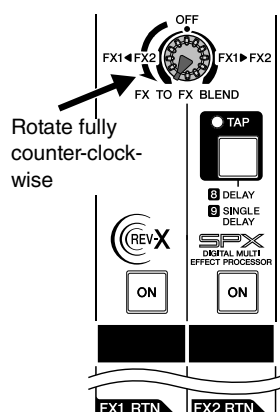

6. Turn on the ON switch of the FX1 RTN channel, and then raise the FX1 RTN fader to adjust the effect depth.

Displaying FX1 and FX2 together

The selected programs and parameters of FX1 and FX2 can conveniently be displayed on one screen together. You can select the program and operate the parameter on the same screen.

1. Press the FX1 button and the FX2 button together.

Both FX1 and FX2 screens appear on one screen.

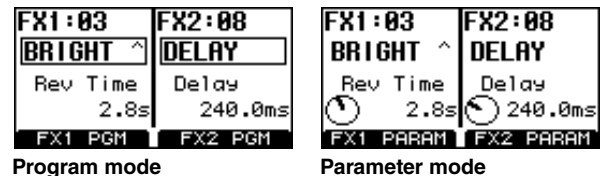

NOTE

To switch the program mode and the parameter mode, press the FX1 or FX2 button.

●Selecting a program

1. Press the FX1 (or FX2) button repeatedly if necessary to call up the Program mode display (indicated by "PGM" at the bottom).

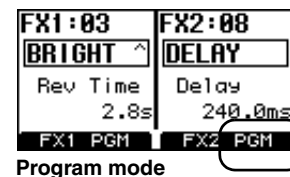

2. Rotate or press Knob 1 for FX1, and Knob 2 for FX2.

The program list appears.

3. Rotate Knob 1 for FX1 or Knob 2 for FX2 to select the desired program, and then press each knob respectively to actually call it up.

The program will be called up.

●Selecting a parameter

1. Press the FX1 (or FX2) button repeatedly if necessary to call up the Parameter mode display (indicated by "PARAM" at the bottom).

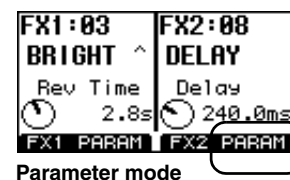

2. Rotate Knob 1 (for FX1) or Knob 2 (for FX2) to adjust the parameter.

●Exiting the screen

Press the HOME, GEQ, COMP, USB, or SETUP button in the display section to switch to the corresponding screen.

Using Graphic EQ

About the graphic EQ (GEQ)

Graphic EQ processing is inserted into the STEREO bus (L/R). You can select the 14bandGEQ or the Flex9GEQ. The Flex9GEQ lets you adjust the gain by selecting up to nine bands from the 31 frequency bands.

Setting the GEQ

In the initial state, the GEQ is set to ON, and the “Type” of GEQ is set to 14bandGEQ.

1. Press the GEQ button below the display repeatedly if necessary until the GEQ MODE page appears.

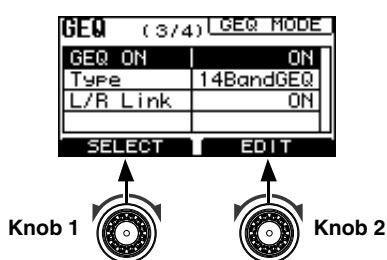

2. Rotate Knob 1 to select “GEQ ON,” and then rotate Knob 2 to set to “ON.”
3. Rotate Knob 1 to select “Type,” and then rotate Knob 2 to set to “14BandGEQ” or “Flex9GEQ.”
If you select a different type from the current type setting, the parameter value flashes.
4. Press Knob 2 while the parameter value is flashing.

The screen prompts you to reset the gain because the parameters of 14BandGEQ and Flex9GEQ are not compatible.



5. Press Knob 2 to select “OK,” or Knob 1 to cancel.
The GEQ type will be changed.

■ Setting the frequency and gain

1. Press the GEQ button below the display repeatedly if necessary until the EDIT page appears.

If the “L/R Link” is set to “ON,” the “EDIT L/R” page appears. If the “L/R Link” is set to “OFF,” the “EDIT Lch” page or “EDIT Rch” page appears.

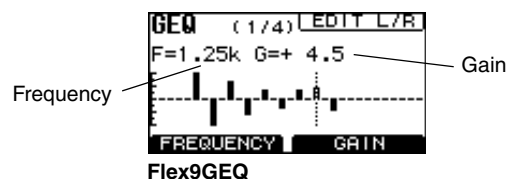
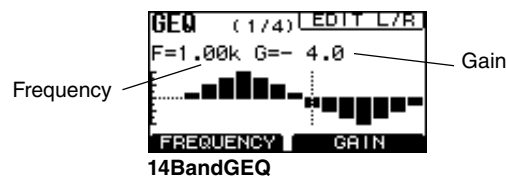

2. Rotate Knob 1 to move the cursor to the desired frequency.

“F” in the screen indicates frequency. For example, F=1.25k indicates a frequency of 1.25kHz.

3. Rotate Knob 2 to determine the frequency gain.

“G” in the screen indicates gain. For example, G=4.5 indicates a gain of +4.5dB.

After you make the settings, it is convenient to save these settings to one of the user programs (page 30).

● Resetting the selected frequency gain

Press and hold Knob 1 for at least two seconds.

● Resetting the gain of all frequencies

1. Press Knob 1 and Knob 2 together.

The confirmation message “Reset GEQ Gains?” appears.

2. Press Knob 2 to select “OK,” or Knob 1 to cancel.

All frequency gains will be reset.

■ Linking the right and left stereo signals

You can edit the right and left channels together by linking the right and left stereo signals. In the initial state, the link is set to "ON." Disabling the link allows you to set parameters separately for the right and left channels.

1. Press the GEQ button below the display repeatedly if necessary until the GEQ MODE page appears.

2. Rotate Knob 1 to select "L/R Link," and then rotate Knob 2 to set to "ON."

The parameter value flashes.

3. Press Knob 2 while the parameter value is flashing.

The screen prompts you to reset the gain.



4. Press Knob 2 again to select "OK," or Knob 1 to cancel.

The gain will be reset, and the link setting is executed. The indication on the upper right side of the GEQ EDIT and the GEQ SWEEP screens changes to "L/R."

● Clearing the link setting

1. In step 2 above, change the parameter value from "ON" to "OFF."
2. While the parameter value is flashing, press Knob 2.
The screen prompts you to confirm "Break Link?"
3. Press Knob 2 again to select "OK," or Knob 1 to cancel.
The link is disabled.

Finding and removing feedback

Using the offset gain lets you check the feedback point in advance, and feedback can be reduced by correcting the gain with GEQ.

1. Press the GEQ button below the display repeatedly if necessary until the SWEEP page appears.

If the "L/R Link" is set to "ON," the "SWEEP L/R" page appears. If the "L/R Link" is set to "OFF," the "SWEEP Lch" page or "SWEEP Rch" page appears.

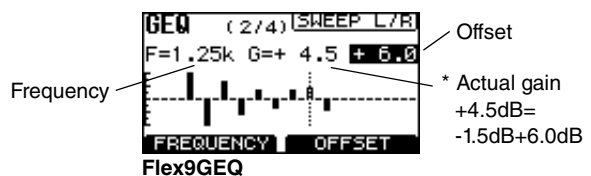
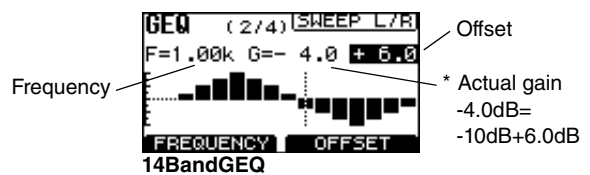

$$* \text{ Actual gain} = \text{parameter (setting) value} + \text{offset}$$

2. Rotate Knob 2 to specify the rough offset value.

Raise the gain temporarily by using the offset setting to create a situation with no feedback margin, and find the feedback point.

3. Rotate Knob 1 slowly to find the feedback point.

You will start to hear feedback when the frequency reaches the feedback point.

4. When the feedback point is found, rotate Knob 2 to lower the offset to a minus value in order to reduce feedback.

5. When the final adjustment has been made, press Knob 2.

Offset will be added only to the setting value of the adjusted frequency.

6. Repeat steps 2 -5 as necessary to adjust the GEQ settings.

Calling up/saving the GEQ program

Eight user programs are available that you can freely edit and save on the MGP32X/MGP24X.

■ Calling up the program

1. Press the GEQ button below the display repeatedly if necessary until the PROGRAM page appears.



2. Rotate or press Knob 1 to call up the program list.



3. Rotate Knob 1 to select the desired program and press Knob 1 to actually call it up.



■ Saving the program

● Overwriting the selected user program

1. Press and hold Knob 2 for at least two seconds while the user program is selected.

The screen prompts you to save the program.



2. Press Knob 2 to select "OK," or Knob 1 to cancel.

The program will be overwritten.

NOTE

You can also cancel the operation by pressing the GEQ button.

● Overwriting another user program

1. Rotate or press Knob 1 to call up the program list.



2. Rotate Knob 1 to select the user program of the destination for saving, then press and hold Knob 2 for at least two seconds.

The screen prompts you to save the program.

3. Press Knob 2 to select "OK," or Knob 1 to cancel.

The program will be overwritten.

NOTE

You can also cancel the operation by pressing the GEQ button.

Using the Compressor

About the master compressor

The MGP32X/MGP24X features two master compressors: Comp and Multiband. The Comp type has a simple single band, while the Multiband type has three separate bands. The master compressor controls peak level by applying the compressor to the stereo L/R bus, and raises the overall sound level. There are three preset programs installed, and you can save up to five user programs as desired.

Specifying the compressor settings

1. Press the COMP button below the display repeatedly if necessary until the (1/4) MODE page appears.

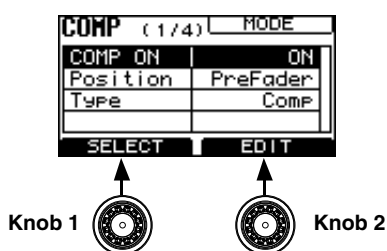

2. Rotate Knob 1 to select "COMP ON," and rotate Knob 2 to set to "ON."
3. Rotate Knob 1 to select "Position" (of the insert), and rotate Knob 2 to set to "PostFader" or "PreFader."
4. Rotate Knob 1 to select "Type," and rotate Knob 2 to set to "Comp" (single band) or "Multiband."

If you select a different setting from the current setting, the parameter value flashes.

5. Press Knob 2 while the parameter value is flashing.

The screen prompts you to change the compressor type.

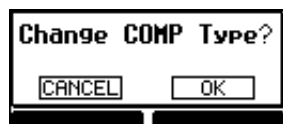

6. Press Knob 2 to select "OK," or Knob 1 to cancel.

The type is changed.

Specifying the threshold

1. Press the COMP button below the display repeatedly if necessary until the (2/4) THRESHOLD page appears.
2. Rotate Knob 1 to specify the threshold, while checking the gain reduction meter on the right side of the screen to determine the compressor depth.

If Multiband is selected, the thresholds at H (High), M (Mid) and L (Low) are linked.

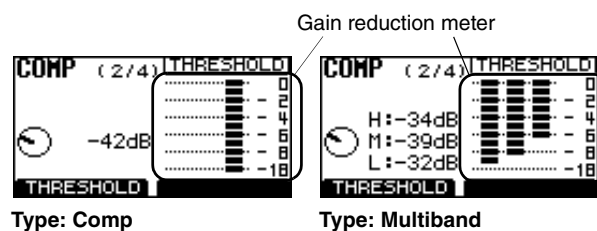

Adjusting the compressor settings

1. Press the COMP button below the display repeatedly if necessary until the (3/4) PARAMETER page appears.

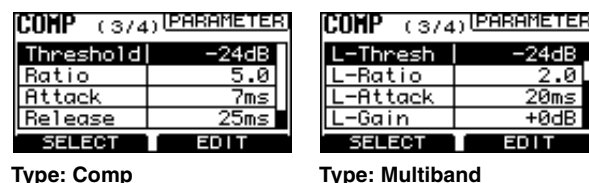

2. Rotate Knob 1 to select the desired parameter, and rotate Knob 2 to specify the parameter value.

NOTE

For details about the parameters, refer to the Appendix (page 45).

Calling up/saving the compressor program

1. Press the COMP button below the display repeatedly if necessary until the (4/4) PROGRAM page appears.
2. Rotate or press Knob 1 to display the program list.
3. Rotate Knob 1 to select the desired program, and press Knob 1 again to call it up.

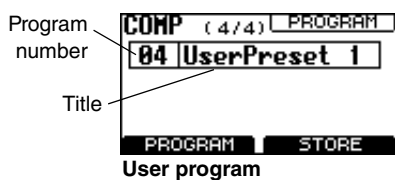
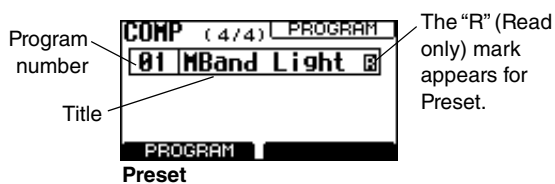

● Saving the user program

4. While the user program is called up, press and hold Knob 2 for at least two seconds.

The screen prompts you to save the program.



5. Press Knob 2 to select "OK," or Knob 1 to cancel.

The current setting will be overwritten as a user program.

NOTE

- You can also cancel saving by pressing the COMP button.
- Use the MGP Editor (page 6) to change the name of the user program as desired.

Recording/Playing back

About USB device recording/playing back

The MGP32X/MGP24X features an internal USB device recorder function that lets you record the output from the STEREO bus L/R or MATRIX bus 1 and 2 to a conventional USB storage device as an audio file. It also lets you playback a song saved to a USB device via an assigned STEREO bus, MONITOR OUT, or channels 29/30 {21/22}.

●Signal flow of the USB device recorder†

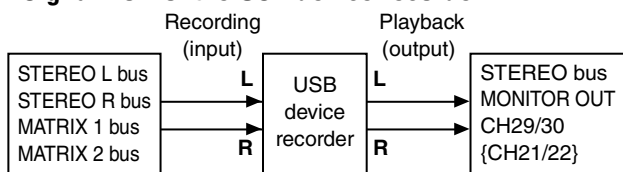

NOTE

- Recording and playback cannot be done simultaneously.
- The signal being recorded cannot be input to the input channel.

●About the USB device

You can use commercially-available USB flash drives, HDD (hard disc drive) or SSD (solid-state drive), which support USB mass storage device class.

NOTICE

- While data is being accessed, such as when recording, playing, or saving a file, you must not disconnect the USB device from the USB IN connector or power-off the MGP32X/MGP24X. Doing so may damage your USB device, or damage the data in the MGP32X/MGP24X and/or in the USB device.
- Connect the USB device firmly and securely to the USB IN connector. Make sure to check the direction and sides of the USB device and do not force the USB device into the connector.
- Since high transmission speed is required for recording in WAV recording format, we recommend that you use HDD or SSD.

●USB device capacity

Operation of USB devices with capacities of up to 64GB has been verified.

NOTICE

This does not necessarily guarantee the operation of all USB devices. It is recommended that you check the operation of the USB device beforehand.

●USB device format

FAT32 format is supported. The maximum size for one file is 2GB.

●Supported file formats

- Recording: WAV, MP3
- Playback: WAV, MP3, AAC

●Available recording time (with 2GB USB flash drive)

- MP3 128kbps: Approx. 35 hours
- MP3 192kbps: Approx. 23 hours
- MP3 256kbps: Approx. 17 hours
- MP3 320kbps: Approx. 14 hours
- WAV: Approx. 3 hours

Recording to a USB device

1. Connect a USB device with sufficient free capacity to the USB IN connector.
2. Press the USB button below the display repeatedly if necessary until the (3/3) PARAMETER page appears.

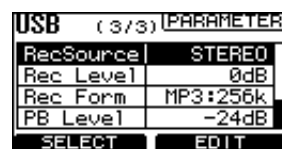

3. Rotate Knob 1 to select “RecSource,” and then rotate Knob 2 to select the “STEREO” bus or the “MATRIX1/2” bus.
4. To select the recording format, proceed as follows.
 - ① Rotate Knob 1 to select “Rec Form,” and then rotate Knob 2 to select one of the following recording formats: “MP3:128k,” “MP3:192k,” “MP3:256k,” or “WAV.”

If you select a different type from the current one, the parameter value flashes.

- ② Press Knob 2 while the parameter value is flashing.

The screen prompts you to change the recording format.

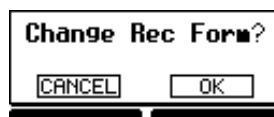

When MP3:128k, MP3:192k, MP3:256k, or MP3:320k is selected:

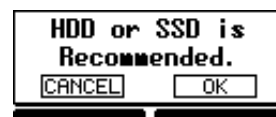

When WAV is selected, HDD or SSD is recommended for recording.

- ③ Press Knob 2 to select “OK,” or Knob 1 to cancel.

The format is changed.

⇒ Continue to next page

5. To adjust the recording level, proceed as follows.

- ① Press the USB button below the display repeatedly if necessary until the (2/3) REC LEVEL page appears.

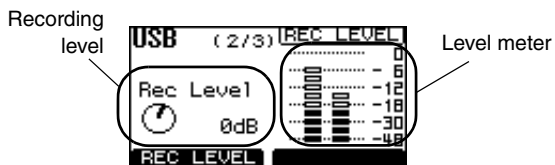

- ② While playing back the sound source to be recorded, rotate Knob 1 to adjust the recording level while checking the level meter.

The recording level can be adjusted between -48dB and +24dB. Each level of the REC OUT L/R will be displayed on the level meter.

6. Press the REC button.

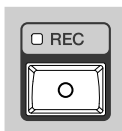

The REC indicator flashes briefly, indicating preparation for recording. Once the indicator lights steadily, you can begin recording.

7. To stop recording, press the REC button again.

The screen prompts you to stop recording.



8. Press Knob 2 to select "OK," or Knob 1 to cancel.

The recording stops and an audio file is created. The audio file will be saved in the "MGP_REC" folder.

NOTE

AUTO REC function: If you press the FWD button while recording, the current recording is completed and recording to a new file starts.

9. To audition the recorded content, proceed as follows.

- ① Press the USB button below the display repeatedly if necessary until the (1/3) PLAYER page appears.

- ② Rotate or press Knob 1 to display the title list.

The recorded song is saved with the name "Untitled X" (X is a number) in the "MGP_REC" folder.

NOTE

- Information such as a title or artist cannot be edited on the unit. You will need to import the file to a computer and edit it there.
- Since a calendar function is not installed in the unit, the date of the file is fixed.

- ③ Rotate Knob 1 to select the recorded song, and then press Knob 1 to confirm it.

Playback starts.

Playing back songs from a USB device

1. Connect a USB device containing audio files to the USB IN connector.

The USB ACCESS indicator lights while the USB device is being accessed by the unit.

2. Specify the output assignment for the playback.

■ To output to the STEREO bus

Set the TO STEREO/TO MONITOR switch in the USB IN section to "TO STEREO" ().

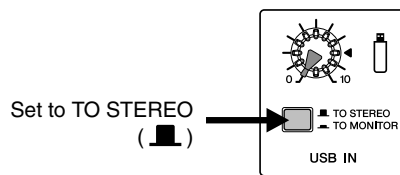

■ To output to MONITOR OUT

Set the TO STEREO/TO MONITOR switch in the USB IN section to "TO MONITOR" ().

■ To output to channels 29/30 {21/22}

Set the input select switch for the channel 29/30 {21/22} to "USB IN" ().

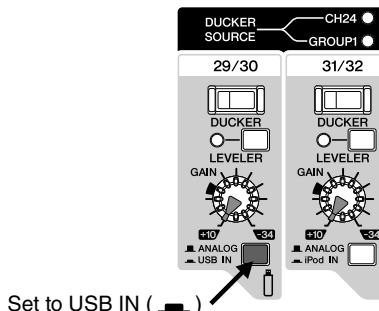

NOTE

Do not use both the STEREO/MONITOR level control (USB IN knob) and the level control for channels 29/30 {21/22} at the same time. Raising both may cause unnatural flanging in the sound.

3. Press the USB button below the display repeatedly if necessary until the (1/3) PLAYER page appears.

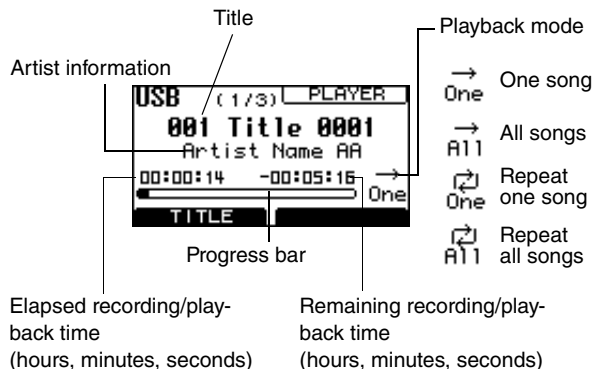

NOTE

- The file name is indicated if there is no title or artist information of the song. For WAV format files, the file name is indicated since there is no title or artist information in the file.
- The title, artist information, and file name support half-size alphabet and numbers only. Other characters are converted into "□."
- "Recording..." appears at the location of the title while recording.

4. Press the REW or FWD button in the transport section to select the playback song, and then press the PLAY button.

Playback starts.

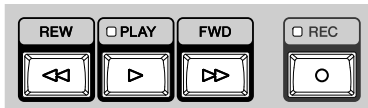

5. Adjust the sound volume of the song.

■ When outputting to the STEREO bus or MONITOR OUT

Rotate the USB IN knob to adjust the volume.

■ When outputting to the channel 29/30 {21/22}

Use the channel fader to adjust the volume.

NOTE

- Gain may be high for an audio file encoded from the audio CD. As necessary, adjust the gain as follows: press the USB button → call up the "(3/3) PARAMETER" screen → select and adjust "PB Level."
- Avoid adjusting both outputs at the same time because of the delay of the signal path.



6. Press the PLAY button again.

Playback is paused.

●Playing back a song from the title list

1. Press the USB button below the display repeatedly if necessary until the USB (1/3) PLAYER page appears.

2. Rotate or press Knob 1 to display the title list.

- When you select the line of the folder () and press Knob 1, the content of the folder appears.
- Selecting the line of () and pressing Knob 1 moves to the upper folder.

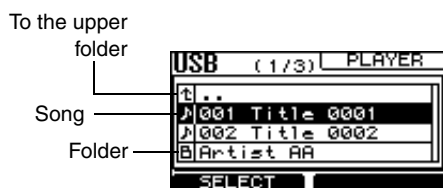
**NOTE**

The title list supports half-size alphabet and numbers only. Other characters are converted into "□."

3. Rotate Knob 1 to select a song (), and then press Knob 1.

Playback starts.

■ Pausing, fast forwarding, or fast rewinding the playback

Use the buttons in the transport section.

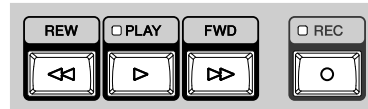

●Pausing

Press the PLAY button during playback to pause playback. Pressing the PLAY button a second time resumes playback from the stopped point. While paused, the indicator flashes.

●Fast forwarding/rewinding

Holding down the REW or FWD button for at least one second starts fast forwarding or rewinding while a song is playing. Releasing the button resumes normal playback from that point.

●Navigating through a song

Press the REW or FWD button to move a song.

- Pressing the REW button during playback moves to the beginning of the current song or moves to the beginning of the previous song and starts playback, depending on the song playback position.
- Pressing the FWD button during playback moves to the beginning of the next song and then starts playback.
- Pressing the REW or FWD button while the song is stopped or paused moves to the previous or next song.

Playing back songs from an iPod/iPhone

Connecting your iPod or iPhone to the unit lets you play back the song.

NOTE

You cannot make recordings to an iPod or iPhone.

1. Use a USB cable to connect your iPod (or iPhone) to the iPod/iPhone IN connector.

When the iPod or iPhone is connected to and recognized by the unit, the iPod indicator lights.

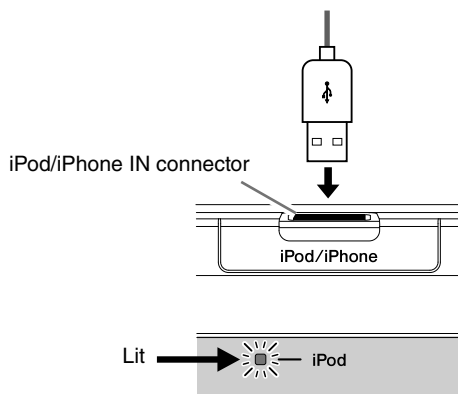

2. Specify the output assignment for playback.

■ To output to the STEREO bus

Set the TO STEREO/TO MONITOR switch in the iPod IN section to "TO STEREO" ().

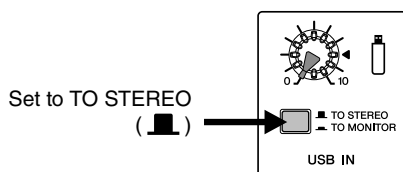

■ To output to MONITOR OUT

Set the TO STEREO/TO MONITOR switch in the iPod IN section to "TO MONITOR" ().

■ To output to channels 31/32 {23/24}

Set the input select switch for channels 31/32 {23/24} to "iPod IN" ().

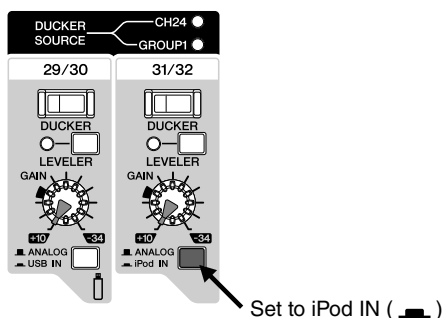

NOTE

Do not use both the STEREO/MONITOR level control (USB IN knob) and the level control for channels 31/32 {23/24} at the same time. Raising both may cause unnatural flanging in the sound.

3. Operate the iPod (or iPhone) to play back the desired song.

4. Adjust the volume of the song.

■ When outputting to the STEREO bus or to MONITOR OUT

Rotate the iPod IN knob to adjust the volume.

■ When outputting to channels 31/32 {23/24}

Use the channel fader to adjust the volume.

NOTE

Avoid adjusting both outputs at the same time because of the delay of the signal path.

5. Operate the iPod (or iPhone) to stop the song.

Playback stops.

Specifying the recording/playback settings

1. Press the USB button below the display repeatedly if necessary until the (3/3) PARAMETER page appears.

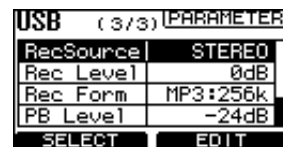

2. Rotate Knob 1 to select the desired parameter, and then rotate Knob 2 to set the parameter value.

Each parameter lets you make the following settings.

Parameter name	Content	Parameter value/range
RecSource	Selection of the recording signal source	STEREO, MATRIX1/2
Rec Level	Adjustment of the recording level	-48dB to +24dB
Rec Form	Selection of the recording format type	MP3:128k, 192k, 256k, 320k, WAV * "k" is an abbreviation for "kbps."
PB Level	Adjustment of playback level	-48dB to 0dB
PB Mode	Selection of playback mode	One, All, Repeat One, Repeat All
iPodLevel	Adjustment of the input level from the iPod or iPhone	-48dB to 0dB

NOTE

Since high transmission speed is required for recording in WAV format, recording songs to USB flash drives may not be possible. We recommend using HDD (hard disc drive) or SSD (solid-state drive) when recording songs.

If you use a USB flash drive for recording songs, MP3 recording formats such as MP3:128k, MP3:192k, MP3:256k, and MP3:320k are recommended.

Using Other Functions

Applying the Low Pass Filter (LPF)

A Low Pass Filter (LPF) can be applied to the signal output from the STEREO bus L/R to the MONO OUT connector. LPF is commonly used for subwoofer applications.

1. Press the **SETUP** button below the display repeatedly if necessary until the **SETUP (2/4) LPF (MONO)** page appears.

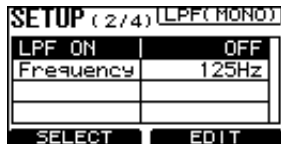

2. Rotate Knob 1 to select “LPF ON,” and then rotate Knob 2 to set it to “ON.”

The LPF indicator next to the MONO master fader comes on

3. Rotate Knob 1 to select “Frequency,” and then rotate Knob 2 to set the frequency.

Using the Ducker function

The Ducker function automatically lowers the level of background music to accommodate the voice of an announcer coming in on another channel.

● Ducker signal flow

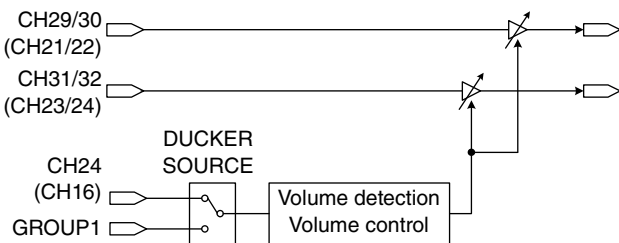

1. Connect a music player or device for playing background music.

Connect the device to CH29/30 or CH31/32 {CH21/22 or CH23/24}.

To connect the USB device or iPod/iPhone, set the input select switch to USB IN () or iPod IN () respectively.

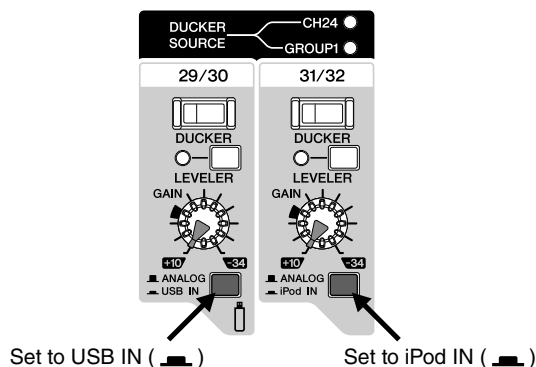

2. Turn on () the **DUCKER** switch of the channel to which the device is connected in step 1, and then rotate the **GAIN** knob to adjust the input level of the channel.

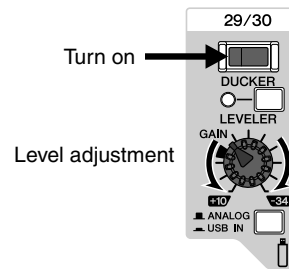

3. Connect a microphone to the input source channel.

For the MGP32X unit connect the microphone to CH24 and for the MGP24X unit connect the microphone to CH16, or assign the source channel to GROUP OUT 1.

4. Press the **SETUP** button below the display repeatedly if necessary until the (3/4) **DUCKER** page appears.

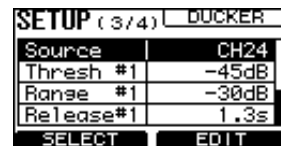

5. Confirm that “Source” is selected, and then rotate Knob 2 to set the input source to “CH24 {CH16}” or “GROUP1.”

If you automatically control the volume of background music via an independent microphone input, it is recommended that you set the input source to CH24 {CH16}. If you want to control the volume of background music via multiple microphones inputs, you should set the input source to “GROUP1.”

6. Adjust the input of the microphone to an appropriate level.

7. Turn on () the **ON** switch of the channel to which the microphone is connected in step 3, and then raise the channel fader to around “0” (nominal).

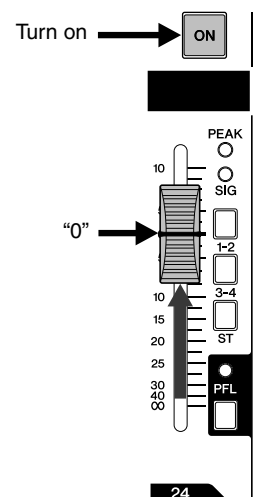

⇒ Continue to next page

- Play the background music, and listen to confirm that the sound volume automatically turns down when you speak into the microphone.

NOTE

The volume on the input source is detected after fader adjustment. It is affected by the setting of the ON switch and/or the channel fader.

■ **Making detailed Ducker settings**

- Press the SETUP button below the display repeatedly if necessary until the (3/4) DUCKER page appears.

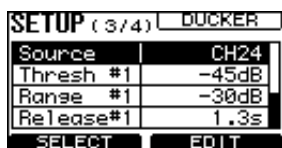

- Rotate Knob 1 to select the desired parameter, and then rotate Knob 2 to set the parameter value.

Each parameter lets you make the following settings.

- **Source:** Selection of the signal used as an input source
- **Thresh (Threshold):** Threshold level at which the Ducker is applied
- **Range:** The amount of attenuation while the Ducker is being applied
- **Release:** Time that elapses before the Ducker is disabled, after the input signal has lowered below the threshold level

“#1” in the parameter name indicates CH29/30 {CH21/22}, and “#2” indicates CH31/32 {CH23/24}.

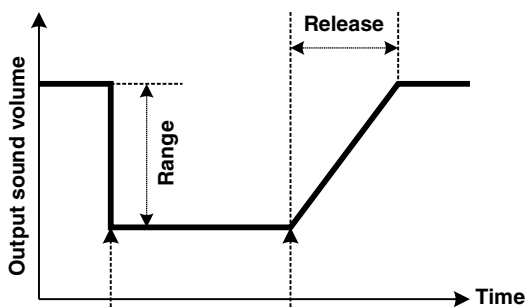

When the volume of the DUCKER SOURCE exceeds the threshold

When the volume of the DUCKER SOURCE drops below the threshold

NOTE

For details about the parameters, refer to the Appendix (page 45).

Using the Leveler function

The Leveler function automatically maintains a consistent sound volume, even when using sound sources that have different mastering levels.

- Connect a USB device or an audio player such as an iPod/iPhone to the unit.
- If you connect an audio player other than an iPod/iPhone, adjust the input level according to the softest part (lowest level) of the song.

Adjust the input level so that the PFL/AFL level meter indicator only occasionally rises above the “0” level while the PFL switch is on.

- If a USB device is connected, turn on () the LEVELER switch of CH29/30 {CH21/22}. If an iPod/iPhone is connected, turn on the LEVELER switch of CH31/32 {CH23/24}.

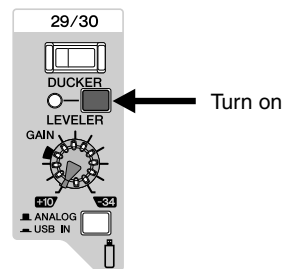

■ **Adjusting the Leveler settings**

- Press the SETUP button below the display repeatedly if necessary until the (4/4) LEVELER page appears.

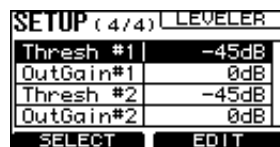

- Rotate Knob 1 to select the desired parameter, and then rotate Knob 2 to set the parameter value.

Each parameter lets you make the following settings.

- **Thresh (Threshold):** Threshold level at which the Leveler is applied
- **OutGain:** Output level of the Leveler

“#1” in the parameter name indicates CH29/30 {CH21/22}, and “#2” indicates CH31/32 {CH23/24}.

NOTE

For details about the parameters, refer to the Appendix (page 45).

Initializing the unit to the factory default settings (resetting user memory)

The MGP32X/MGP24X unit has a function to reset user memory by initializing the unit to the factory default settings. The parameter settings and user programs will be reset to the factory default settings.

NOTICE

When user memory is initialized, all the parameter settings and user programs in the current user memory will be overwritten with the factory default settings. Proceed with the following operation only if you are very sure you want to do this.

1. Make sure that the power of the unit is set to off.
2. Turn on the power switch while holding down both the FX1 and the SETUP buttons.

The following MESSAGE screen appears when initialization is complete. Hold down both the FX1 and SETUP buttons until the MESSAGE screen appears.





3. Press Knob 2 to close the screen, or wait until the MESSAGE screen automatically closes.

The display returns to the normal HOME screen.

NOTICE

Do not turn off the power while initialization is in progress.

Troubleshooting

<p>■ Power doesn't come on.</p>	<p><input type="checkbox"/> Is an independent power-supply unit such as a power generator, or a power strip with switch plugged into the mixer? Make sure that the power is turned on.</p>
<p>■ No sound.</p>	<p><input type="checkbox"/> Are microphones, external devices, and speakers connected correctly? <input type="checkbox"/> Is a Y-shaped cable used to connect the INSERT connector or an external device? <input type="checkbox"/> Are your cables connected properly, or are they shorted or faulty? <input type="checkbox"/> Are the channel GAIN knobs, channel faders, STEREO master fader and GROUP faders set to appropriate levels? <input type="checkbox"/> Are the bus assign switch and switches in the USB IN section and in the iPod IN section set properly?</p>
<p>■ No sound from the STEREO OUT jacks</p>	<p><input type="checkbox"/> Are the ON switch and ST switch of the channels you are using turned ON? <input type="checkbox"/> Is the ON switch of the STEREO master turned on?</p>
<p>■ No sound from the AUX1 to AUX6 jacks</p>	<p><input type="checkbox"/> Are the respective SEND MASTER knob, AUX1 to AUX6 knobs, FX1 and FX2 knobs of each channel set to appropriate levels?</p>
<p>■ No sound from the MONITOR OUT and/or PHONES jacks</p>	<p><input type="checkbox"/> Are the PFL switches for the channels that you are not using turned on? Make sure to turn off the PFL switch. <input type="checkbox"/> Is the AFL switch of the bus channel you want to monitor turned on?</p>
<p>■ No sound from the CH29/30, CH31/32 {CH21/22, CH23/24} jacks</p>	<p><input type="checkbox"/> Is the input select switch set to USB IN/iPod IN ()? Make sure to set the switch to ANALOG ().</p>
<p>■ Sound is faint, distorted, or noisy.</p>	<p><input type="checkbox"/> Are the channel GAIN knobs, channel faders, STEREO master fader and GROUP faders set to appropriate levels? <input type="checkbox"/> Is the 26dB switch turned on? Make sure to turn off the switch when a low-level source, such as a microphone, is input. <input type="checkbox"/> Is the output signal from the connected device set to an appropriate level? <input type="checkbox"/> Are you applying the effects and compressor at appropriate levels? You may have to lower the FX1, FX2 knobs, FX RTN fader, and COMP knob levels. <input type="checkbox"/> Are two different instruments connected to the XLR-type and phone jacks, or to the phone and RCA pin jacks on one channel? Make sure to connect to only one of these jacks on each channel. <input type="checkbox"/> Are microphones connected to the INPUT A input jacks? <input type="checkbox"/> If you are using condenser microphones, is the +48V switch turned ON? <input type="checkbox"/> If you are connecting a device which has a specified output level of +4dBu, turn on the 26dB (PAD) switch of the mono channels or use stereo channels. <input type="checkbox"/> (Stereo channel) Is the DUCKER switch turned on? When a signal is constantly input to CH24 {CH16} or the GROUP 1 bus, the sound becomes faint.</p>
<p>■ No effect is applied.</p>	<p><input type="checkbox"/> Check that the FX1 and FX2 knobs on each channel are adjusted correctly. <input type="checkbox"/> Check whether the ON button of the FX1 RTN and/or FX2 RTN channel is turned on. <input type="checkbox"/> Be sure that Knob 2, and the FX1 RTN and/or FX2 RTN faders are correctly adjusted. <input type="checkbox"/> Check that the switch for the desired bus in the FX1 RTN and/or FX2 RTN bus assign switches is turned on. <input type="checkbox"/> When an effects processing unit is connected to the SEND(AUX1 to AUX6) jacks, are the AUX1 to AUX6 knobs on the SEND MASTER set to appropriate levels?</p>
<p>■ I want spoken words to be heard more clearly.</p>	<p><input type="checkbox"/> Make sure that the $\sqrt{100}$ switch is turned ON. <input type="checkbox"/> Are the equalizers (HIGH, MID, and LOW knobs) on each channel adjusted appropriately?</p>
<p>■ I want to output a monitor signal for the mixer through speakers.</p>	<p><input type="checkbox"/> Connect a powered speaker to the MONITOR OUT jack. Make sure to adjust the level of output signal from the MONITOR OUT jack with the MONITOR knob.</p>

<p>■ Cannot record to a USB device</p>	<p><input type="checkbox"/> Is the USB device write-protected?</p> <p><input type="checkbox"/> Does the USB device have sufficient capacity to save the data?</p> <p><input type="checkbox"/> Is the USB device formatted in FAT32 format?</p> <p><input type="checkbox"/> Since high transmission speed is required for recording in WAV format, recording songs to USB flash drives may not be possible. We recommend using HDD (hard disc drive) or SSD (solid-state drive) when recording songs. If you use a USB flash drive for recording songs, change the recording format to MP3:128k, MP3:192k, MP3:256k, or MP3:320k.</p> <p><input type="checkbox"/> If the memory is fragmented significantly, try running a defragmentation program on the computer.</p>
<p>■ iPod/iPhone signal is not output.</p>	<p><input type="checkbox"/> Is the output signal assignment set appropriately? (page 36)</p> <p><input type="checkbox"/> Is the iPod indicator turned off? The unit has not recognized your iPod/iPhone. Check which iPod/iPhone models are supported.</p>
<p>■ The supported iPod/iPhone is not recognized.</p>	<p><input type="checkbox"/> If your iPod/iPhone has not been charged, it may take some time to be recognized by the mixer. Please wait.</p>
<p>■ When a stereo signal is input, the left and right volume is different.</p>	<p><input type="checkbox"/> Is the pan knob set to the center position? If it is located in the center, try swapping the connections. If the lesser/greater volume signals are also switched, check the connected device(s).</p> <p><input type="checkbox"/> Is the same type of cable used for the right and left signals? A cable with resistance lowers the volume.</p>
<p>■ The sound level is inconsistent, or there is an unnatural “pumping” in the sound.</p>	<p><input type="checkbox"/> Are you applying the compressor at an appropriate level? You might have to lower the COMP knob levels.</p>
<p>■ The Leveler is not enabled.</p>	<p><input type="checkbox"/> Is the GAIN knob on the stereo channels adjusted appropriately? The leveler may not be enabled if you increase the gain too much.</p>

* If any specific problem should persist, please contact your Yamaha dealer.

Appendix

Message List

■MESSAGE

Message	Meaning
Audio File Not Found!	The (playable) audio file that was to play does not exist in the folder.
Backup Memory Initialized!	User memory was initialized by the procedure on page 39.
Cannot be Used While Recording!	You attempted to perform the restricted operations such as displaying a title list while recording.
Storage Not Ready!	You attempted to start recording or playback when the USB device was not inserted or was not recognized.

■WARNING

This warning screen appears when an inappropriate device is connected to the USB connector, or when an operation results in an abnormal exit.

Message	Meaning
Backup Memory Force Initialized!	Since data beyond the parameter range was written in the memory, the memory was forced to be initialized.
Cannot Start Recording!	Recording did not start due to the status of the USB device.
Connection Failed! Reconnect iPod.	The connection of the iPod to the unit failed. Reconnect the iPod.
Current Exceeded! (iPod)	The device connected to the iPod/iPhone IN connector exceeded current. Disconnect the device.
Current Exceeded! (USB)	The device connected to the USB IN connector exceeded current. Disconnect the device.
Illegal Device! (iPod)	An unsupported device such as a USB flash drive was connected to the iPod/iPhone IN connector.
Illegal Device! (USB)	A device with an invalid or unsupported format was connected to the USB IN connector.
Number of Files Exceeded!	Since the total number of files and folders in the USB device has exceeded 4,000, no more files can be loaded. Delete any unnecessary files using the computer.
Playback Aborted!	Playback was suspended because you disconnected the USB device during playback.
Recording Aborted!	Recording was suspended because you disconnected the USB device or the response of the USB device was slow.
Storage Full!	The USB device capacity is insufficient.

■ERROR

This error screen appears when trouble is found in a connection inside the MGP32X/MGP24X. Please contact your Yamaha dealer.

Message	Meaning
Device Check Error! XXXXXXXX	There is a problem in the device indicated by xxxxxxxx, or in the connection between the device and the CPU. Please contact your Yamaha dealer.

Effect Program List

■FX1 REV-X (REV-X algorithm)

No.	Program	Description
01	HALL	Reverb simulating a large space such as a hall.
02	WARM HALL	Warm reverb simulating a hall.
03	BRIGHT HALL	Bright reverb simulating a hall.
04	PLATE 1	Reverb simulating a metal-plate. Suitable for vocals.
05	PLATE 2	Reverb simulating a metal-plate. Suitable for snare drum sound.
06	ROOM	Reverb simulating the acoustics of a small space (room).
07	WARM ROOM	Warm reverb simulating the acoustics of a small space (room).
08	SLAP ROOM	Reverb simulating a slap echo of a small space (room).

■FX2 SPX (SPX algorithm)

No.	Program	Description
01	HALL	Reverb simulating a large space such as a hall.
02	ROOM	Reverb simulating the acoustics of a small space (room).
03	PLATE	Reverb simulating a metal-plate, producing a more hard-edged sound.
04	LARGE STAGE	Reverb simulating a large stage.
05	SMALL STAGE	Reverb simulating a small stage.
06	VOCAL ECHO	Echo suitable for vocals.
07	KARAOKE ECHO	Echo suitable for karaoke.
08	DELAY	Feedback delay adding multiple delayed signals.
09	SINGLE DELAY	Mono delay adding a delayed signal.
10	EARLY REF.	Early reflections without the subsequent reverb. Applies a more elaborate effect than conventional reverb.
11	CHORUS	Creates a thick sound by modulating the delay time.
12	PHASER	Phase modulation produces a cyclical phasing effect.
13	FLANGER	Creates a tone with pitched effect.
14	SYMPHONIC	Creates a thick sound by multiplexing the sound.
15	DOUBLER	Creates an illusion of two people singing the same phrase.
16	RADIO VOICE	Reproduces a lo-fi feel in the style of the AM radio. Adjust the parameter to change the frequency range to be emphasized.

Parameter List

The first parameter located in each program table appears on the FX1 screen's (1/2) MAIN page and the FX2 screen's (1/2) MAIN page.

■ Effect Parameter List

● FX1 REV-X (all programs; 01: HALL through 08: SLAP ROOM)

Parameter	Range	Description
Rev Time	0.3 – 10.0 s (HALL, WARM HALL, BRIGHT HALL, PLATE 1, PLATE 2)	Reverb time
	0.3 s – 3.2 s (ROOM, WARM ROOM, SLAP ROOM)	
Diffusion	0 – 10	Reverb diffusion (left–right reverb spread)
Ini Delay	0.1 – 200.0 ms	Initial delay before reverb begins
Room Size	0 – 31	Reflection spacing

● FX2 SPX (01: HALL, 02: ROOM, 03: PLATE, 04: LARGE STAGE, 05: SMALL STAGE)

Parameter	Range	Description
Rev Time	0.3 – 10.0 s (HALL, PLATE, LARGE STAGE, SMALL STAGE)	Reverb time
	0.3 s – 3.2 s (ROOM)	
Diffusion	0 – 10	Reverb diffusion (left–right reverb spread)
Ini Delay	0.1 – 99.3 ms	Initial delay before reverb begins
Hi Damp	0.1 – 1.0	High-frequency reverb amount

● FX2 SPX (06: VOCAL ECHO, 07: KARAOKE ECHO, 08: DELAY)

Parameter	Range	Description
Delay	30.0 – 710.0 ms (VOCAL ECHO)	Delay time VOCAL ECHO R channel = the value in the left column plus 33.0 ms KARAOKE ECHO R channel = the value in the left column plus 65.0 ms DELAY R channel (Mode: MONO) = the same value in the left column DELAY R channel (Mode: STEREO) = the double value in the left column
	40.0 – 200.0 ms (KARAOKE ECHO)	
	20.0 – 743.0 ms (DELAY)	
FB Level	-63 to +63	Feedback level
Hi Damp	0.1 – 1.0	High-frequency feedback amount
Mode	MONO, STEREO	(08:DELAY only) MONO = mono delay STEREO = stereo ping pong delay

● FX2 SPX (09: SINGLE DELAY)

Parameter	Range	Description
Delay	0.1 – 743.0 ms	Delay time

● FX2 SPX (10: EARLY REF.)

Parameter	Range	Description
Room Size	0.1 – 10.0	Reflection spacing
Type	S-H (S-Hall), L-H (L-Hall), Rdm (Random), Rvs (Revers), Plt (Plate), Spr (Spring)	Type of early reflection simulation
Diffusion	0 – 10	Reflection diffusion (left–right reflection spread)
Ini Delay	0.1 – 200.0 ms	Initial delay before reflection begins
FB Level	-63 to +63	Feedback level

● FX2 SPX (11: CHORUS)

Parameter	Range	Description
Frequency	0.00 – 39.7 Hz	Modulation frequency
Depth	0 – 127	Modulation depth
FB Level	-63 to +63	Feedback level

● FX2 SPX (12: PHASER)

Parameter	Range	Description
Frequency	0.00 – 39.7 Hz	Modulation frequency
Depth	0 – 127	Modulation depth
Offset	0 – 127	Modulation offset
FB Level	-63 to +63	Feedback level
Stage	4 – 22	Number of phase shift stages

● FX2 SPX (13: FLANGER)

Parameter	Range	Description
Frequency	0.00 – 39.7 Hz	Modulation frequency
Depth	0 – 127	Modulation depth
FB Level	-63 to +63	Feedback level
Delay	0.0 – 50.0 ms	Delay offset

● FX2 SPX (14: SYMPHONIC)

Parameter	Range	Description
Frequency	0.00 – 39.7 Hz	Modulation frequency
Depth	0 – 127	Modulation depth
Delay	0.0 – 50.0 ms	Delay offset

● FX2 SPX (15: DOUBLER)

Parameter	Range	Description
Depth	0 – 32	Pitch shift depth
Range	0 – 12	Pitch range
Type	Sound4 – Sound1, Normal, Rythm1 – Rythm4	Effect type

● FX2 SPX (16: RADIO VOICE)

Parameter	Range	Description
Cutoff	0 – 127	Filter cutoff
Drive	0 – 127	Distortion drive level
LPF	1.0 kHz – 18.0 kHz, Thru	LPF frequency

■ COMP/DUCKER/LEVELER Parameter List

● COMPRESSOR

If a signal higher than a specified threshold level is input, the output level is adjusted by a specified ratio.

Type=Comp

Parameter	Range	Description
Threshold	-48 to -6 dB	This determines the level of input signal required to trigger the compressor.
Ratio	1.0 – 20.0	This determines the amount of compression. A larger value results in a stronger compression effect.
Attack	1 – 40 ms	This determines how soon the signal will be compressed once the compressor has been triggered.
Release	10 – 680 ms	This determines how soon the compressor returns to its normal gain once the trigger signal level drops below the threshold.
Out Level	-12 to +12 dB	This sets the compressor's output signal level.

Type=MultiBand

Parameter	Range	Description
L-M Xover	21.2 Hz – 4.0 kHz	Low/mid crossover frequency
M-H Xover	42.5 Hz – 8.0 kHz	Mid/high crossover frequency
Release	10 – 3000 ms	This determines how soon the compressor returns to its normal gain once the trigger signal level drops below the threshold.
Out Level	-12 to +12 dB	Output level
L/(M/H)-Thresh	-54 to -6 dB	This determines the level of input signal required to trigger the low/mid/high band compressor.
L/(M/H)-Ratio	1.0 – 20.0	This determines the amount of low/mid/high band compression. A larger value results in a stronger compression effect.
L/(M/H)-Attack	1 – 200 ms	Low/mid/high band compressor attack
L/(M/H)-Gain	-INF, -36 to +18 dB	Low/mid/high band compressor gain
L/(M/H)-Bypass	ON, OFF	Low/mid/high band bypass on/off

● DUCKER

If the selected input source signal level exceeds the specified threshold level, the output level is attenuated by a specified amount (range).



Parameter	Range	Description
Source	CH24 (CH16), GROUP1	This determines whether the ducker source signal is channel 24 {16} or GROUP1.
Threshold	-60 to 0 dB	This determines the level of trigger signal required to active the ducker. If the source input signal exceeds this level, the ducker begins to be applied.
Range	-70 to 0 dB	This determines the amount of attenuation when the ducker is activated.
Release	1 ms – 50 s	This determines how soon the ducker returns to its normal gain once the trigger signal level drops below the threshold.

● LEVELER

If a signal higher than a specified threshold level is input, the output level is adjusted to the specified level.

Parameter	Range	Description
Threshold	-60 to 0 dB	This determines the level of input signal required to trigger the leveler.
Out Gain	-20 to +40 dB	This sets leveler's output signal level.

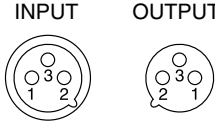
Jack List

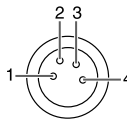
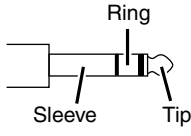
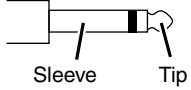
Input and Output Jacks	Polarities	Configurations
INPUT A (mono channels), MONO OUT, AUX SEND, STEREO OUT	Pin 1: Ground Pin 2: Hot (+) Pin 3: Cold (-)	 <p>XLR-3-31/XLR-3-32 connector</p>
TALKBACK	Pin 1: Ground Pin 2: Hot (+) Pin 3: Cold (-)	 <p>XLR-3-31 connector</p>
LAMP	Pin 1: NC Pin 2: NC Pin 3: Ground Pin 4: +12 V	 <p>XLR-4-31 connector</p>
* INPUT B (mono channels), STEREO OUT, GROUP OUT, MATRIX OUT, MONITOR OUT	Tip: Hot (+) Ring: Cold (-) Sleeve: Ground	 <p>TRS Phone plug</p>
INSERT (mono channels), STEREO INSERT	Tip: Output Ring: Input Sleeve: Ground	
PHONES	Tip: L Ring: R Sleeve: Ground	
LINE (stereo channels)	Tip: Hot Sleeve: Ground	 <p>Phone plug</p>

* These jacks will also accept connection to phone plugs. If you use monaural plugs, the connection will be unbalanced.

Dimensions

MGP32X

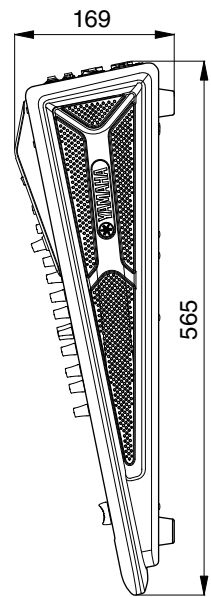
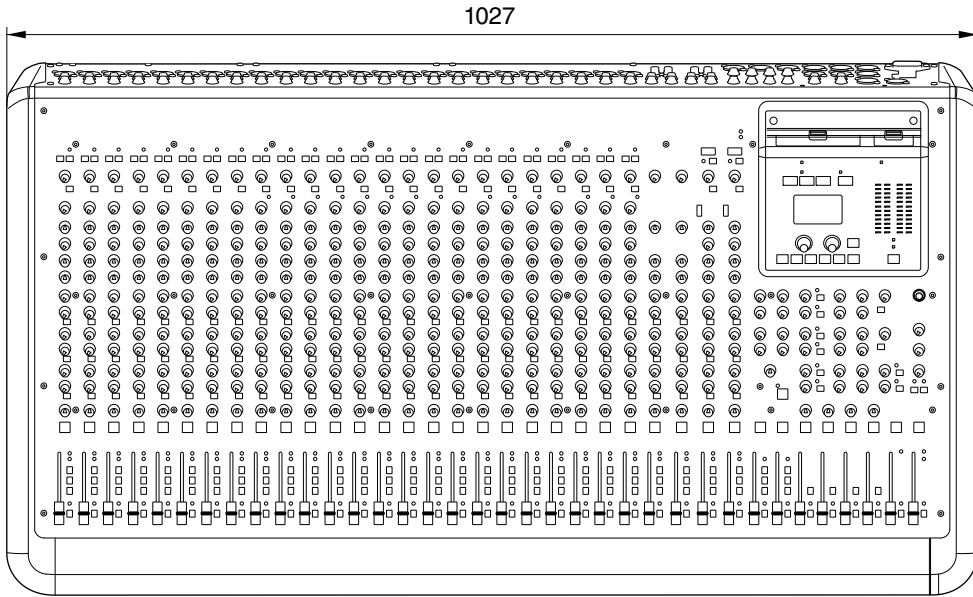
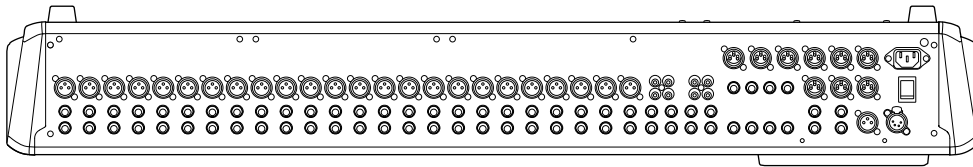

MGP24X

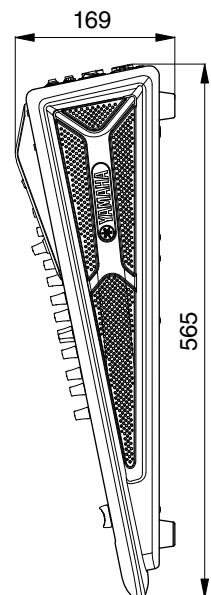
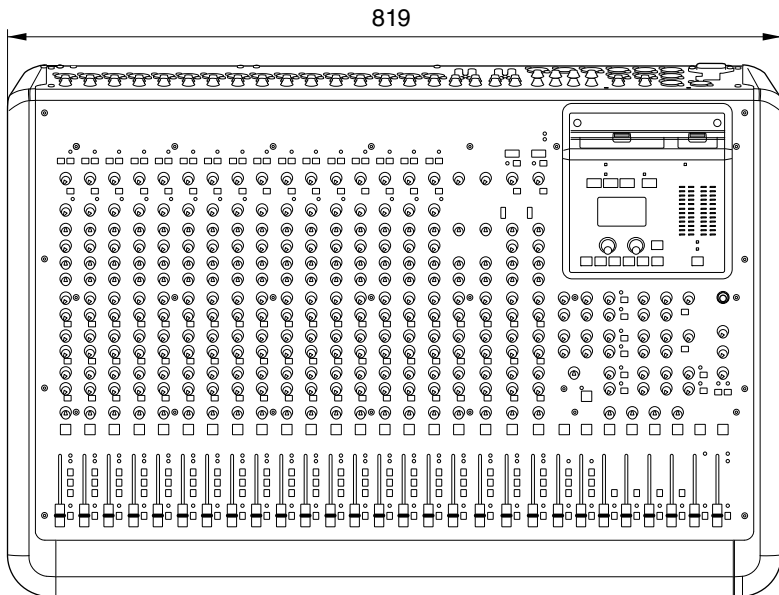
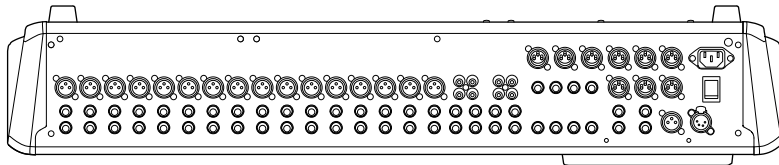

Unit: mm

Specifications

■ Electrical Characteristics

0 dBu = 0.775 Vrms, 0 dBV = 1 Vrms

Output impedance of signal generator (Rs) = 150 Ω

Output load impedance = 10 kΩ (TRS phone output), 600 Ω (XLR output)

Nominal fader position is 10dB lower than the maximum position.

All faders are set to nominal position when dedicated in the below.

				UNIT
Frequency Response		20 Hz to 20 kHz GAIN knob: min Refer to the nominal output level @ 1 kHz	+0.5/-1.0	dB
Total Harmonic Distortion (THD + N)	STEREO OUT	GAIN knob: min output level: +14 dBu @ 20 Hz to 20 kHz	0.02	%
Noise*1	CH INPUT MIC	EIN (Equivalent Input Noise): Rs = 150 Ω GAIN knob: max	-128	dBu
	STEREO OUT	STEREO master fader: nominal Bus assign switch: off (All)	-84	dBu
	GROUP OUT	GROUP master fader: nominal Bus assign switch: off (All)	-90	dBu
	AUX SEND	AUX master knob: nominal CH mix control: min (All)	-82	dBu
	STEREO OUT	Residual output noise	-92	dBu
Crosstalk*2 @ 1 kHz	Adjacent Input	Between input channels	-74	dB
	Input to Output	STEREO OUT L, R PAN knob: panned hard left or right	-74	dB
Maximum Voltage Gain*3 @ 1 kHz	MONO CH Input MIC to	CH INSERT OUT	60	dB
		STEREO INSERT OUT	70	dB
		STEREO OUT	84	dB
		GROUP OUT	84	dB
		MONITOR OUT	80	dB
		PHONES OUT	69	dB
		AUX SEND (PRE)	76	dB
		AUX SEND (POST)	86	dB
	MATRIX OUT	90	dB	
	STEREO CH Input to	STEREO OUT	58	dB
		GROUP OUT	58	dB
		AUX SEND (PRE)	50	dB
		AUX SEND (POST)	60	dB
TALKBACK Input to	STEREO OUT	70	dB	

*1 Noise is measured with a A-Weighting filter.

*2 Crosstalk is measured with a 1 kHz band pass filter.

*3 Maximum voltage gain is measured under the condition that all faders and GAIN knobs are at maximum.
PAN/BAL knob is panned hard left or right.

European models

Purchaser/User Information specified in EN55103-2:2009.

Conforms to Environments: E1, E2, E3 and E4

■ Analog Input Characteristics

Input Terminals	PAD	GAIN TRIM	Actual Load Impedance	For Use With Nominal	Input level			Connector
					Sensitivity*1	Nominal	Max. before clip	
MONO CH Input MGP32X: 1–24 MGP24X: 1–16	0	-60 dB	3 k Ω	50–600 Ω Mics	-80 dBu (0.078 mV)	-60 dBu (0.775 mV)	-40 dBu (7.75 mV)	XLR-3-31 type*2 Phone Jack*4
		-16 dB			-36 dBu (12.3 mV)	-16 dBu (123 mV)	+4 dBu (1.23 V)	
	26 dB	-34 dB		600 Ω Lines	-54 dBu (1.55 mV)	-34 dBu (15.5 mV)	-14 dBu (155 mV)	Phone Jack*3
		+10 dB			-10 dBu (245 mV)	+10 dBu (2.45 V)	+30 dBu (24.5 V)	
ST CH Input MGP32X: 25–32 MGP24X: 17–24	—	-34 dB	10 k Ω	600 Ω Lines	-54 dBu (1.55 mV)	-34 dBu (15.5 mV)	-14 dBu (155 mV)	Phone Jack*4 RCA Pin Jack
		+10 dB			-10 dBu (245 mV)	+10 dBu (2.45 V)	+30 dBu (24.5 V)	
MONO CH INSERT Input MGP32X: 1–24 MGP24X: 1–16	—	—	10 k Ω	600 Ω Lines	-20 dBu (77.5 mV)	0 dBu (0.775 V)	+20 dBu (7.75 V)	Phone Jack*5
ST CH INSERT Input L, R	—	—	10 k Ω	600 Ω Lines	-20 dBu (77.5 mV)	0 dBu (0.775 V)	+20 dBu (7.75 V)	Phone Jack*5
TALKBACK Input	—	—	10 k Ω	50–600 Ω Mics	-66 dBu (0.389 mV)	-50 dBu (2.45 mV)	-30 dBu (24.5 mV)	XLR-3-31 type*6

0 dBu is referenced to 0.775 Vrms. 0 dBV is referenced to 1 Vrms.

*1 Sensitivity is the lowest level that will produce an output of +4 dB (1.23 V), or the nominal output level when the unit is set to maximum level. (all faders and level controls are at maximum position.)

*2 XLR-3-31 type connectors are balanced. (1=GND, 2=HOT, 3=COLD)

*3 Phone Jacks are balanced. (Tip=HOT, Ring=COLD, Sleeve=GND)

*4 Phone Jacks are unbalanced.

*5 Phone Jacks are unbalanced. (Tip=Out, Ring=In, Sleeve=GND)

*6 XLR-3-31 type connectors is unbalanced.

■ Analog Output Characteristics

Output Terminals	Actual Source Impedance	For Use With Nominal	Output Level		Connector
			Nominal	Max. before clip	
STEREO OUT L, R	75 Ω	600 Ω Lines	+4 dBu (1.23 V)	+24 dBu (12.3 V)	XLR-3-32 type*1 Phone Jack*4
MONO OUT	75 Ω	600 Ω Lines	+4 dBu (1.23 V)	+24 dBu (12.3 V)	XLR-3-32 type*1
GROUP OUT 1–4	150 Ω	10 k Ω Lines	+4 dBu (1.23 V)	+20 dBu (7.75 V)	Phone Jack*2
AUX SEND 1–6	75 Ω	600 Ω Lines	+4 dBu (1.23 V)	+24 dBu (12.3 V)	XLR-3-32 type*1
MATRIX OUT 1–2	150 Ω	10 k Ω Lines	+4 dBu (1.23 V)	+20 dBu (7.75 V)	Phone Jack*2
MONO CH INSERT OUT MGP32X: 1–24 MGP24X: 1–16	75 Ω	10 k Ω Lines	0 dBu (0.775 V)	+20 dBu (7.75 V)	Phone Jack*3
ST CH INSERT OUT L, R	75 Ω	10 k Ω Lines	0 dBu (0.775 V)	+20 dBu (7.75 V)	Phone Jack*3
MONITOR OUT L, R	150 Ω	10 k Ω Lines	+4 dBu (1.23 V)	+20 dBu (7.75 V)	Phone Jack*2
PHONES OUT	150 Ω	40 Ω Phones	3 mW	75 mW	Stereo Phone Jack

0 dBu is referenced to 0.775 Vrms. 0 dBV is referenced to 1 Vrms.

*1 XLR-3-32 type connectors are balanced. (1=GND, 2=HOT, 3=COLD)

*2 Phone Jacks are impedance balanced. (Tip=HOT, Ring=COLD, Sleeve=GND)

*3 Phone Jacks are unbalanced. (Tip=Out, Ring=In, Sleeve=GND)

*4 Phone Jacks are balanced. (Tip=HOT, Ring=COLD, Sleeve=GND)

■ General Specifications

Input Channel HPF		100 Hz, 12 dB/oct	
Input Channel EQ	HIGH	8 kHz, shelving	
	MID	MGP32X: CHs 1–24, 29–32: 250 Hz to 5 kHz, peaking CHs 25–28: 2.5 kHz, peaking MGP24X: CHs 1–16, 21–24: 250 Hz to 5 kHz, peaking CHs 17–20: 2.5 kHz, peaking	
	LOW	125 Hz, shelving	
Input Channel Compressor		Parameters (ratio, threshold, output gain) are controlled by one knob.	
Digital Signal Processing	DUCKER	MGP32X CHs 29/30, 31/32 (DUCKER SOURCE: CH24 or GROUP1) MGP24X CHs 21/22, 23/24 (DUCKER SOURCE: CH16 or GROUP1)	
	LEVELER	MGP32X CHs 29/30, 31/32 MGP24X CHs 21/22, 23/24	
	STEREO IMAGE	MGP32X CHs 29/30, 31/32 MGP24X CHs 21/22, 23/24	
	FX1: Rev-X	8 Programs 01: HALL 04: PLATE 1 07: WARM ROOM 02: WARM HALL 05: PLATE 2 08: SLAP ROOM 03: BRIGHT HALL 06: ROOM	
	FX2: SPX	16 Programs 01: HALL 04: LARGE PLATE 07: KARAOKE ECHO 10: EARLY REF. 13: FLANGER 16: RADIO VOICE 02: ROOM 05: SMALL STAGE 08: DELAY 11: CHORUS 14: SYMPHONIC 03: PLATE 06: VOCAL ECHO 09: SINGLE DELAY 12: PHASER 15: DOUBLER	
	GEQ	STEREO OUT L/R TYPE : 14BandGEQ, Flex9GEQ 8 User Programs	
	COMP	STEREO OUT L/R TYPE : Comp, MultiBand 3 Preset Programs, 5 User Programs	
	USB Audio	USB device recorder (USB to device)	Device
File System			FAT32
Audio File format (Playback)			
MPEG Audio 1, 2, 2.5			Sample rate: 8 k - 48 kHz Bit rate: 8 k - 320 kbps, VBR
MPEG4 AAC-LC			Sample rate: 8 k - 48 kHz Bit rate : 8 k - 320 kbps, VBR
WAV File			Sample rate: 8 k - 48 kHz 16bit PCM
for iPod/iPhone (USB for iPod)	Supported Devices*	Audio File format (Record)	
		MP3 (MPEG1 Layer3)	Sample Rate: 44.1 kHz Bit rate: 128 k, 192 k, 256 k, 320 kbps
		WAV	Sample Rate: 44.1 kHz 16bit PCM
		Connector Specification	USB A Type
		Format	iPod, iPhone exclusive
		Connector Specification	USB A Type
Signal Indicator	CH Input	PEAK indicator (red): PEAK lights if the signal comes within 3 dB of the clipping level. SIG indicator (green)	
LED Level Meter		4 × 12 segments LED meter: (PEAK, +10, +6, +3, 0, -3, -6, -10, -15, -20, -25, -30 dB) Metering point: post stereo master fader or pre monitor level	
Phantom Voltage		+48V	
Lamp		XLR-4-31 type, The Lamp voltage is 12V DC between 3 and 4 pins of XLR-4-31 connector. Lamp can use 5W max.	
Power Supply	Requirements	100–240 V 50/60 Hz	
	Power Consumption	MGP32X: 86 W (max), MGP24X: 76 W (max)	
Dimensions (W x H x D)		MGP32X: 1,027 mm x 169 mm x 565 mm (40.4" x 6.7" x 22.2") MGP24X: 819 mm x 169 mm x 565 mm (32.2" x 6.7" x 22.2")	
Weight		MGP32X: 19 kg (41.9 lb.), MGP24X: 15.5 kg (34.2 lb.)	

* The device may not function depending on your iPod/iOS software version.
For updated information, check the Yamaha Pro Audio web site (<http://www.yamahaproaudio.com/>).

* Specifications and descriptions in this owner's manual are for information purposes only. Yamaha Corporation reserves the right to modify products or specifications at any time without prior notice. Since specifications, equipment, and options may not be the same in every locale, please check with your Yamaha dealer.

Index

A

AUX 13

B

Background music 6, 37
Backlight 25
BAL (Balance) 13
Bus 13

C

Compressor 11, 31
Compressor program 32
Condenser microphone 9, 11
Contrast 25

D

Delay 26
Delay time 17
DI box (direct box) 9
Dialog screen 24
Display 16, 24
Ducker 6, 12, 37, 38

E

Echo 26
Effect 13, 26
Effect programs 26
Effect return 17
Equalizer 12

F

Factory default settings 39
Fast forwarding 35
Fast rewinding 35
Feedback 29
Frequency 12, 28
FX (effect) 13, 17, 26

G

Gain 28
GEQ program 30
Graphic EQ (GEQ) 28

H

Head amplifier 6
Headphones 7, 19
High Pass Filter 11

I

Initializing 39
Instruments 7
iPod/iPhone 15, 36

J

Jack List 46

L

Leveler 6, 12, 38
Link 29
List 25
Low Pass Filter 37
LPF (Low Pass Filter) 37

M

Maintenance 5
MATRIX 18
Meter 16
MGP Editor 6
Microphone 7, 8, 9
MONITOR 19

N

Navigating through a song 35

P

Pan 6, 13
Parameter value 25
Pausing 35
PFL (Pre-Fader Listen) 13
Phantom power 11
Pre-fader 13

R

Resetting 39
Reverb 26

S

Setup Example 8
Software application (MGP Editor) 6
Song 34
Speaker 7, 8
Stereo Image 6, 12
STEREO L and R buses 13, 21, 33

T

TALKBACK 20
TAP 17
Transport 15

U

USB cable 36
USB device 33
 Available recording time 33
 Capacity 33
 File format 33
 Format 33
 Playing back 33
 Recording 33
USB device recorder 15

V

Volume balance 13

Block Diagram and Level Diagram

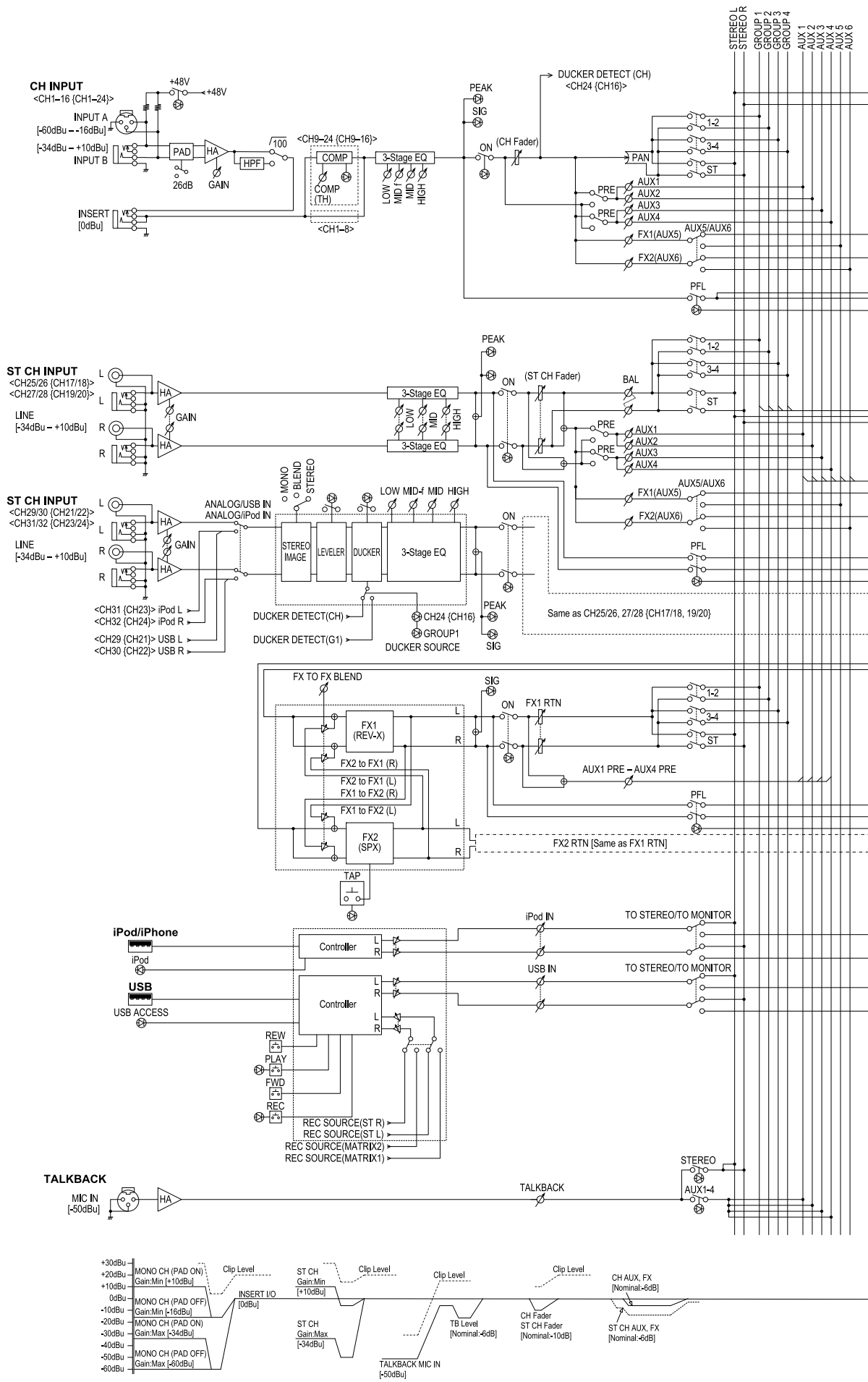

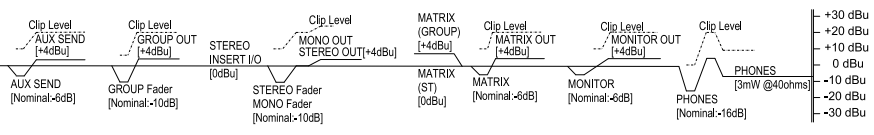
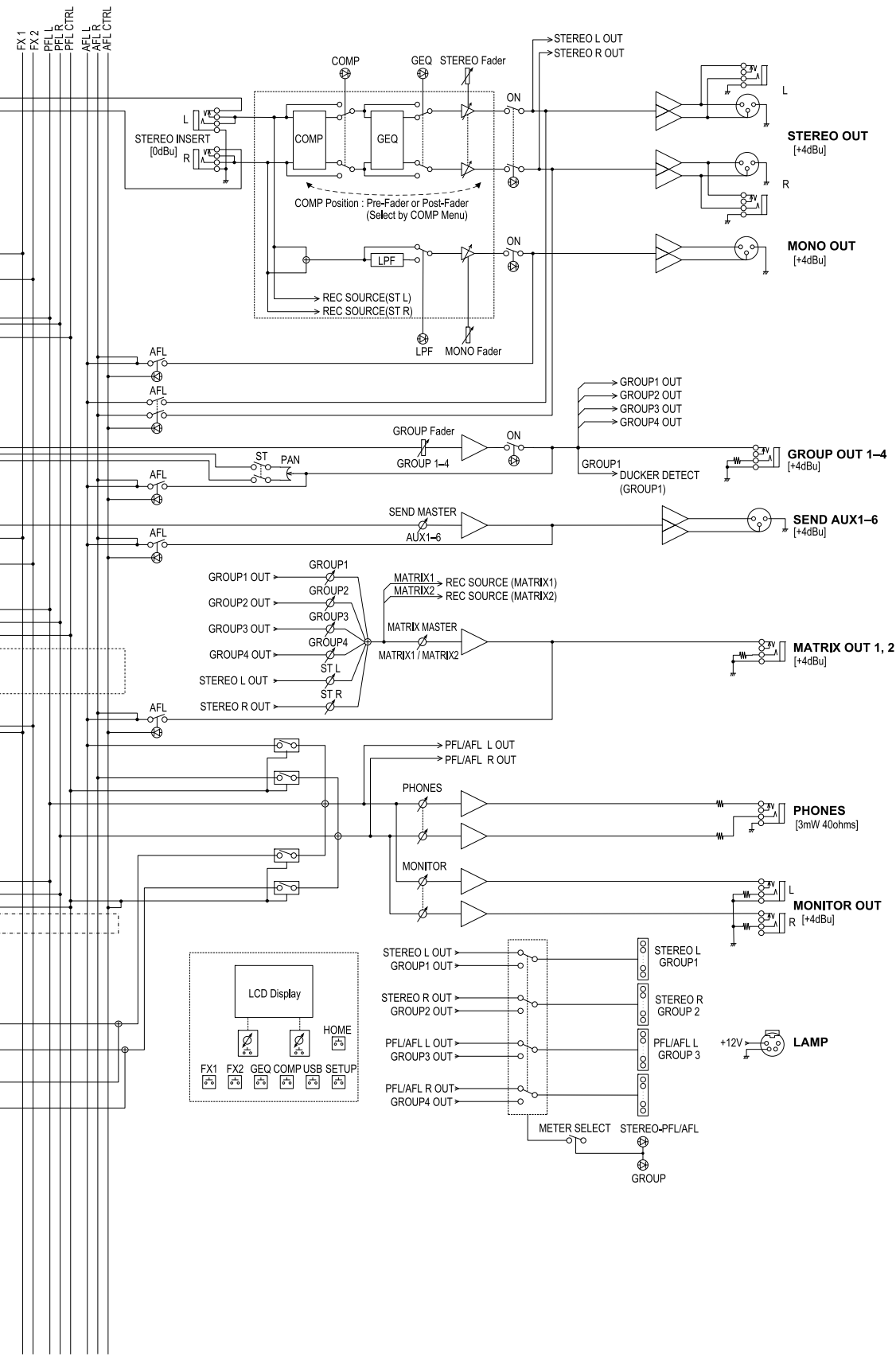

Important Notice: Guarantee Information for customers in European Economic Area (EEA) and Switzerland

<p>Important Notice: Guarantee Information for customers in EEA* and Switzerland</p> <p>For detailed guarantee information about this Yamaha product, and Pan-EEA* and Switzerland warranty service, please either visit the website address below (Printable file is available at our website) or contact the Yamaha representative office for your country. * EEA: European Economic Area</p>	English
<p>Wichtiger Hinweis: Garantie-Information für Kunden in der EWR* und der Schweiz</p> <p>Für nähere Garantie-Information über dieses Produkt von Yamaha, sowie über den Pan-EWR*- und Schweizer Garantieservice, besuchen Sie bitte entweder die folgend angegebene Internetadresse (eine druckfähige Version befindet sich auch auf unserer Webseite), oder wenden Sie sich an den für Ihr Land zuständigen Yamaha-Vertrieb. *EWR: Europäischer Wirtschaftsraum</p>	Deutsch
<p>Remarque importante: informations de garantie pour les clients de l'EEE et la Suisse</p> <p>Pour des informations plus détaillées sur la garantie de ce produit Yamaha et sur le service de garantie applicable dans l'ensemble de l'EEE ainsi qu'en Suisse, consultez notre site Web à l'adresse ci-dessous (le fichier imprimable est disponible sur notre site Web) ou contactez directement Yamaha dans votre pays de résidence. * EEE : Espace Economique Européen</p>	Français
<p>Belangrijke mededeling: Garantie-informatie voor klanten in de EER* en Zwitserland</p> <p>Voor gedetailleerde garantie-informatie over dit Yamaha-product en de garantieservice in heel de EER* en Zwitserland, gaat u naar de onderstaande website (u vindt een afdrukbaar bestand op onze website) of neemt u contact op met de vertegenwoordiging van Yamaha in uw land. * EER: Europese Economische Ruimte</p>	Nederlands
<p>Aviso importante: información sobre la garantía para los clientes del EEE* y Suiza</p> <p>Para una información detallada sobre este producto Yamaha y sobre el soporte de garantía en la zona EEE* y Suiza, visite la dirección web que se incluye más abajo (la versión del archivo para imprimir esta disponible en nuestro sitio web) o póngase en contacto con el representante de Yamaha en su país. * EEE: Espacio Económico Europeo</p>	Español
<p>Avviso importante: informazioni sulla garanzia per i clienti residenti nell'EEA* e in Svizzera</p> <p>Per informazioni dettagliate sulla garanzia relativa a questo prodotto Yamaha e l'assistenza in garanzia nei paesi EEA* e in Svizzera, potete consultare il sito Web all'indirizzo riportato di seguito (è disponibile il file in formato stampabile) oppure contattare l'ufficio di rappresentanza locale della Yamaha. * EEA: Area Economica Europea</p>	Italiano
<p>Aviso importante: informações sobre as garantias para clientes da AEE* e da Suíça</p> <p>Para obter uma informação pormenorizada sobre este produto da Yamaha e sobre o serviço de garantia na AEE* e na Suíça, visite o site a seguir (o arquivo para impressão está disponível no nosso site) ou entre em contato com o escritório de representação da Yamaha no seu país. * AEE: Área Económica Européia</p>	Português
<p>Σημαντική σημείωση: Πληροφορίες εγγύησης για τους πελάτες στον ΕΟΧ* και Ελλάδα</p> <p>Για λεπτομερείς πληροφορίες εγγύησης σχετικά με το παρόν προϊόν της Yamaha και την κάλυψη εγγύησης σε όλες τις χώρες του ΕΟΧ και την Ελλάδα, επισκεφτείτε την παρακάτω ιστοσελίδα (Εκτυπώσιμη μορφή είναι διαθέσιμη στην ιστοσελίδα μας) ή απευθυνθείτε στην αντιπροσωπεία της Yamaha στη χώρα σας. * ΕΟΧ: Ευρωπαϊκός Οικονομικός Χώρος</p>	Ελληνικά
<p>Viktigt: Garantiinformation för kunder i EES-området* och Schweiz</p> <p>För detaljerad information om denna Yamaha-produkt samt garantiservice i hela EES-området* och Schweiz kan du antingen besöka nedanstående webbadress (en utskriftsvänlig fil finns på webbplatsen) eller kontakta Yamahas officiella representant i ditt land. * EES: Europeiska Ekonomiska Samarbetsområdet</p>	Svenska
<p>Viktig merknad: Garantiinformasjon for kunder i EØS* og Sveits</p> <p>Detaljert garantiinformasjon om dette Yamaha-produktet og garantiservice for hele EØS-området* og Sveits kan fås enten ved å besøke nettstedene nedenfor (utskriftsversjon finnes på våre nettsider) eller kontakte Yamahas kontoret i landet der du bor. *EØS: Det europeiske økonomiske samarbeidsområdet</p>	Norsk
<p>Vigtig oplysning: Garantioplysninger til kunder i EØO* og Schweiz</p> <p>De kan finde detaljerede garantioplysninger om dette Yamaha-produkt og den fælles garantiserviceordning for EØO* (og Schweiz) ved at besøge det websted, der er angivet nedenfor (der findes en fil, som kan udskrives, på vores websted), eller ved at kontakte Yamahas nationale repræsentationskontor i det land, hvor De bor. * EØO: Det Europæiske Økonomiske Område</p>	Dansk
<p>Tärkeä ilmoitus: Takuutiedot Euroopan talousalueen (ETA)* ja Sveitsin asiakkaille</p> <p>Tämän Yamaha-tuotteen sekä ETA-alueen ja Sveitsin takuuta koskevat yksityiskohtaiset tiedot saatte alla olevasta nettiosoitteesta. (Tulostettava tiedosto saatavissa sivustollamme.) Voitte myös ottaa yhteyttä paikalliseen Yamaha-edustajaan. *ETA: Euroopan talousalue</p>	Suomi
<p>Ważne: Warunki gwarancyjne obowiązujące w EOG* i Szwajcarii</p> <p>Aby dowiedzieć się więcej na temat warunków gwarancyjnych tego produktu firmy Yamaha i serwisu gwarancyjnego w całym EOG* i Szwajcarii, należy odwiedzić wskazaną poniżej stronę internetową (Plik gotowy do wydruku znajduje się na naszej stronie internetowej) lub skontaktować się z przedstawicielstwem firmy Yamaha w swoim kraju. * EOG — Europejski Obszar Gospodarczy</p>	Polski
<p>Důležité oznámení: Záruční informace pro zákazníky v EHS* a ve Švýcarsku</p> <p>Podrobné záruční informace o tomto produktu Yamaha a záručním servisu v celém EHS* a ve Švýcarsku naleznete na níže uvedené webové adrese (soubor k tisku je dostupný na našich webových stránkách) nebo se můžete obrátit na zastoupení firmy Yamaha ve své zemi. * EHS: Evropský hospodářský prostor</p>	Česky
<p>Fontos figyelmeztetés: Garancia-információk az EGT* területén és Svájcban élő vásárlók számára</p> <p>A jelen Yamaha termékre vonatkozó részletes garancia-információk, valamint az EGT*-re és Svájcra kiterjedő garanciális szolgáltatás tekintetében keresse fel webhelyünket az alábbi címen (a webhelyen nyomtatható fájl is talál), vagy pedig lépjen kapcsolatba az országában működő Yamaha képviselői irodával. * EGT: Európai Gazdasági Térség</p>	Magyar
<p>Oluline märkus: Garantiteave Euroopa Majanduspiirkonna (EMP)* ja Šveitsi klientidele</p> <p>Täpsemat teabe saamiseks selle Yamaha toote garantii ning kogu Euroopa Majanduspiirkonna ja Šveitsi garantiiteeniduse kohta, külastage palun veebisaiti alljärgneval aadressil (meie saidil on saadaval printitav fail) või pöörduge Teie regiooni Yamaha esinduse poole. * EMP: Euroopa Majanduspiirkond</p>	Eesti keel
<p>Svarīgs paziņojums: garantijas informācija klientiem EEZ* un Šveicē</p> <p>Lai saņemtu detalizētu garantijas informāciju par šo Yamaha produktu, kā arī garantijas apkalpošanu EEZ* un Šveicē, lūdzmu, apmeklējiet zemāk norādīto tīmekļa vietnes adresi (tīmekļa vietnē ir pieejams drukājams fails) vai sazinieties ar jūsu valsti apkalpojošo Yamaha pārstāvniecību. * EEZ: Eiropas Ekonomikas zona</p>	Latviešu
<p>Dėmesio: informacija dėl garantijos pirkėjams EEE* ir Šveicarijoje</p> <p>Jei reikia išsamios informacijos apie šį „Yamaha“ produktą ir jo techninę priežiūrą visoje EEE* ir Šveicarijoje, apsilankykite mūsų svetainėje toliau nurodytu adresu (svetainėje yra spausdintinas failas) arba kreipkitės į „Yamaha“ atstovybę savo šaliai. *EEE – Europos ekonominė erdvė</p>	Lietuvių kalba
<p>Dôležité upozornenie: Informácie o záruke pre zákazníkov v EHP* a Švajčiarsku</p> <p>Podrobné informácie o záruke týkajúce sa tohto produktu od spoločnosti Yamaha a garančnom servise v EHP* a Švajčiarsku nájdete na webovej stránke uvedenej nižšie (na našej webovej stránke je k dispozícii súbor na tlač) alebo sa obráťte na zástupcu spoločnosti Yamaha vo svojej krajine. * EHP: Európsky hospodársky priestor</p>	Slovenčina
<p>Pomembno obvestilo: Informacije o garanciji za kupce v EGP* in Švici</p> <p>Za podrobnejše informacije o tem Yamahinem izdelku ter garancijskem servisu v celotnem EGP in Švici, obiščite spletno mesto, ki je navedeno spodaj (natisljiva datoteka je na voljo na našem spletnem mestu), ali se obrnite na Yamahinega predstavnika v svoji državi. * EGP: Evropski gospodarski prostor</p>	Slovenščina
<p>Важно съобщение: Информация за гаранцията за клиенти в ЕИП* и Швейцария</p> <p>За подробна информация за гаранцията за този продукт на Yamaha и гаранционното обслужване в паневропейската зона на ЕИП* и Швейцария или посетете посочения по-долу уеб сайт (на нашия уеб сайт има файл за печат), или се свържете с представителния офис на Yamaha във вашата страна. * ЕИП: Европейско икономическо пространство</p>	Български език
<p>Notificarea importantă: Informații despre garanție pentru clienții din SEE* și Elveția</p> <p>Pentru informații detaliate privind acest produs Yamaha și serviciul de garanție Pan-SEE* și Elveția, vizitați site-ul la adresa de mai jos (fișierul imprimabil este disponibil pe site-ul nostru) sau contactați biroul reprezentanței Yamaha din țara dumneavoastră. * SEE: Spațiul Economic European</p>	Limba română
<p>Važna obavijest: Informacije o jamstvu za države EGP-a i Švicarske</p> <p>Za detaljne informacije o jamstvu za ovaj Yamahin proizvod te jamstvenom servisu za cijeli EGP i Švicarsku, molimo Vas da posjetite web-stranicu navedenu u nastavku ili kontaktirate ovlaštenog Yamahinog dobavljača u svojoj zemlji. * EGP: Evropski gospodarski prostor</p>	Hrvatski

<https://europe.yamaha.com/warranty/>

URL_5

FCC INFORMATION (U.S.A.)

1. IMPORTANT NOTICE: DO NOT MODIFY THIS UNIT!

This product, when installed as indicated in the instructions contained in this manual, meets FCC requirements. Modifications not expressly approved by Yamaha may void your authority, granted by the FCC, to use the product.

2. IMPORTANT: When connecting this product to accessories and/or another product use only high quality shielded cables. Cable/s supplied with this product **MUST** be used. Follow all installation instructions. Failure to follow instructions could void your FCC authorization to use this product in the USA.

3. NOTE: This product has been tested and found to comply with the requirements listed in FCC Regulations, Part 15 for Class "B" digital devices. Compliance with these requirements provides a reasonable level of assurance that your use of this product in a residential environment will not result in harmful interference with other electronic devices. This equipment generates/uses radio frequencies and, if not installed and used according to the instructions found in the users manual, may cause interference harmful to the operation of other electronic devices. Compliance with FCC regulations does not guarantee that interference will not occur in all

installations. If this product is found to be the source of interference, which can be determined by turning the unit "OFF" and "ON", please try to eliminate the problem by using one of the following measures:

Relocate either this product or the device that is being affected by the interference.

Utilize power outlets that are on different branch (circuit breaker or fuse) circuits or install AC line filter/s.

In the case of radio or TV interference, relocate/reorient the antenna. If the antenna lead-in is 300 ohm ribbon lead, change the lead-in to co-axial type cable.

If these corrective measures do not produce satisfactory results, please contact the local retailer authorized to distribute this type of product. If you can not locate the appropriate retailer, please contact Yamaha Corporation of America, Electronic Service Division, 6600 Orangethorpe Ave, Buena Park, CA90620

The above statements apply **ONLY** to those products distributed by Yamaha Corporation of America or its subsidiaries.

* This applies only to products distributed by YAMAHA CORPORATION OF AMERICA.

이 기기는 가정용(B급) 전자파적합기기로서 주로 가정에서 사용하는 것을 목적으로 하며, 모든 지역에서 사용할 수 있습니다.

(class b korea)

The model number, serial number, power requirements, etc., may be found on or near the name plate, which is at the rear of the unit. You should note this serial number in the space provided below and retain this manual as a permanent record of your purchase to aid identification in the event of theft.

Model No.

Serial No.

(rear_en_01)

IMPORTANT NOTICE FOR THE UNITED KINGDOM

Connecting the Plug and Cord

WARNING: THIS APPARATUS MUST BE EARTHED IMPORTANT. The wires in this mains lead are coloured in accordance with the following code:

GREEN-AND-YELLOW	: EARTH
BLUE	: NEUTRAL
BROWN	: LIVE

As the colours of the wires in the mains lead of this apparatus may not correspond with the coloured markings identifying the terminals in your plug proceed as follows:

The wire which is coloured GREEN-and-YELLOW must be connected to the terminal in the plug which is marked by the letter E or by the safety earth symbol or colored GREEN or GREEN-and-YELLOW.

The wire which is coloured BLUE must be connected to the terminal which is marked with the letter N or coloured BLACK.

The wire which is coloured BROWN must be connected to the terminal which is marked with the letter L or coloured RED.

(3 wires)

Information for Users on Collection and Disposal of Old Equipment



This symbol on the products, packaging, and/or accompanying documents means that used electrical and electronic products should not be mixed with general household waste.

For proper treatment, recovery and recycling of old products, please take them to applicable collection points, in accordance with your national legislation and the Directives 2002/96/EC.

By disposing of these products correctly, you will help to save valuable resources and prevent any potential negative effects on human health and the environment which could otherwise arise from inappropriate waste handling.

For more information about collection and recycling of old products, please contact your local municipality, your waste disposal service or the point of sale where you purchased the items.

[For business users in the European Union]

If you wish to discard electrical and electronic equipment, please contact your dealer or supplier for further information.

[Information on Disposal in other Countries outside the European Union]

This symbol is only valid in the European Union. If you wish to discard these items, please contact your local authorities or dealer and ask for the correct method of disposal.

(weee_eu_en_01)

ADDRESS LIST

NORTH AMERICA

CANADA

Yamaha Canada Music Ltd.
135 Milner Avenue, Toronto, Ontario,
M1S 3R1, Canada
Tel: +1-416-298-1311

U.S.A.

Yamaha Corporation of America
6600 Orangethorpe Avenue, Buena Park, CA 90620,
U.S.A.
Tel: +1-714-522-9011

CENTRAL & SOUTH AMERICA

MEXICO

Yamaha de México, S.A. de C.V.
Av. Insurgentes Sur 1647 Piso 9, Col. San José
Insurgentes, Delegación Benito Juárez, CDMX,
C.P. 03900, México
Tel: +52-55-5804-0600

BRAZIL

Yamaha Musical do Brasil Ltda.
Praça Professor José Lannes, 40, Cjs 21 e 22, Brooklin
Paulista Novo CEP 04571-100 – São Paulo – SP, Brazil
Tel: +55-11-3704-1377

ARGENTINA

**Yamaha Music Latin America, S.A.,
Sucursal Argentina**
Olga Cossetini 1553, Piso 4 Norte,
Madero Este-C1107CEK,
Buenos Aires, Argentina
Tel: +54-11-4119-7000

PANAMA AND OTHER LATIN AMERICAN/CARIBBEAN REGIONS

Yamaha Music Latin America, S.A.
Edif. Torre Banco General, Piso 7, Urbanización
Marbella, Calle 47 y Aquilino de la Guardia,
Ciudad de Panamá, República de Panamá
Tel: +507-269-5311

EUROPE

THE UNITED KINGDOM/IRELAND

Yamaha Music Europe GmbH (UK)
Sherbourne Drive, Tilbrook, Milton Keynes,
MK7 8BL, U.K.
Tel: +44-1908-366700

GERMANY

Yamaha Music Europe GmbH
Siemensstrasse 22-34, 25462 Rellingen, Germany
Tel: +49-4101-303-0

SWITZERLAND/LIECHTENSTEIN

**Yamaha Music Europe GmbH, Branch
Switzerland in Thalwil**
Seestrasse 18a, 8800 Thalwil, Switzerland
Tel: +41-44-3878080

AUSTRIA/BULGARIA/ CZECH REPUBLIC/HUNGARY/ ROMANIA/SLOVAKIA/SLOVENIA

**Yamaha Music Europe GmbH
Branch Austria**
Schleiergasse 20, 1100 Wien, Austria
Tel: +43-1-60203900

POLAND

**Yamaha Music Europe GmbH
Sp.z o.o. Oddział w Polsce**
ul. Wielicka 52, 02-657 Warszawa, Poland
Tel: +48-22-880-08-88

MALTA

Olimpus Music Ltd.
Valletta Road, Mosta MST9010, Malta
Tel: +356-2133-2093

NETHERLANDS/BELGIUM/ LUXEMBOURG

Yamaha Music Europe Branch Benelux
Clarissenhof 5b, 4133 AB Vianen, The Netherlands
Tel: +31-347-358040

FRANCE

Yamaha Music Europe
7 rue Ambroise Croizat, Zone d'activités de Pariest,
77183 Croissy-Beaubourg, France
Tel: +33-1-6461-4000

ITALY

Yamaha Music Europe GmbH, Branch Italy
Via Tinelli N.67/69 20855 Gemo di Lesmo (MB),
Italy
Tel: +39-039-9065-1

SPAIN/PORTUGAL

**Yamaha Music Europe GmbH Ibérica, Sucursal en
España**
Ctra. de la Coruña km. 17,200, 28231
Las Rozas de Madrid, Spain
Tel: +34-91-639-88-88

GREECE

Philippos Nakas S.A. The Music House
19th km. Leof. Lavriou 190 02 Peania – Attiki,
Greece
Tel: +30-210-6686168

SWEDEN/FINLAND/ICELAND

**Yamaha Music Europe GmbH Germany filial
Scandinavia**
JA Wettergrensgata 1, 400 43 Göteborg, Sweden
Tel: +46-31-89-34-00

DENMARK

**Yamaha Music Denmark,
Fillial of Yamaha Music Europe GmbH, Tyskland**
Generatorvej 8C, ST. TH. , 2860 Søborg, Denmark
Tel: +45-44-92-49-00

NORWAY

**Yamaha Music Europe GmbH Germany -
Norwegian Branch**
Grini Næringspark 1, 1332 Østerås, Norway
Tel: +47-6716-7800

CYPRUS

Yamaha Music Europe GmbH
Siemensstrasse 22-34, 25462 Rellingen, Germany
Tel: +49-4101-303-0

RUSSIA

Yamaha Music (Russia) LLC.
Room 37, entrance 7, bld. 7, Kievskaya street,
Moscow, 121059, Russia
Tel: +7-495-626-5005

OTHER EUROPEAN REGIONS

Yamaha Music Europe GmbH
Siemensstrasse 22-34, 25462 Rellingen, Germany
Tel: +49-4101-3030

AFRICA

Yamaha Music Gulf FZE
JAFZA-16, Office 512, P.O.Box 17328,
Jebel Ali FZE, Dubai, UAE
Tel: +971-4-801-1500

MIDDLE EAST

TURKEY

**Yamaha Music Europe GmbH
Merkezi Almanya Türkiye İstanbul Şubesi**
Mor Sumbul Sokak Varyap Meridian Business 1.Blok
No:1 113-114-115
Bati Atasehir Istanbul, Turkey
Tel: +90-216-275-7960

OTHER REGIONS

Yamaha Music Gulf FZE
JAFZA-16, Office 512, P.O.Box 17328,
Jebel Ali FZE, Dubai, UAE
Tel: +971-4-801-1500

ASIA

THE PEOPLE'S REPUBLIC OF CHINA

Yamaha Music & Electronics (China) Co.,Ltd.
2F, Yunhedasha, 1818 Xinzha-lu, Jingan-qu,
Shanghai, China
Tel: +86-400-051-7700

INDIA

Yamaha Music India Private Limited
P-401, JMD Megapolis, Sector-48, Sohna Road,
Gurugram-122018, Haryana, India
Tel: +91-124-485-3300

INDONESIA

PT Yamaha Musik Indonesia Distributor
Yamaha Music Center Bldg. Jalan Jend. Gatot Subroto
Kav. 4, Jakarta 12930, Indonesia
Tel: +62-21-520-2577

KOREA

Yamaha Music Korea Ltd.
11F, Prudential Tower, 298, Gangnam-daero,
Gangnam-gu, Seoul, 06253, Korea
Tel: +82-2-3467-3300

MALAYSIA

Yamaha Music (Malaysia) Sdn. Bhd.
No.8, Jalan Perbandaran, Kelana Jaya, 47301
Petaling Jaya, Selangor, Malaysia
Tel: +60-3-78030900

SINGAPORE

Yamaha Music (Asia) Private Limited
Block 202 Hougang Street 21, #02-00,
Singapore 530202, Singapore
Tel: +65-6740-9200

TAIWAN

Yamaha Music & Electronics Taiwan Co.,Ltd.
2F., No.1, Yuandong Rd., Banqiao Dist.,
New Taipei City 22063, Taiwan (R.O.C.)
Tel: +886-2-7741-8888

THAILAND

Siam Music Yamaha Co., Ltd.
3, 4, 15, 16th Fl., Siam Motors Building,
891/1 Rama 1 Road, Wangmai,
Pathumwan, Bangkok 10330, Thailand
Tel: +66-2215-2622

VIETNAM

Yamaha Music Vietnam Company Limited
15th Floor, Nam A Bank Tower, 201-203 Cach Mang
Thang Tam St., Ward 4, Dist.3,
Ho Chi Minh City, Vietnam
Tel: +84-8-3818-1122

OTHER ASIAN REGIONS

<http://asia.yamaha.com/>

OCEANIA

AUSTRALIA

Yamaha Music Australia Pty. Ltd.
Level 1, 80 Market Street, South Melbourne,
VIC 3205, Australia
Tel: +61-3-9693-5111

REGIONS AND TRUST TERRITORIES IN PACIFIC OCEAN

<http://asia.yamaha.com/>

Head Office/Manufacturer: Yamaha Corporation 10-1, Nakazawa-cho, Naka-ku, Hamamatsu, 430-8650, Japan

Importer (European Union): Yamaha Music Europe GmbH Siemensstrasse 22-34, 25462 Rellingen, Germany

Importer (United Kingdom): Yamaha Music Europe GmbH (UK) Sherbourne Drive, Tilbrook, Milton Keynes, MK7 8BL, United Kingdom

PA57

Yamaha Pro Audio global website
<http://www.yamahaproaudio.com/>

Yamaha Downloads
<https://download.yamaha.com/>

Manual Development Group
© 2013 Yamaha Corporation
Published 07/2021
POMA-DO

VFH2210