



TX-396L

Natural Sound AM/FM Stereo Tuner

Syntonisateur AM/FM stéréo de la série "Natural Sound"

OWNER'S MANUAL
MODE D'EMPLOI
BEDIENUNGSANLEITUNG
BRUKSANVISNING
MANUALE DI ISTRUZIONI
MANUAL DE INSTRUCCIONES
GEBRUIKSAANWIJZING

SUPPLIED ACCESSORIES
ACCESSOIRES FOURNIS
MITGELIEFERTE ZUBEHÖRTEILE
MEDFÖLJANDE TILLBEHÖR
ACCESSORI IN DOTAZIONE
ACCESORIOS INCLUIDOS
BIJGELEVERDE ACCESSOIRES

- After unpacking, check that the following parts are contained.
- Après le déballage, vérifiez que les pièces suivantes sont incluses.
- Nach dem Auspacken überprüfen, ob die folgenden Teile vorhanden sind.
- Kontrollera efter det apparaten packats upp att följande delar finns med.
- Verificare che tutte le parti seguenti siano contenute nell'imballaggio dell'apparecchio.
- Desembalar el aparato y verificar que los siguientes accesorios están en la caja.
- Controleer na het uitpakken of de volgende onderdelen voorhanden zijn.

- Indoor FM Antenna
- Antenne FM intérieure
- UKW-Innenantenne
- FM inomhusantenn
- Antenna FM per interni
- Antena FM interior
- FM Binnenantenne

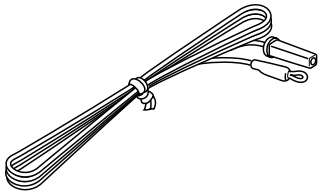

- AM Loop Antenna
- Cadre-antenne AM
- MW-Rahmenantenne
- AM ramantenn
- Antenna AM ad anello
- Antena de cuadro de AM
- AM Lusantenne

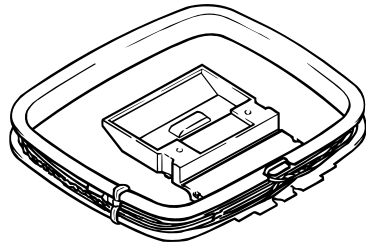

- Audio connection cord
- Câble de connexion audio
- Audio-Anschlußkabel
- Audio anslutningsladdar
- Cavo di collegamento audio
- Cable de conexión de audio
- Audio aansluitkabel

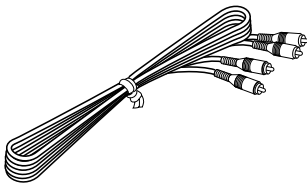

- 75-ohm/300-ohm antenna adapter (U.K. model only)
- Adaptateur d'antenne 75 ohms/300 ohms (Modèle Royaume-Uni seulement)
- 75-Ohm/300-Ohm Antennenstecker (nur Großbritannien-Modell)
- 75 ohm/300 ohm antennadapter (gäller endast modellerna för Storbritannien)
- Adattatore per antenna da 75 e 300 ohm (Soltanto il modello per la Gran Bretagna)
- Adaptador de antena de 75-ohmios/300-ohmios (Sólo el modelo para el Reino Unido)
- 75 ohm/300 ohm antenneadapter (Alleen modellen voor Verenigd Koninkrijk)

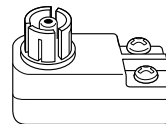

FEATURES

- 40 Station Random Access Preset Tuning
- Automatic Preset Tuning
- Multi-Status Station Memory
- Direct PLL Synthesizer Tuning
- Preset Station Shifting Capability (Preset Editing)

CONTENTS

Caution.....	1
Connections.....	2
Controls and Their Functions.....	5
Tuning Operations.....	7
Preset Tuning.....	8
Troubleshooting.....	11
Specifications.....	12

CAUTION: READ THIS BEFORE OPERATING YOUR UNIT.

1. This unit is a sophisticated stereo tuner. To assure proper operation and the best possible performance, please read this manual carefully.
2. Choose the installation location for the unit carefully. Avoid placing it in direct sunlight or close to a source of heat. Also avoid locations subject to vibration and excessive dust, heat, cold or moisture. Keep it away from such sources of hum as transformers or motors.
3. Do not open the cabinet, because this may result in damage to the unit or electrical shock. If a foreign object should get into the unit, contact your local dealer.
4. When not planning to use this unit for long periods of time (ie., vacation, etc.), disconnect the AC power plug from the wall outlet.
5. To prevent lightning damage, disconnect the AC power plug and disconnect the antenna cable when there is an electrical storm.
6. When disconnecting the power plug from the wall outlet, always pull directly on the plug; never pull the cord itself.
7. Do not use force when operating switches and other controls.
8. When moving the unit, be sure to first disconnect the power plug and disconnect all wires connected from the unit to other equipment.
9. Do not attempt to clean this unit with chemical solvents, because this may damage the finish. Use a clean, dry cloth.
10. Be sure to read the "TROUBLESHOOTING" section of this manual for advice on common operating errors before concluding that the unit is faulty.
11. Keep this manual in a safe place for future reference.

IMPORTANT

Please record the serial number of this unit in the space below.

Serial No.:

The serial number is located on the rear of the unit. Retain this Owner's Manual in a safe place for future reference.

WARNING

TO REDUCE THE RISK OF FIRE OR ELECTRIC SHOCK, DO NOT EXPOSE THIS APPLIANCE TO RAIN OR MOISTURE.

The apparatus is not disconnected from the AC power source as long as it is connected to the wall outlet, even if the apparatus itself is turned off.

For U.K. customers

If the socket outlets in the home are not suitable for the plug supplied with this appliance, it should be cut off and an appropriate 3 pin plug fitted. For details, refer to the instructions described below.

Note: The plug severed from the mains lead must be destroyed, as a plug with bared flexible cord is hazardous if engaged in a live socket outlet.

Special Instructions for U.K. Model

IMPORTANT

THE WIRES IN THE MAINS LEAD ARE COLOURED IN ACCORDANCE WITH THE FOLLOWING CODE:

Blue: NEUTRAL

Brown: LIVE

The colours of the wires in the mains lead of this apparatus may not correspond with the coloured markings identifying the terminals in your plug. Proceed as follows: the wire which is coloured BLUE must be connected to the terminal which is marked with the letter N or coloured BLACK. The wire which is coloured BROWN must be connected to the terminal which is marked with the letter L or coloured RED. Making sure that neither core is connected to the earth terminal of the three pin plug.

CONNECTIONS

Never plug in this unit and other components until all connections are completed.

ANTENNA CONNECTIONS

- Each antenna should be connected to the designated terminals correctly, referring to the following figure.
- Both AM and FM indoor antennas are included with this unit. In general, these antennas will probably provide sufficient signal strength. Nevertheless, a properly installed outdoor antenna will give clearer reception than an indoor one. If you experience poor reception quality, an outdoor antenna may result in improvement.

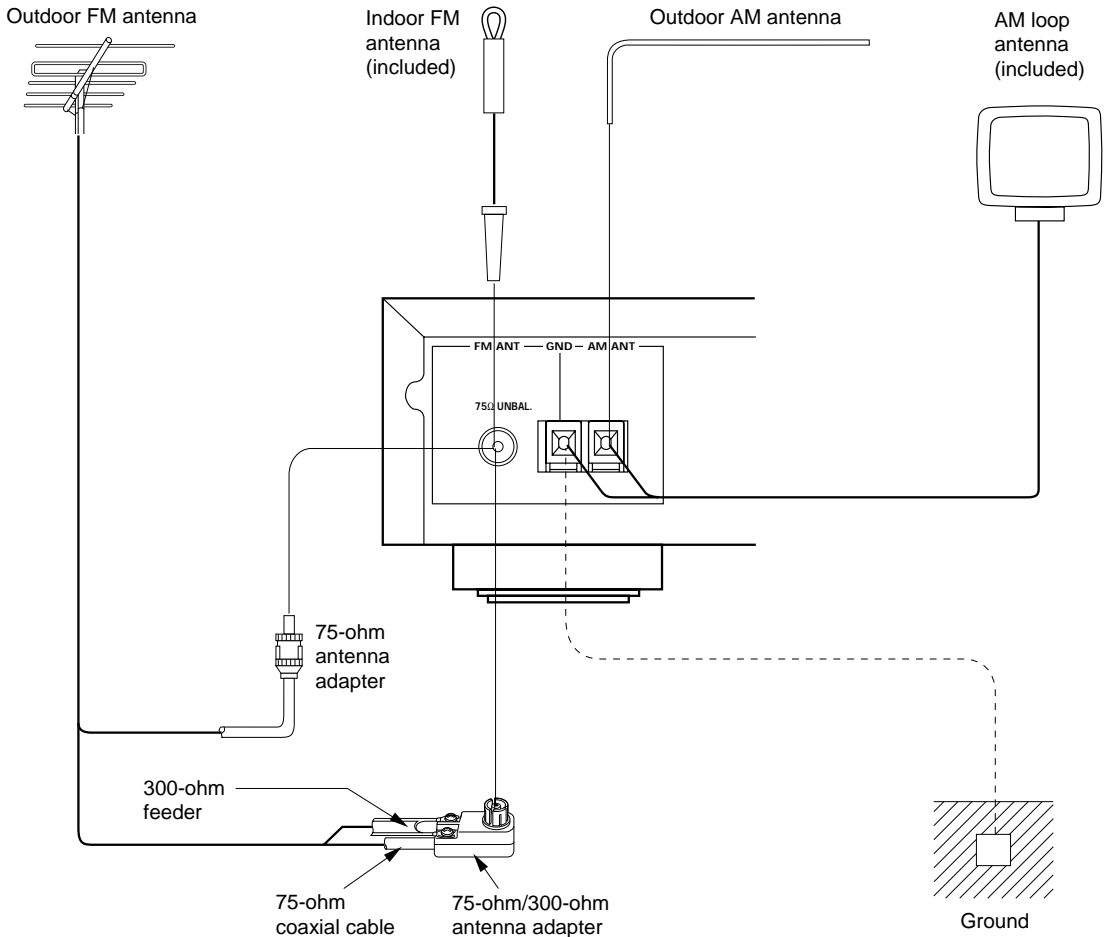

Connecting the indoor FM antenna

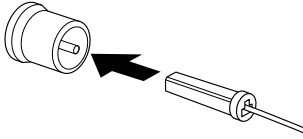

Connecting the AM loop antenna

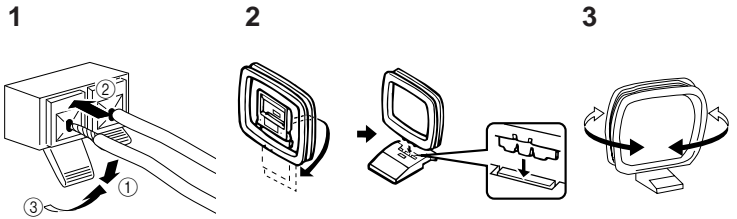

Orient so that the best reception is obtained.

Connecting a coaxial cable to the included 75-ohm/300-ohm antenna adapter

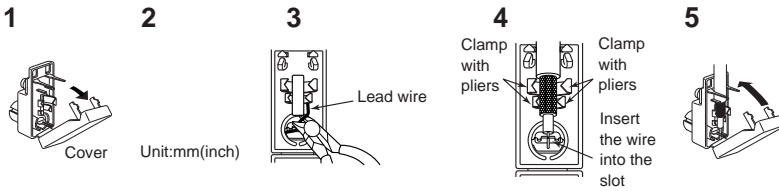

- 1 Open the cover of the included 75-ohm/300-ohm antenna adapter.
- 2 Cut the external sleeve of the 75-ohm coaxial cable and prepare it for connection.
- 3 Cut the lead wire and remove it.
- 4 Insert the cable wire into the slot, and clamp it with pliers.
- 5 Snap the cover into place.

- * If you connect an outdoor FM antenna to this unit, do not connect the indoor FM antenna to this unit.
- * The AM loop antenna should be placed apart from the main unit. The antenna may be hung on a wall.
- * The AM loop antenna should be kept connected, even if an outdoor AM antenna is connected to this unit.

Optional outdoor FM antenna

Consult with your dealer or authorized service center about the best method of selecting and erecting an outdoor FM antenna. The choice of the feeder cable is also important. Flat ribbon-shaped twin-lead cable performs well electrically, and is cheaper and somewhat easier to handle when routing it through windows and around rooms. Coaxial cable is more expensive, does a much better job of minimizing interference, is less prone to the effects of weather and close-by metal objects, and is nearly as good a signal conductor as feeder cable, particularly for foam-type coaxial cables. Coaxial cable is somewhat more difficult to install at the point where the cable enters the building. If coaxial cable is selected, make sure the antenna is designed to be used with that type of cable.

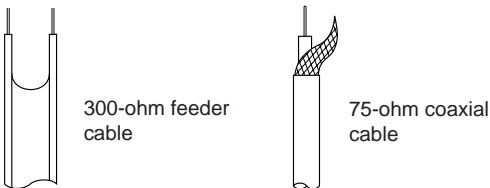

* Use a 75-ohm/300-ohm antenna adapter or a 75-ohm antenna adapter (not included) for connections.

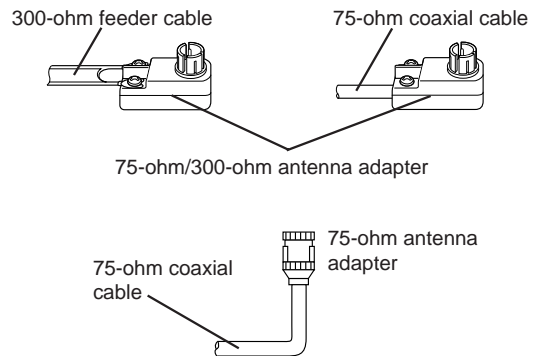

Notes for FM antenna installation

- To minimize automobile ignition noise, locate the antenna as far from heavy traffic as possible.
- Keep the feeder cable or coaxial cable as short as possible. Do not bundle or roll up excess cable.
- The antenna should be at least two meters (6.6 feet) from reinforced concrete walls or metal structures.

Optional outdoor AM antenna

In steel buildings or at a great distance from the transmitter, it may be necessary to install an outside long wire antenna.

GND terminal

For maximum safety and minimum interference, connect the **GND** terminal to a good earth ground. A good earth ground is a metal stake driven into moist earth.

CONNECTIONS TO THE AMPLIFIER

- Before making any connections, switch OFF the power to this unit and the amplifier or other component.
- Be sure that the connections from the left ("L") and right ("R") LINE OUT terminals are connected to the corresponding (left and right) input terminals of the amplifier or other component.
- If you have a YAMAHA amplifier whose terminals on the rear panel are numbered as 1, 2, 3, etc., connections can be made easily by making sure to connect the LINE OUT terminals of this unit to the input terminals of the amplifier numbered 2.

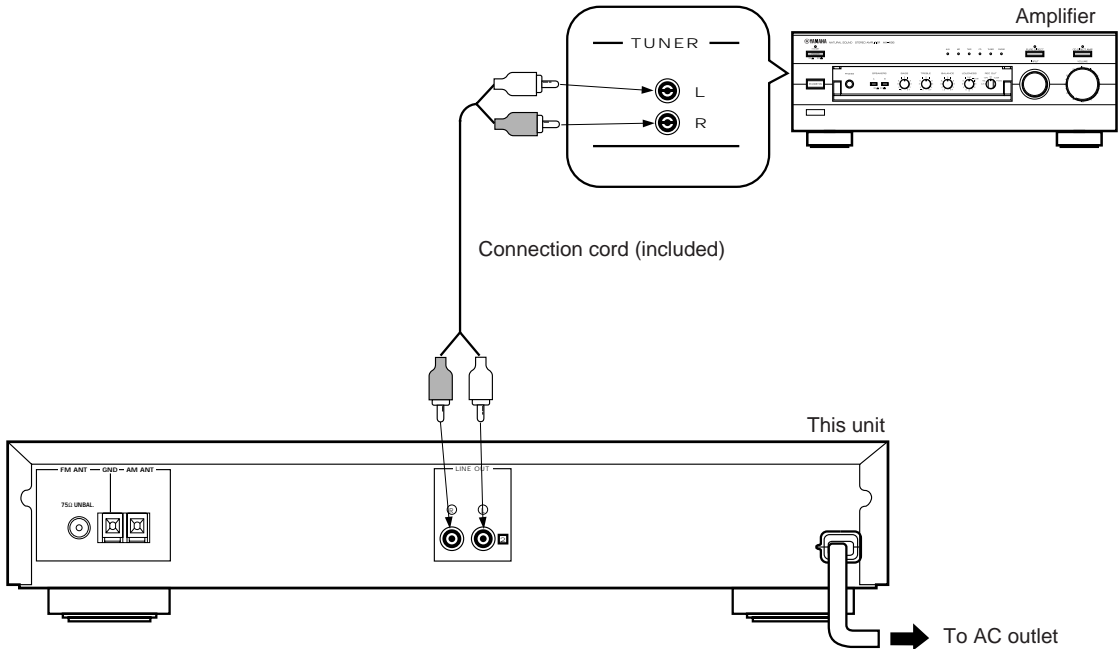

NOTES ABOUT CONTROLLING THIS UNIT WITH THE REMOTE CONTROL TRANSMITTER

This unit has a remote control sensor. It receives signals from a remote control transmitter provided with a YAMAHA amplifier or receiver.

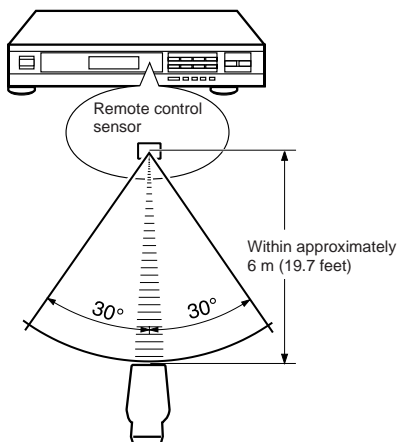

Notes

- There should be no large obstacles between the remote control transmitter and the main unit.
- If the remote control sensor is directly illuminated by strong lighting (especially an inverter type of fluorescent lamp etc.), it might cause the remote control transmitter not to work correctly. In this case, reposition the main unit to avoid direct lighting.

CONTROLS AND THEIR FUNCTIONS

FRONT PANEL

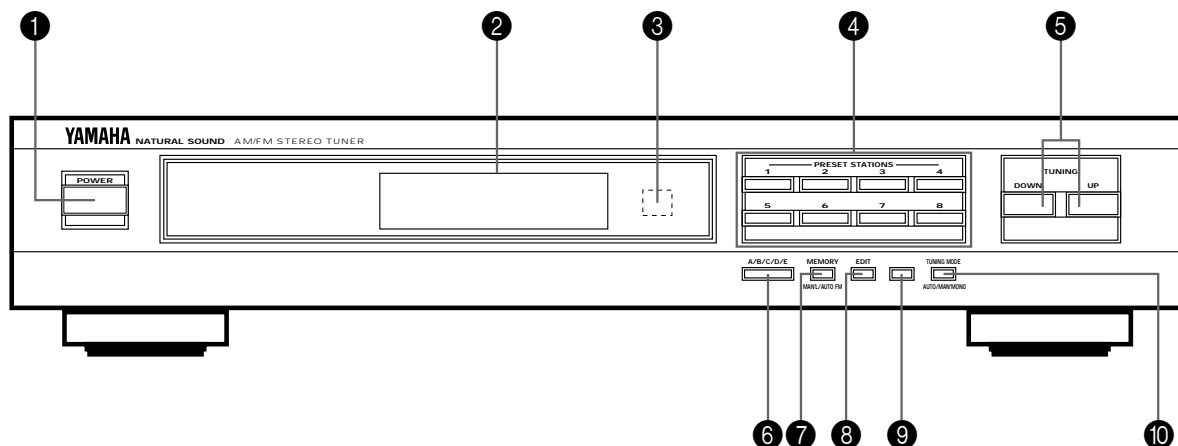

1 POWER switch

Press this switch to switch the power on. Press it again to switch the power off.

2 Display panel

Shows station frequencies and various information. (Refer to the next page for details.)

3 Remote control sensor

Receives signals from a remote control transmitter provided with a YAMAHA amplifier or receiver.

4 PRESET STATIONS buttons

Select a preset station number (1 to 8).

5 TUNING DOWN and UP buttons

Used for tuning. Press the "UP" button to tune in to higher frequencies, and press the "DOWN" button to tune in to lower frequencies.

6 A/B/C/D/E button

Press this button to select a desired group (A–E) of preset stations.

7 MEMORY (MAN'L/AUTO FM) button

When this button is pressed, the MEMO indicator flashes for about 5 seconds. During this period, press the desired **PRESET STATIONS** button to enter the displayed station into the memory.

When this button is pressed and held for about 3 seconds, the automatic preset tuning begins. (Refer to page 9 for details.)

8 EDIT button

This button is used to exchange the places of two preset stations with each other.

9 FM/MW/LW button

Press this button to switch the reception band to FM, MW or LW.

10 TUNING MODE (AUTO/MAN'L MONO) button

Press this button to switch the tuning mode to automatic or manual. To select the automatic tuning mode, press this button so that "AUTO" lights up on the display. To select the manual tuning mode, press this button so that "AUTO" goes off.

DISPLAY PANEL

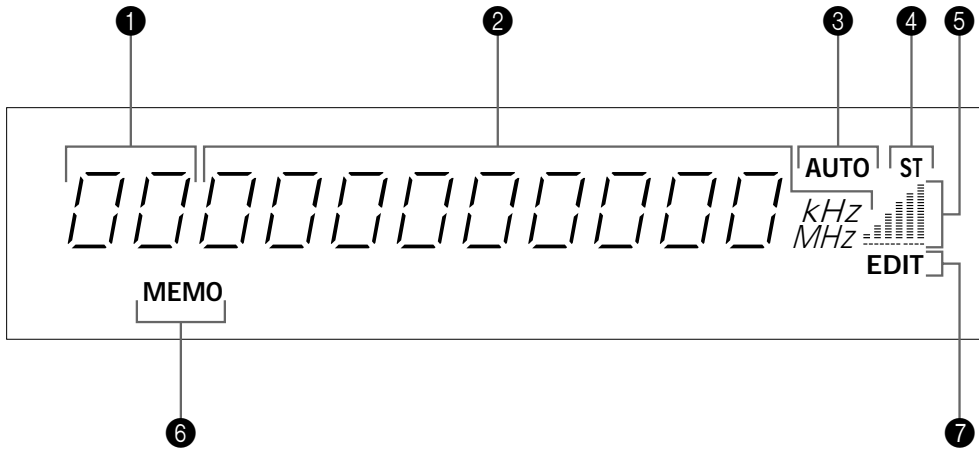

① Preset station indicator

Display the group (A/B/C/D/E) and the number (1 to 8) of a preset station.

② Station frequency display

Displays the band and frequency or information from the received station.

③ AUTO indicator

Lights up when this unit is in the automatic tuning mode.

④ ST (STEREO) indicator

Lights up when an FM stereo broadcast with sufficient signal strength is received.

⑤ Signal-level meter

Indicates the signal level of the received station. If multipath interference is detected, the indication decreases.

⑥ MEMO indicator

When the **MEMORY** button is pressed, this indicator flashes for about 5 seconds. During this period, the displayed station can be programmed to the memory by using the **A/B/C/D/E** button and one of the **PRESET STATIONS** buttons.

⑦ EDIT indicator

Flashes by the first press of the **EDIT** button when you will exchange preset stations, and lights up for a moment by the second press of the **EDIT** button to show that the exchange has succeeded.

TUNING OPERATIONS

Normally, if station signals are strong and there is no interference, quick automatic-search tuning (AUTOMATIC TUNING) is possible. However, if signals of the station you want to select are weak, you must tune to it manually (MANUAL TUNING).

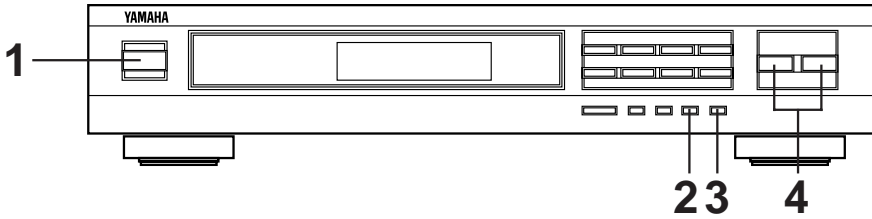

AUTOMATIC TUNING

- 1** Turn the power on.
- 2** Select the reception band confirming it on the display.
- 3**
- 4**

To tune to a higher frequency, press the UP button.
To tune to a lower frequency, press the DOWN button.

 - * If the station where tuning search stops is not the desired one, press again.
 - * If the tuning search does not stop at the desired station (because the signals of the station are weak), change to the MANUAL TUNING method.

MANUAL TUNING

- 1** Turn the power on.
- 2** Select the reception band confirming it on the display.
- 3**

Turn "AUTO" off.
- 4** Tune to a desired station manually.

* To continue tuning search, press and hold the button.

Notes

- If you tune to an FM station manually, it is received in monaural mode automatically to increase the signal quality.

PRESET TUNING

MANUAL PRESET TUNING

This unit can store station frequencies selected by tuning operation. With this function, you can recall any desired station by only selecting the preset station number where it is stored. Up to 40 stations (8 stations x 5 groups) can be stored.

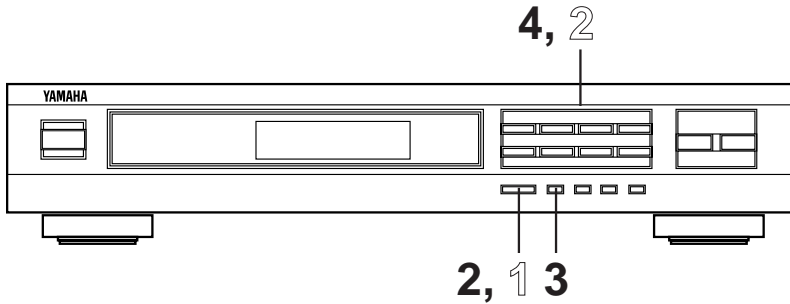

To store stations

1 Tune to a desired station.
(Refer to the previous page for tuning procedure.)

2 Select a desired group (A – E) of preset stations confirming it on the display.



3 Press the MEMORY button. The display shows "MEMO" and flashes on and off for about 5 seconds.



4 Select a preset station number where you want to program the station before "MEMO" goes off from the display.

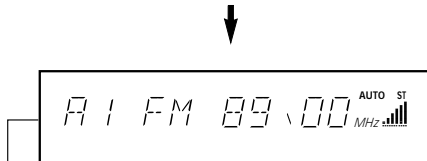
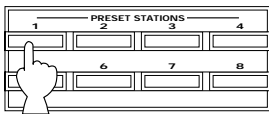

Shows the displayed station has been programmed to A1.

- * In the same way, program other stations to A2, A3 ... A8.
- * You can program more stations to preset station numbers on other groups in the same way by selecting other groups in step 2.

To recall a preset station

1 Select the group of preset stations.



2 Select the preset station number.

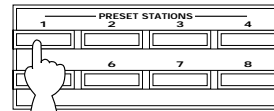

Notes

- A new setting can be programmed in place of the former one.
- For presets, the setting of the reception mode (stereo or monaural) is stored along with the station frequency.

Memory back-up

The memory back-up circuit prevents the programmed data from being lost even if the **POWER** switch is set off or the power plug is disconnected from the AC outlet or the power is cut due to temporary power failure. If, however, the power is cut for more than one week, the memory may be erased. If so, it can be re-programmed by simply following the PRESET TUNING steps.

AUTOMATIC PRESET TUNING

You can also make use of an automatic preset tuning function for FM stations only. By this function, this unit performs automatic tuning and stores FM stations with strong signals sequentially. Up to 40 stations are stored automatically in the same way as in the manual preset tuning method on page 8.

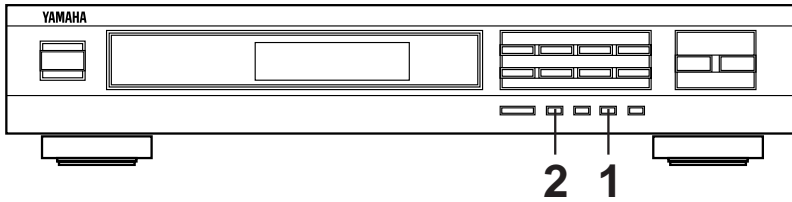

To store stations

1

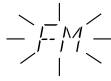

2



Press and hold for about 3 seconds.

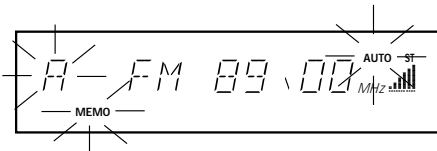

Flashes.

The automatic preset tuning begins from the frequency currently displayed. Received stations are programmed to A1, A2 ... A8 sequentially.

* If more than 8 stations are received, they are also programmed to the preset station numbers on other groups (B, C, D and E) in that order.

When the automatic preset tuning is finished

The display shows the frequency of the last preset station. Check the contents and the number of preset stations by following the procedure of the section "To recall a preset station" on page 8.

To recall a preset station

Simply follow the procedure of the section "To recall a preset station" on page 8.

Notes

- If no station is received by the automatic preset tuning search, the search finishes after "NOTHING" flashes for about 3 seconds on the display.
- You can replace a preset station by another FM, MW or LW station manually by simply following the procedure of the section "To store stations" on page 8.
- The automatic preset tuning search will be performed through all FM frequencies until stations are stored up to E8. If the number of received stations is not enough to be stored up to E8, the search is finished automatically after searching all frequencies.
- With this function, only FM stations with sufficient signal strength are stored automatically. If the station you want to program is weak in signal strength, tune in to it with the MANUAL TUNING method (in monaural) and program it by following the procedure of the section "To store stations" on page 8.

EXCHANGING PRESET STATIONS

You can exchange the places of two preset stations with each other as shown below.

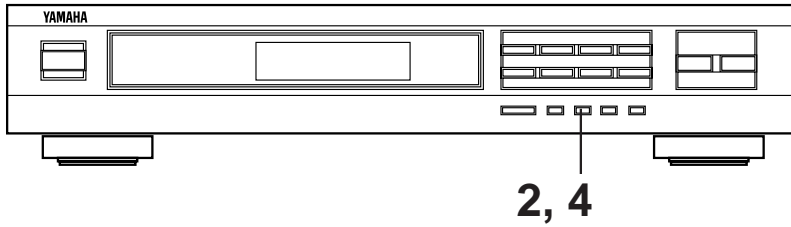

Example)

If you want to shift the preset station on E1 to A5, and vice versa.

1 Recall the preset station on E1 (by following the method of "To recall a preset station" on page 8).

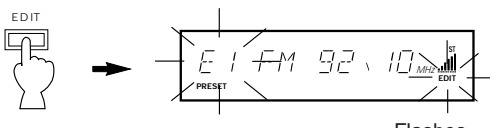
2  Flashes.

3 Next, recall the preset station on A5 by following the same method with step 1.

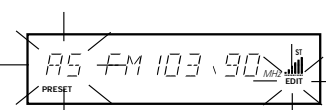
 Flashes.

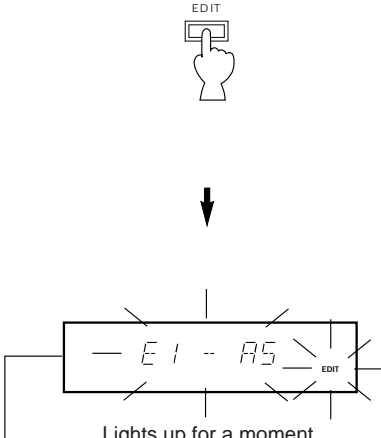
4  Lights up for a moment.

Shows the exchange of stations is completed.

TROUBLESHOOTING

If the unit fails to operate normally, check the following points to determine whether the fault can be corrected by the simple measures suggested. If it cannot be corrected, or if the fault is not listed in the SYMPTOM column, disconnect the power cord and contact your authorized YAMAHA dealer or service center for help.

	SYMPTOM	CAUSE	REMEDY
FM	Crackling sounds from time to time (especially in weak signal areas).	Ignition noise from passing vehicles.	The FM antenna should be put up as high as possible, away from the road, and a coaxial cable used.
		Noise from thermostats or other electrical equipment.	Attach a noise suppressor to the equipment causing the noise.
	FM stereo reception is noisy.	Because of the characteristics of FM stereo broadcasts, this is limited to cases where the transmitter is far away or the antenna input is poor.	Check the antenna connections. Try using a high quality directional FM antenna. Set the TUNING MODE button to the manual tuning mode.
	The ST indicator flickers and reception is noisy.	Insufficient antenna input.	Use an antenna appropriate for the reception condition in your area.
		Not tuned correctly.	Tune again.
	There is distortion and clear reception cannot be obtained even with a good FM antenna.	There is multipath interference.	Adjust antenna placement to eliminate multipath interference.
	No stereo effect even with a stereo broadcast.	The TUNING MODE button is set to the manual tuning mode.	Set the button so that "AUTO" lights up on the display.
AM (MW/LW)	A desired station cannot be tuned in with Automatic tuning.	The station is too weak.	Use the manual tuning mode. Use a high quality directional FM antenna.
	Previously preset stations can no longer be tuned in.	The tuner has been unplugged for a long period.	Repeat the presetting procedure.
	Insufficient sensitivity.	Weak signal or loose antenna connections.	Tighten the AM loop antenna connections and rotate it for best reception.
			Use the manual tuning mode.
	There are continuous crackling and hissing noises.	These noises result from lightning, fluorescent lamps, motors, thermostats and other electrical equipment.	Use an outdoor antenna and a ground wire. This will help somewhat but it is difficult to eliminate all noises.
	There are buzzing and whining noises (especially in the evening).	Another station is interfering with the received station.	This is impossible to remedy.
		A television set is being used nearby.	Relocate this unit away from the TV.

SPECIFICATIONS

FM SECTION

Tuning Range	87.5 to 108 MHz
Usable Sensitivity (DIN)	
75 ohms Mono (S/N 26 dB)	0.9 μ V
75 ohms Stereo (S/N 46 dB)	24 μ V
Selectivity (two signals, 40 kHz Dev., \pm 300 kHz)	
.....	70 dB
Signal-to-Noise Ratio (DIN-Weighted)	
Mono (40 kHz Dev.)	75 dB
Stereo (40 kHz Dev.)	70 dB
Harmonic Distortion (1 kHz) (40 kHz Dev.)	
Mono/Stereo	0.1%/0.2%
Stereo Separation (1 kHz) (40 kHz Dev.)	50 dB
Frequency Response	
20 Hz to 15 kHz	0 \pm 1.5 dB

AM (MW) SECTION

Tuning Range	531 to 1,611 kHz
Usable Sensitivity	200 μ V/m
Harmonic Distortion; 1 kHz	0.3%

AM (LW) SECTION

Tuning Range	153 to 288 kHz
Usable Sensitivity	400 μ V/m
Signal-to-Noise Ratio	50 dB
Harmonic Distortion; 1 kHz	0.3%

AUDIO SECTION

Output Level	
FM (100 % mod. 1 kHz) (40 kHz Dev.)	500 mV
AM (30% mod. 1 kHz)	200 mV

GENERAL

Power Supply	230V, 50 Hz
Power Consumption	7W
Dimensions (W x H x D)	435 x 86 x 278 mm (17-1/8" x 3-3/8" x 10-15/16")
Weight	3.2 kg (7 lbs. 1 oz.)
Accessories	Audio connection cord AM loop antenna Indoor FM antenna

* Specifications subject to change without notice.



YAMAHA ELECTRONICS CORPORATION, USA 6660 ORANGETHORPE AVE., BUENA PARK, CALIF. 90620, U.S.A.
YAMAHA CANADA MUSIC LTD. 135 MILNER AVE., SCARBOROUGH, ONTARIO M1S 3R1, CANADA
YAMAHA ELECTRONIK EUROPA G.m.b.H. SIEMENSSTR. 22-34, 25462 RELINGEN BEI HAMBURG, F.R. OF GERMANY
YAMAHA ELECTRONIQUE FRANCE S.A. RUE AMBROISE CROIZAT BP70 CROISSY-BEAUBOURG 77312 MARNE-LA-VALLEE CEDEX02, FRANCE
YAMAHA ELECTRONICS (UK) LTD. YAMAHA HOUSE, 200 RICKMANSWORTH ROAD WATFORD, HERTS WD1 7JG, ENGLAND
YAMAHA SCANDINAVIA A.B. J. A. WETTERGRENS GATA 1, BOX 30053, 400 43 VÄSTRA FRÖLINDA, SWEDEN
YAMAHA MUSIC AUSTRALIA PTY, LTD. 17-33 MARKET ST., SOUTH MELBOURNE, 3205 VIC., AUSTRALIA

YAMAHA CORPORATION
V490720