

DD-14

DIGITAL PERCUSSION

Owner's Manual

YAMAHA

Using an optional Power Adapter
The DD-14 also features a socket which can play with a nine channel PCM source, from an audio tape or a CD-ROM drive. A manual is included with the unit to help you set up the DD-14 to use the optional power adapter. The DD-14 is compatible with the following power adapters: PA-3, PA-4, PA-5, PA-6, PA-7, PA-8, PA-9, PA-10, PA-11, PA-12, PA-13, PA-14, PA-15, PA-16, PA-17, PA-18, PA-19, PA-20, PA-21, PA-22, PA-23, PA-24, PA-25, PA-26, PA-27, PA-28, PA-29, PA-30, PA-31, PA-32, PA-33, PA-34, PA-35, PA-36, PA-37, PA-38, PA-39, PA-40, PA-41, PA-42, PA-43, PA-44, PA-45, PA-46, PA-47, PA-48, PA-49, PA-50, PA-51, PA-52, PA-53, PA-54, PA-55, PA-56, PA-57, PA-58, PA-59, PA-60, PA-61, PA-62, PA-63, PA-64, PA-65, PA-66, PA-67, PA-68, PA-69, PA-70, PA-71, PA-72, PA-73, PA-74, PA-75, PA-76, PA-77, PA-78, PA-79, PA-80, PA-81, PA-82, PA-83, PA-84, PA-85, PA-86, PA-87, PA-88, PA-89, PA-90, PA-91, PA-92, PA-93, PA-94, PA-95, PA-96, PA-97, PA-98, PA-99, PA-100.

1. Controls and Connectors	2
2. The Demonstration Songs	4
3. Manual Percussion	5
3.1 The Super Session Player	5
3.2 Percussion Set Selection	6
3.3 Custom Percussion Sets	7
3.4 The Auto Roll Function	9
3.5 The Scraper	9
4. Auto Accompaniment	10
4.1 The Auto Bass Chord Function	10
4.2 Accompaniment Style Selection	10
4.3 The Tempo Setting	10
4.4 Setting the Tempo with Tap	10
4.5 Accompaniment Control	10
4.6 Minus One Accompaniment	10

Congratulations!

... on your purchase of a Yamaha DD-14 Digital Percussion unit. The DD-14 is a portable electronic percussion unit packed with features that make it fun and exciting to play, whether you use it as a practice drum set or an instrument in its own right. These features include:

● **Seventy-five PCM instrument sounds**

The DD-14 has 65 real-sounding percussion sounds and sound effects which you can assign to any of the eight velocity-sensitive percussion pads or the foot pedal, plus ten melody percussion voices which you can assign to the pads to play tunes along with the Auto Accompaniment.

● **Thirty percussion sets**

The instruments are grouped into thirty percussion sets that make it easy to select the right instruments for the music you're playing. There are even five user areas that you can use to save your own customized percussion sets.

● **Automatic rhythm response**

A handy Auto Roll function automatically plays smooth rolls, flams, and echoes that will dress up your performance.

● **Super Session Player**

The Super Session Player function will respond to the notes you play with unpredictable sounds and phrases. You'll have lots of fun dueling with the DD-14 in ad-lib jam sessions!

● **Nine scraper instruments**

The DD-14 also features a scraper which can play any of nine different PCM sounds, from an auto harp to a multi drum, to a guiro, or guitar.

● **Automatic rhythm section with 100 styles**

The DD-14 has an automatic rhythm section which plays one hundred different rhythm styles, complete with intros, endings, and fill-ins. In addition, an Auto Bass Chord function provides a bass line and rhythmic chords matching the rhythm style you select.

● **Tap Start function**

You can start the automatic rhythm section playing at the desired tempo with a four count using the convenient Tap Start Function.

● **Three-song Chord Memory**

You can combine the automatic rhythm section and Auto Bass Chord functions by playing chord sequences that the DD-14 will remember as songs. You can use the Chord Memory feature DD-14 to record up to three songs, then play along with them on the percussion pads when you play them back.

● **MIDI implementation**

You can hook the DD-14 up to other digital instruments, such as synthesizers or drum machines, using the MIDI terminals on the instrument's rear panel.

Contents

1. Controls and Connectors	2
2. The Demonstration Songs	4
3. Manual Percussion	
3.1 The Super Session Player	5
3.2 Percussion Set Selection	6
3.3 Custom Percussion Sets	7
3.4 The Auto Roll Function	9
3.5 The Scraper	9
4. Auto Accompaniment	
4.1 The Auto Bass Chord Function	10
4.2 Accompaniment Style Selection	10
4.3 The Tempo Setting	10
4.4 Setting the Tempo with Tap Start	11
4.5 Accompaniment Controls and Variations ...	11
4.6 Minus One Accompaniment	12

5. The Chord Memory	
5.1 Realtime Recording	12
5.2 Step Recording	13
5.3 Playback	14
6. MIDI	15
MIDI Implementation Chart	17
Troubleshooting	18
Specifications	19

Taking Care of Your DD-14

Your DD-14 Digital Percussion unit will give you years of playing pleasure if you follow the simple rules below.

1. Avoid placing the DD-14 in areas that are subject to excessive heat or humidity. Do not leave the instrument near heaters or in a car exposed to direct sunlight, for example.
2. Avoid locations where the instrument is likely to be exposed to excessive dust or moisture.
3. Make any connections between the DD-14 and other devices with both pieces of equipment turned off. Lower the volume on all devices to the minimum level when turning the power on.
4. Do not subject the instrument to strong physical shocks, and avoid placing any heavy objects on top of it.
5. Use a soft cloth, dry or slightly damp, to clean the DD-14. Never use chemicals such as benzine or thinner.
6. The DD-14 contains digital circuitry which may cause interference if it is placed close to radio or television receivers. If this occurs, move the instrument farther away from the affected receiver.

Supplying Power to the DD-14

Your DD-14 Digital Percussion unit will operate on either batteries or an optional power adaptor. Follow the instructions below for the power source you intend to use.

Using batteries:

Open the battery compartment cover located on the bottom of the DD-14 and insert six "C" size (SUM-2 or R-14) batteries or equivalent (sold separately), being careful to orient them as shown by the markings inside the compartment. Then replace the battery compartment cover, making sure that it locks firmly in place.

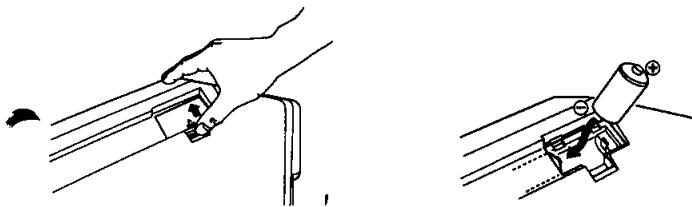

Cautions:

- When the batteries run down, replace them with a complete set of six new batteries. NEVER mix old and new batteries.
You will know it is time to replace the batteries with fresh ones when the following symptoms occur:
 1. The DD-14's instrument sounds become distorted.
 2. The DD-14 resets its settings to their initial values for no apparent reason.
- To prevent damage due to battery leakage, remove the batteries from the instrument when it is not to be used for an extended period of time.

Using an optional Power Adaptor:

Plug the DC output cable from an Yamaha PA-3, PA-4, or PA-40 Power Adaptor into the DC IN jack on the DD-14 rear panel, then plug the adaptor into a convenient AC power outlet.

Use **ONLY** a Yamaha PA-3, PA-4, or PA-40 Power Adaptor to power your DD-14 with AC mains power. Other AC adaptors could cause serious damage to your Digital Percussion unit.

1. Controls and Connectors

Control Panel

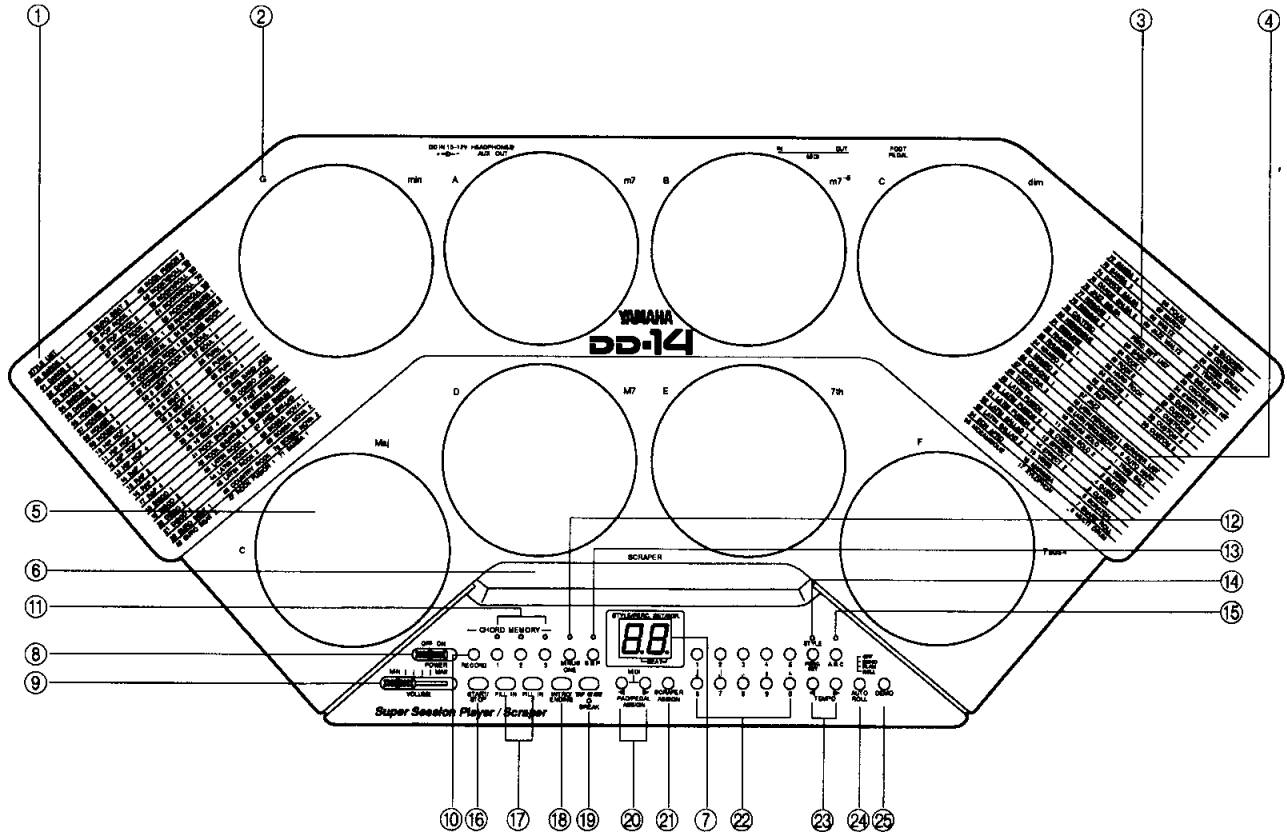

- | | |
|--|------------------------------------|
| ① STYLE LIST | ⑭ STYLE/PERCUSSION SET button |
| ② Chord symbols | ⑮ AUTO BASS CHORD (A.B.C.) button |
| ③ PERCUSSION SET LIST | ⑯ START/STOP button |
| ④ SCRAPER LIST | ⑰ FILL IN buttons |
| ⑤ Percussion pads | ⑱ INTRO/ENDING button |
| ⑥ Scraper | ⑲ TAP START/BREAK button |
| ⑦ Display | ⑳ PAD/PEDAL ASSIGN ◀ and ▶ buttons |
| ⑧ POWER switch | ㉑ SCRAPER ASSIGN button |
| ⑨ VOLUME control | ㉒ Number buttons |
| ⑩ CHORD MEMORY RECORD button | ㉓ TEMPO ◀ and ▶ buttons |
| ⑪ CHORD MEMORY PLAY buttons | ㉔ AUTO ROLL button |
| ⑫ MINUS ONE button | ㉕ DEMO button |
| ⑬ SUPER SESSION PLAYER (S.S.P.) button | |

Rear Panel

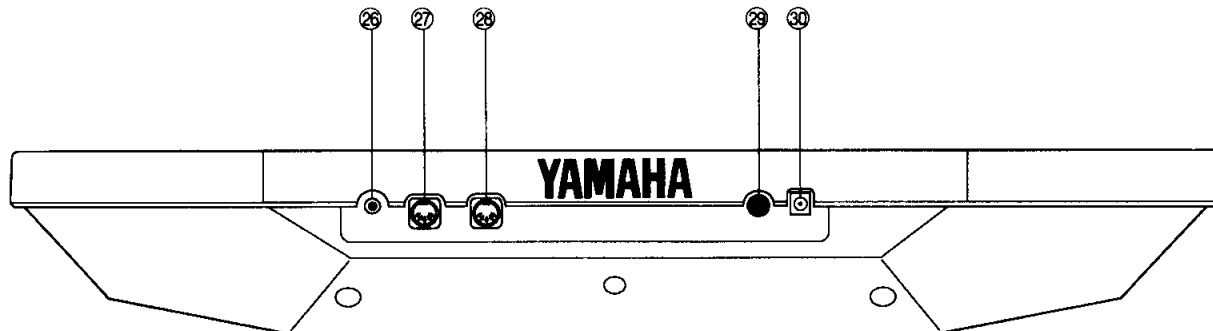

- ②⑥ FOOT PEDAL jack
- ②⑦ MIDI OUT terminal
- ②⑧ MIDI IN terminal
- ②⑨ HEADPHONES/AUX. OUT jack
- ③⑩ DC IN jack (10--12 volts)

Using Headphones or an External Sound System

You can plug a standard pair of stereo headphones into the HEADPHONES/AUX. OUT jack ②⑨ for private practice or late-night playing. The DD-14's built-in speakers will turn off automatically when you plug in your headphones.

You can also use the HEADPHONES/AUX. OUT jack to send the output from the DD-14 to a keyboard amplifier, stereo sound system, mixing console, or tape recorder. Use a stereo audio cable to connect the DD-14 to an external sound system.

Supplied Accessories

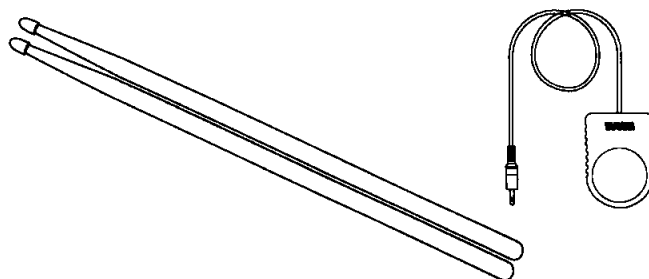

The Yamaha DD-14 Digital Percussion unit is accompanied by a pair of percussion sticks and a foot pedal that plugs into the FOOT PEDAL jack ②⑥ on the rear panel.

The percussion sticks have been designed specifically for use with the DD-14, and should not be used to play acoustic drums or to strike any surface other than the percussion pads ⑤. Also, please do not strike the percussion pads with any object other than the supplied sticks or your bare hands.

2. The Demonstration Songs

The DD-14 is programmed with two demonstration songs that let you hear many of its features in action. Follow the steps below to play the demo songs.

1. Slide the POWER switch ⑧ to the ON position.

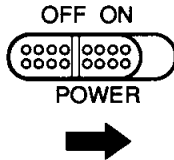

2. Set the VOLUME control ⑨ to a position about half way between the MIN and MAX settings. You can make further volume adjustments after you start the demonstration.

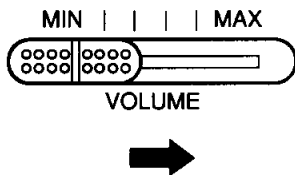

3. Press the DEMO button ⑫ to start the demonstration. All of the two demo songs will play in turn, repeating continuously until you stop them. If you wish, you can play along with the demo songs by tapping on the DD-14 percussion pads ⑤.



4. You can stop the demonstration at any time by pressing either the DEMO button ⑫ or the START/STOP button ⑬.

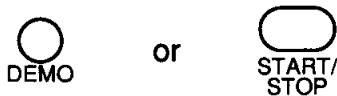

Playing individual demo songs

When you first press and hold the DEMO button ⑫, the message "dA" will appear in the display ⑦ to indicate that the DD-14 is going to play all two of the demo songs.



You don't have to listen to all two of the songs if you don't want to, however. To select only one song, try tapping on one of the percussion pads ⑤ before you release the DEMO button.

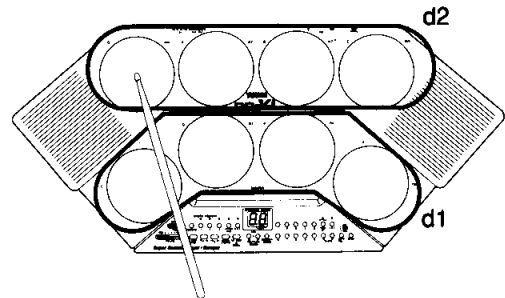

The pads correspond to songs as shown in the illustration above. When you tap a pad, the "A" in the display will be replaced by a number from 1 to 2 corresponding to the number of the song to be played.

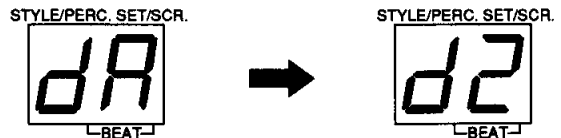

The song you select will start playing as soon as you release the DEMO button.

3. Manual Percussion

You can start playing the DD-14 as soon as you turn the POWER switch ⑧ ON and raise the VOLUME control ⑨ to an appropriate level. Play the percussion pads ⑤ with the supplied percussion sticks or your hands. The scraper ⑥ is played by running the tip of a percussion stick or a finger back and forth across its length. Finally, play the foot pedal by tapping on it with the toes of your foot.

Initial Instrument Assignments

Whenever you turn the POWER switch ⑧ on, the following instruments will be assigned to the percussion pads ⑤, the scraper ⑥, and the foot pedal:

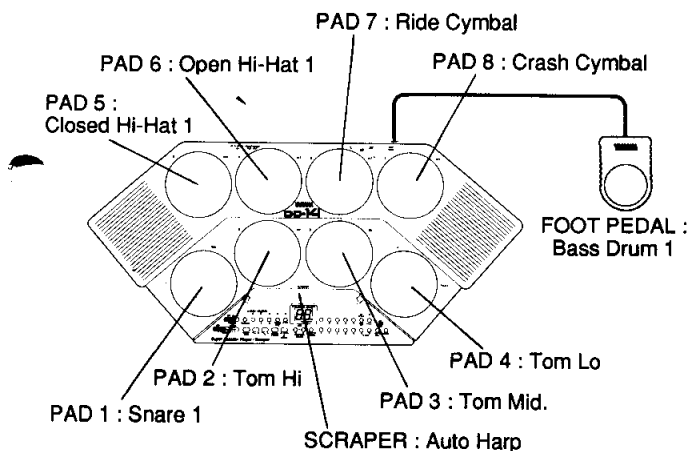

The pad and pedal assignments above correspond to percussion set 00 (BASIC), which is one of the 30 different percussion sets you can choose from. (The selection of percussion sets is described in the next section.)

Pad Sensitivity

The percussion pads ⑤ are equipped with touch sensors so that they respond just like acoustic percussion instruments: the harder you play, the louder the sound. Be careful not to hit the pads too hard, though. Once the maximum volume is reached, it will not be possible to produce any more volume by striking the pads harder. The use of unnecessary force in playing the percussion pads can damage the instrument and cause spurious triggering of unwanted sounds.

If you wish, you can change the pad sensitivity level to suit your playing style. To decrease the sensitivity, turn the POWER switch ⑧ off, then turn it on again while holding down the PAD/PEDAL ASSIGN ◀ button. Release the PAD/PEDAL ASSIGN ◀ button when the word "Lo" appears in the display.

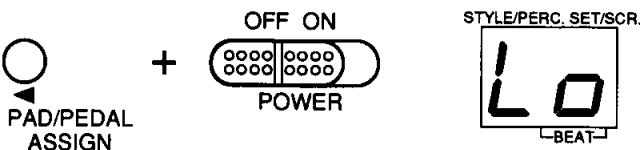

To increase the sensitivity, turn the POWER switch on while holding down the PAD/PEDAL ASSIGN ▶ button. Release the PAD/PEDAL ASSIGN ▶ button when the word "Hi" appears in the display ⑦.

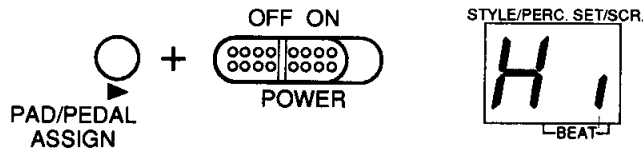

Your DD-14 was set to play with this sensitivity level when it left the Yamaha factory. Please note that the sensitivity of the pedal and the scraper ⑥ will not be affected by this setting. The DD-14 will remember your sensitivity setting even when the power is turned off.

3.1 The Super Session Player

Each time you turn on the power to the DD-14, the indicator above the SUPER SESSION PLAYER button ⑬ will light. This means that the Super Session Player function has been activated.



If you've already tried playing the percussion pads ⑤, you probably have a good idea what this function does. When the Auto Accompaniment is turned off, the DD-14 answers the notes you play with sounds of its own. The response you get depend partly on how many times you hit the pads, and partly on how hard you hit them. The DD-14 may play a sound effect, a Super Session Player pattern, or even echo the notes you played. If you play a particularly long solo, the Super Session Player will answer you with a hearty round of applause.

If you use the Super Session Player function together with the Auto Accompaniment, the DD-14 will respond to your notes by adding Super Session Player patterns or temporarily dropping instruments from the rhythm style that's playing. These rhythm variations help make your sessions with the Auto Accompaniment even more dynamic and exciting. You can turn the Super Session Player function on and off as desired by pressing the Super Session Player button ⑬.

3.2 Percussion Set Selection

The DD-14 has thirty different percussion sets that you can select to match your musical requirements. Each set assigns different instruments (or melody percussion notes) to the DD-14's percussion pads ⑤ and foot pedal. The pad and pedal assignments for each percussion set are listed below. (The names of these sets are also listed in the PERCUSSION SET LIST ③ in the upper right panel of the control panel.)

No.	SET NAME	PAD 5 PAD 1	PAD 6 PAD 2	PAD 7 PAD 3	PAD 8 PAD 4	PEDAL
00	BASIC SET	17 Closed Hi-Hat 1 04 Snare 1	18 Open Hi-Hat 1 12 Tom Hi	24 Ride Cymbal 11 Tom Mid.	21 Crash Cymbal 10 Tom Lo	00 Bass Drum 1
01	ROCK SET 1	17 Closed Hi-Hat 1 05 Snare 2	38 Tambourine 12 Tom Hi	37 Cabasa 11 Tom Mid.	21 Crash Cymbal 10 Tom Lo	00 Bass Drum 1
02	ROCK SET 2	17 Closed Hi-Hat 1 04 Snare 1	37 Cabasa 09 Rim Shot	24 Ride Cymbal 15 E. Tom 1 Hi	22 Splash Cymbal 13 E. Tom 1 Lo	00 Bass Drum 1
03	HARD ROCK SET	36 Cowbell 07 Snare 4	18 Open Hi-Hat 1 12 Tom Hi	23 Ride Cup 11 Tom Mid.	21 Crash Cymbal 10 Tom Lo	01 Bass Drum 2
04	DANCE SET 1	17 Closed Hi-Hat 1 05 Snare 2	18 Open Hi-Hat 1 08 Snare 5	38 Tambourine 11 Tom Mid.	21 Crash Cymbal 03 Bass Drum 4	02 Bass Drum 3
05	DANCE SET 2	17 Closed Hi-Hat 1 06 Snare 3	35 Hand Claps 07 Snare 4	23 Ride Cup 16 E. Tom 2	21 Crash Cymbal 00 Bass Drum 1	01 Bass Drum 2
06	RAP SET	19 Closed Hi-Hat 2 05 Snare 2	20 Open Hi-Hat 2 08 Snare 5	38 Tambourine 57 "Woo"	22 Splash Cymbal 02 Bass Drum 3	03 Bass Drum 4
07	JAZZ SET	22 Splash Cymbal 04 Snare 1	24 Ride Cymbal 12 Tom Hi	23 Ride Cup 11 Tom Mid.	21 Crash Cymbal 10 Tom Lo	17 Closed Hi-Hat 1
08	LATIN PERCUSSION SET 1	32 Agogo Hi 34 Cuica Hi	31 Agogo Lo 28 Timbale Lo	36 Cowbell 29 Timbale Hi	22 Splash Cymbal 38 Tambourine	00 Bass Drum 1
09	LATIN PERCUSSION SET 2	42 Guiro (Long) 27 Conga Mute	41 Guiro (Short) 26 Conga Hi	36 Cowbell 25 Conga Lo	37 Cabasa 30 Claves	35 Hand Claps
10	DRUM SOLO SET 1	22 Splash Cymbal 18 Open Hi-Hat 1	12 Tom Hi 05 Snare 2	11 Tom Mid. 10 Tom Lo	21 Crash Cymbal 00 Bass Drum 1	00 Bass Drum 1
11	DRUM SOLO SET 2	22 Splash Cymbal 18 Open Hi-Hat 1	12 Tom Hi 07 Snare 4	11 Tom Mid. 10 Tom Lo	21 Crash Cymbal 13 E. Tom Lo	01 Bass Drum 2
12	CYMBAL SET	21 Crash Cymbal 17 Closed Hi-Hat 1	24 Ride Cymbal 19 Closed Hi-Hat 2	23 Ride Cup 18 Open Hi-Hat 1	22 Splash Cymbal 20 Open Hi-Hat 2	63 Sound Effect 6
13	EFFECT SET 1	62 Sound Effect 5 52 Car Horn	60 Sound Effect 3 39 Finger Snap	56 Scratch 54 Dropping Coin	59 Sound Effect 2 57 "Woo"	61 Sound Effect 4
14	EFFECT SET 2	49 Cat 58 Sound Effect 1	48 Dog 53 Buzzer	51 Jungle 64 Applause	55 Water 43 Bell Tree	50 Lion
15	VIBES (C3 - C4)					
16	MARIMBA (C3 - C4)					
17	XYLOPHONE (C4 - C5)	G	A	B	C	
18	GLOCKEN (C4 - C5)					
19	CELESTA (C3 - C4)					#
20	STEEL DRUM (C3 - C4)					
21	TIMPANI (C1 - C2)					
22	BELLS (C4 - C5)	C	D	E	F	
23	ORCHESTRA HIT (C3 - C4)					
24	SYNTH HIT (C3 - C4)					
25	CUSTOM SET 1	User Memory Area				
26	CUSTOM SET 2					
27	CUSTOM SET 3					
28	CUSTOM SET 4					
29	CUSTOM SET 5					

1. Check to make sure that the indicator above the STYLE/PERCUSSION SET button (14) is not lit. If it is lit, press the STYLE/PERCUSSION SET button. The indicator will go out, and the number of the current percussion set will appear in the display (7).



Note: Percussion set 00 (BASIC) is automatically selected each time you turn the POWER switch (8) on.

2. Use the number buttons (2) to enter the number of the desired percussion set (00 through 29).

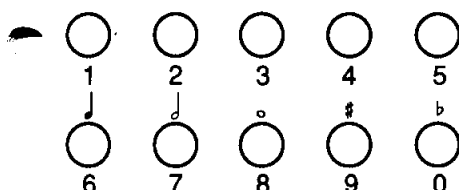

Always enter two digits to select a percussion set. For example, to select set 03 (HARD ROCK), press the "0" button and then the "3" button. The new set will be selected as soon you enter the second digit of its number.

3.3 Custom Percussion Sets

The DD-14 allows you to assign any of its 75 instrument sounds to any of the percussion pads (5). In addition, you can assign any of the non-melody percussion instruments (00 through 64) to the foot pedal.

You can also assign the functions normally performed by the FILL IN buttons (17) and the INTRO/ENDING button (18) to any of the percussion pads or the foot pedal. The functions of these buttons are explained fully in the following chapter.

The DD-14 lets you create and store up to five different percussion sets at any one time. You can store the sets you create as the sets labeled CUSTOM 1 through CUSTOM 5 (sets 25 through 29). The DD-14 will keep your custom sets in its memory even when the power is turned off.

The instruments and functions available for assignment are listed in the chart below, as well as on the Instrument List card which accompanied this manual.

NO.	INSTRUMENT	NO.	INSTRUMENT
00	Bass Drum 1	38	Tambourine
01	Bass Drum 2	39	Finger Snap
02	Bass Drum 3	40	Cross Sticks
03	Bass Drum 4	41	Guero (Short)
04	Snare 1	42	Guero (Long)
05	Snare 2	43	Bell Tree
06	Snare 3	44	"One"
07	Snare 4	45	"Two"
08	Snare 5	46	"Three"
09	Rim Shot	47	"Four"
10	Tom Lo	48	Dog
11	Tom Mid.	49	Cat
12	Tom Hi	50	Lion
13	E.Tom 1 Lo	51	Jungle
14	E.Tom 1 Mid.	52	Car Horn
15	E.Tom 1 Hi	53	Buzzer
16	E.Tom 2	54	Dropping Coin
17	Closed Hi-Hat 1	55	Water
18	Open Hi-Hat 1	56	Scratch
19	Closed Hi-Hat 2	57	"Woo"
20	Open Hi-Hat 2	58	Sound Effect 1
21	Crash Cymbal	59	Sound Effect 2
22	Splash Cymbal	60	Sound Effect 3
23	Ride Cup	61	Sound Effect 4
24	Ride Cymbal	62	Sound Effect 5
25	Conga Lo	63	Sound Effect 6
26	Conga Hi	64	Applause
27	Conga Mute	65	Vibes
28	Timbale Lo	66	Marimba
29	Timbale Hi	67	Xylophone
30	Claves	68	Glockenspiel
31	Agogo Lo	69	Celesta
32	Agogo Hi	70	Steel Drum
33	Cuica Lo	71	Timpani
34	Cuica Hi	72	Bells
35	Hand Claps	73	Orchestra Hit
36	Cowbell	74	Synth. Hit
37	Cabasa		

1. Using the method described in the Section 3.2, select the percussion set (25 through 29) where you wish to store your assignments. If you select any other set, your assignments will not be saved.



- Select one of the percussion pads ⑥ to which you will assign the new instrument. Tap the pad once.

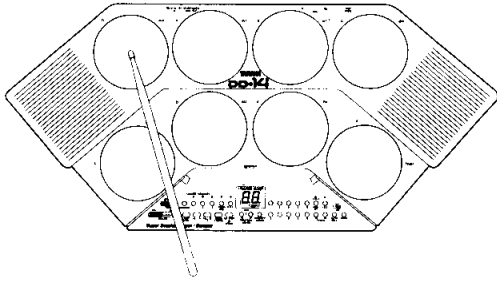

- Press one of the PAD/PEDAL ASSIGN buttons ⑩. The number of the instrument which is currently assigned to the pad you've selected will appear in the display ⑦ while you're pressing the button.



- Now press and hold whichever of the PAD/PEDAL ASSIGN buttons corresponds to the direction in which you want to move through the instrument list. If you can get to the instrument you want most quickly by moving backward from the current instrument, for example, press and hold the PAD/PEDAL ASSIGN ◀ button.



- While holding the appropriate PAD/PEDAL ASSIGN button, tap the pad you've selected repeatedly. With each tap you will hear the sound of the next instrument in the direction you've selected (◀ or ▶), and the number of that instrument will appear in the display.

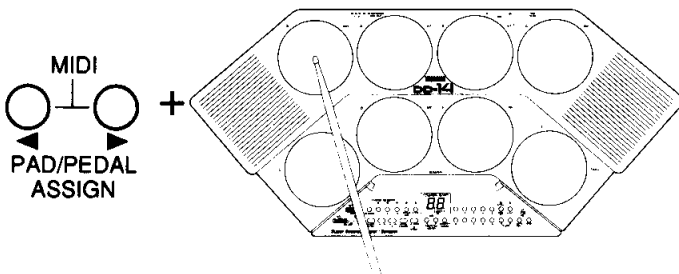

If you wish, you can simply enter the number of an instrument instead of tapping the pad repeatedly. To do so, press and hold either of the PAD/PEDAL ASSIGN buttons, tap the pad you've selected once, then enter the number of the desired instrument using the number buttons ⑫. (Be sure to enter two digits.)

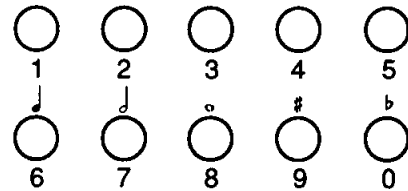
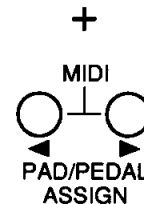
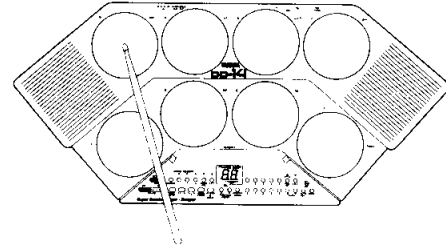

- Release the PAD/PEDAL ASSIGN button immediately after you hear the instrument you want. The DD-14 will now play the newly assigned instrument whenever you play the pad in question.

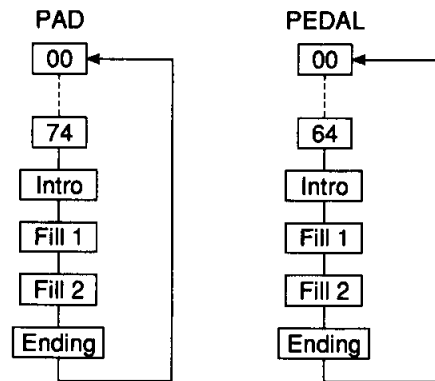



- Repeat steps 1 through 6 to assign new instruments to the other pads.

Note: The instructions above assume that you will be assigning an instrument to one of the percussion pads. The procedure for assigning an instrument (or function) to the foot pedal is exactly the same.

3.4 The Auto Roll Function

The DD-14 features a handy Auto Roll function which helps you dress up your performances with smooth echoes, flams, and rolls. Since the length and speed of each of these effects varies automatically to match the tempo, all you have to do is hit the first note with the right timing and the DD-14 will do the rest. Even novice percussionists can get slick, professional-sounding results every time.

1. Press the AUTO ROLL button  once. The current Auto Roll setting will appear in the display .



Note: The Auto Roll function is automatically turned off whenever you turn the POWER switch  on.

2. Press the AUTO ROLL button repeatedly to select the desired setting.



When you select the "echo" setting, the DD-14 will add to each note a series of eighth-note echoes that fade out over the space of a measure.



The "flam" setting produces turns every note you play into a flam (a double note).



When you select the "roll" setting, the DD-14 will produce a roll synchronized with the tempo each time you hit one of the pads  or the foot pedal.

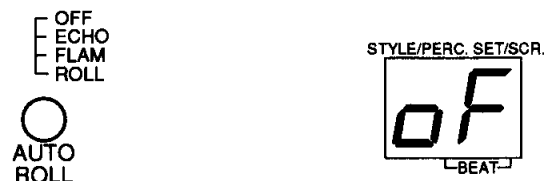

Pressing the AUTO ROLL button once more will turn the Auto Roll function off again.

3. The display will continue to show the new setting for a couple of seconds, then return to the previously displayed style or percussion set number.

Note: The Auto Roll function may at times produce only quiet or noise-like effects, depending on the instrument selection and tempo setting with which you use it.

3.5 The Scrapper

The DD-14's innovative scrapper adds a whole new range of sonic effects to its repertoire. You can play the scrapper by running the tip of a percussion stick or a finger back and forth across its length. (You might want to experiment with other playing techniques, such as tapping your fingers at intervals from right to left, or vice versa.)

You can assign one of nine different instrument sounds to the scrapper using the method described below. The scrapper assignment is independent of the percussion set selection, and will not change even if you select a new percussion set.

1. Press the SCRAPER ASSIGN button  once. The current scrapper instrument selection will appear in the display .



Note: Scrapper "0" (AUTO HARP) is automatically selected whenever you turn the POWER switch  on.

2. Press the SCRAPER ASSIGN button repeatedly to select the desired setting. The DD-14 will cycle through the nine possibilities, returning to "0" after it reaches "8".

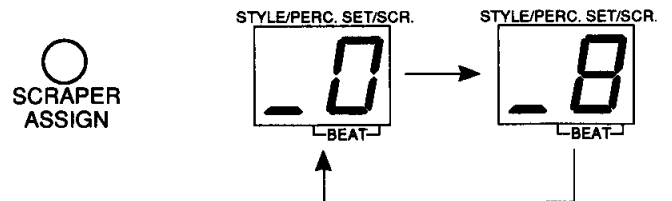

3. The display will continue to show the number of the new scrapper instrument for a couple of seconds, then return to the previously displayed style or percussion set number.

Note: Do not scratch the scrapper with your fingernails or hard objects, as doing so may damage the scrapper surface or cause the scrapper to become deformed.

4. Auto Accompaniment

The DD-14 is capable of accompanying you with 100 automatic rhythm styles covering an extremely wide range of musical genres. These styles are listed in the STYLE LIST ① which is divided between the right and left sides of the control panel. You can select and play back any of the styles, then play along with them using the manual percussion techniques described in the preceding chapter.

Try pressing the START/STOP button ⑯. The DD-14 will begin playing style 00 (DANCE 1), complete with a bass line and chord pattern. This style is automatically selected as the current accompaniment style each time you turn on the POWER switch ⑧. Once you start the Auto Accompaniment, it will keep playing until you stop it. You can do so by pressing the START/STOP button a second time.

4.1 The Auto Bass Chord Function

Each time you turn the DD-14's POWER switch ⑧ on, the indicator above AUTO BASS CHORD button ⑮ will light. This means that the Auto Bass Chord function has been activated.



If you've tried playing the Auto Accompaniment, you've probably got a pretty good idea of what the Auto Bass Chord function does. Basically, it adds a bass line and a chord pattern to the rhythm section, giving you a complete rhythm section to play along with. The added instruments play a preset chord progression that more or less matches the selected accompaniment style.

Of course, you don't have to use this chord progression if you don't want to. The Chord Memory function described in Chapter 5 lets you create your own songs, complete with chord progressions. Or if you'd prefer to perform with no sounds other than percussion, press the AUTO BASS CHORD button ⑮ to turn the Auto Bass Chord function off.



You can turn the function on and off as desired by simply pressing this button.

4.2 Accompaniment Style Selection

You can use the method below to select a different style using the method below at any time, even while the Auto Accompaniment is playing.

1. First, check to make sure that the indicator above the STYLE/PERCUSSION SET button ⑭ is lit. If not, press the STYLE/PERCUSSION SET button. The indicator will light and the number of the currently selected style will appear in the display ⑦.



Note: Style 00 (DANCE 1) is automatically selected each time you turn the POWER switch ⑧ on.

2. Use the number buttons ② to enter the number of the desired style (00 through 99).

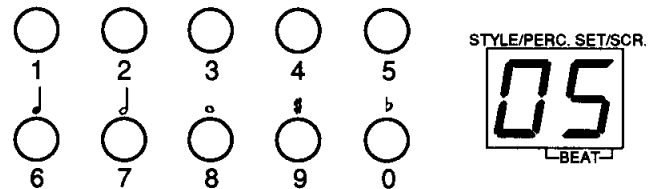

Always enter two digits to select an accompaniment style. For example, to select style 05 (DANCE 6), press the "0" button and then the "5" button. If the Auto Accompaniment is already playing, the new style will start to play at the beginning of the next measure after you enter the second digit of its number.

Automatic Percussion Set Selection

Whenever you select an accompaniment style while the MINUS ONE function (described on page 12) is turned on, the DD-14 will automatically select the percussion set most appropriate to that style.

4.3 The Tempo Setting

The two dots at the bottom of the display ⑦ flash in time with the Auto Accompaniment, providing you with a visual cue to the tempo. Both dots flash simultaneously on the first beat of the two-measure pattern; the left dot alone flashes on the first beat of the second measure; and the right dot flashes on all remaining beats.

When you select a four-beat pattern, for example, the dots will flash in the following sequence:

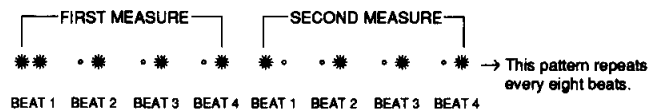

The range of available tempos runs from 40 to 280 beats per minute. You can change the current tempo setting within this range at any time, even while the Auto Accompaniment is playing, using the TEMPO buttons ⑳. Press the TEMPO ► button to increase the tempo, or the TEMPO ◀ button to decrease the tempo.

When you press one of the TEMPO buttons, the tens and ones digits of the current tempo will appear in the display ⑦. These digits will remain there for about a second after you release the TEMPO button. Thereafter, the display will show in quick succession the hundreds digit, followed again by the tens and ones digits, before it returns to normal.

When the tempo is set to 120 bpm, for example, you will see the following displays:

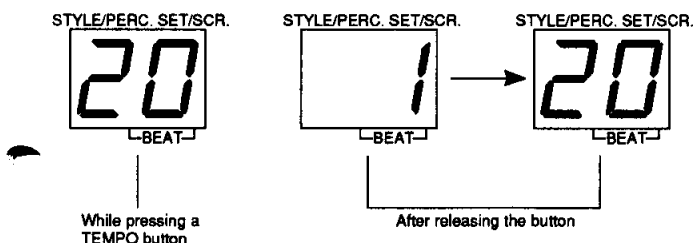

Each accompaniment style has a "normal" tempo value that you can recall at any time by pressing both the TEMPO ◀ and ► buttons simultaneously. Since style 00 (DANCE 1) is automatically selected when the POWER switch ⑧ is turned on, the tempo is automatically set to 140 beats per minute, the normal tempo for this style, at that time.

4.4 Setting the Tempo with Tap Start

another way to set the tempo, one which you can use when you start the Auto Accompaniment (rather than before or after). When you use the Tap Start function, the DD-14 will give you a count into the rhythm as you set the pace.

1. Begin by pressing the TAP START/BREAK button ⑲. The indicator below the button will begin to flash.



2. Tap any of the percussion pads ⑤ with a steady beat, using the tempo you want to play at. The DD-14 will count off "One, two, three, four!" (or a variation, depending on the time signature of the style you've selected), then start the Auto Accompaniment playing at the tempo you've set.
3. Start playing the pads. The indicator under the TAP START/BREAK button will go out automatically as soon as the Auto Accompaniment starts.

4.5 Accompaniment Controls and Variations

At the beginning of this chapter you learned how to start and stop the DD-14's Auto Accompaniment using the START/STOP button ⑯. Here are a few techniques that will allow you to play with a little more polish.

Starting with an Intro

You can start any of the accompaniment styles with an intro pattern by pressing the INTRO/ENDING button ⑱ instead of the START/STOP button ⑯.



Adding Fill-ins

To add a short fill-in pattern (rhythm variation) while the Auto Accompaniment is playing, press one of the two FILL IN buttons ⑳.



Breaking for a Fill-in

The Break function lets you pause the Auto Accompaniment so you can play your own fill-ins on the percussion pads ⑤. Press the TAP START/BREAK button ⑲ while the Auto Accompaniment is playing. The indicator below the button will light, indicating that the function has been activated.

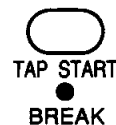

Now, whenever you hit one of the percussion pads, the Auto Accompaniment will stop playing for the rest of the measure, allowing you to play your own fill-in. It will start up again at the beginning of the next measure. Press the TAP START/BREAK button again when you want to turn the Break function off.

Stopping with Style

We described at the beginning of this chapter how you can stop the Auto Accompaniment instantly by pressing the START/STOP button ⑮. If you wish, you can stop it with a little more class by pressing the INTRO/ENDING button ⑱, instead.



If you press this button at the start or in the middle of a measure, the ending pattern will begin playing immediately. If you press it on or after the last beat of a measure, however, the ending pattern will start at the beginning of the next measure.

If you press the INTRO/ENDING button a second time while the ending pattern is playing, the DD-14 will add a ritardando, slowing the tempo gradually until the pattern ends.

4.6 Minus One Accompaniment

The last accompaniment function, known as Minus One, is a convenient feature that lets you play along with the DD-14 Auto Accompaniment without being upstaged by it. To use the function, press the MINUS ONE button ⑳.



The indicator above the button will light, indicating that the function has been activated. Also, the DD-14 will automatically change the percussion set selection to the set that is best suited to the rhythm style you've selected. Now, whenever you tap the pads to play an instrument which is also being used by the Auto Accompaniment, the Auto Accompaniment will stop playing that instrument for four measures, letting you take it instead. It will keep playing its other instruments, however, giving you a background to solo against.

The Minus One function is thus like a more advanced version of the Break function. Like that function, Minus One is useful for playing extended fills. In addition, however, you can use it while playing normally to thin out your rhythm sound, for a more authentic-sounding simulation of a real drum set. Be sure to try using the Minus One function in combination with the Auto Bass Chord function, too. This combination of functions will make for a sharp-sounding performance! Press the MINUS ONE button again when you want to turn the function off.

5. The Chord Memory

The Chord Memory feature allows you to record and play back songs which you create with the Auto Accompaniment and Auto Bass Chord functions. You can use this feature to record a complete accompaniment part, then play along with it on the percussion pads ⑤.

The DD-14 lets you record three songs, corresponding to the three CHORD MEMORY PLAY ⑪ buttons on the control panel. Each song can consist of up to 32 measures of chord change data, together with intro, fill-in, and ending pattern specifications. The contents of each song will be retained in the DD-14's memory for about one week, even when the power is turned off.

2. Set a tempo that will be easy to record at.
3. Press one of three the CHORD MEMORY PLAY buttons ⑪ corresponding to the song you want to record while holding the RECORD button ⑩. The indicator for the selected song will flash, indicating that the DD-14 is in record ready mode.

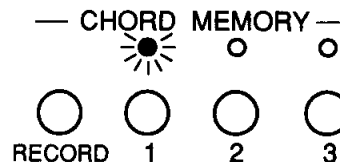

5.1 Realtime Recording

Realtime recording is basically recording on the fly. Since this method involves record songs as you play them, we recommend it especially to percussionists who have already gotten the hang of their DD-14.

1. Select an accompaniment style that is appropriate to the type of music you want to record.

Note: Be sure that the song you select does not contain song data you wish to keep. Any data already recorded for the song in question will be erased when the DD-14 enters record ready mode.

4. Press the START/STOP button ⑯ when you're ready to begin recording. The left dot in the display ⑦ will flash to indicate that the DD-14 is now recording.



You can press the INTRO/ENDING button ⑰ at this point if you want to begin the song with an intro pattern. (If you play a chord while the intro pattern is playing, the intro pattern will be backed by the Auto Bass Chord section during playback.) Otherwise, begin playing chords using the method described at the end of this section. As the recording progresses, the numbers in the display will change constantly to indicate the current measure and beat. The left digit is the ones digit of the current measure, while the right digit shows the beat.

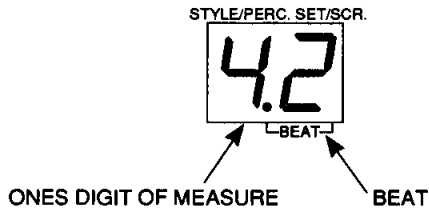

If you wish, you can press the FILL IN buttons ⑱ while recording to add fill-in patterns to your song; or you can press the BREAK button ⑲ to break for your own fills.

5. When you finish playing the chord sequence, press the START/STOP button, the INTRO/ENDING button, or the CHORD MEMORY PLAY button you selected to stop recording.

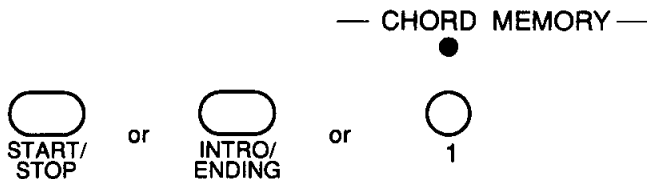

The DD-14 will sound a buzzer and stop recording if you exceed the song capacity of 32 measures.

Recording Chords in Realtime

The DD-14 will automatically activate the Auto Bass Chord function whenever it enters record ready mode. Strike the percussion pads ⑤ to play chords as you record, referring to the chord symbols ② next to the pads to determine which ones are appropriate.

You can play different types of chords by first hitting the pad corresponding to the root of the chord, and then quickly playing another pad corresponding to the desired chord type. Holding the foot pedal while playing a pad causes the chord for that pad to be sharpened (i.e., raised by a semitone). The available chord types and corresponding pads are listed in the table below.

PAD	FIRST STRIKE		SECOND STRIKE
	PAD ONLY	PEDAL + PAD	CHORD TYPE
PAD 1	C	C# (Db)	Major (M)
PAD 2	D	D# (Eb)	Major 7th (M7)
PAD 3	E	F	7th (7)
PAD 4	F	F# (Gb)	7th suspended 4 (7sus4)
PAD 5	G	G# (Ab)	Minor (m)
PAD 6	A	A# (Bb)	Minor 7th (m7)
PAD 7	B	C	Minor 7th flat 5 (m7 ^b 5)
PAD 8	C	C# (Db)	Diminished (dim)

To play a B minor chord, for example, you would play PAD 7 (B chord) and PAD 5 (minor) in rapid succession. When recording chords in realtime, try to hit chords just before the beat on which you want them to start. If you hit them on rather than before the beat, they will be recorded too late.

Any chords you play will continue until you play the next chord or stop the recording.

5.2 Step Recording

In addition to the realtime recording method described in the previous section, the DD-14 also allows you to use a step recording method. This method is rather more complex than realtime recording, but it allows you to specify chord changes with greater ease and accuracy.

1. Press the CHORD MEMORY PLAY button ⑩ for the song you want to record while holding the RECORD button ⑩. The indicator for the selected song will flash, indicating that the DD-14 is in record ready mode.

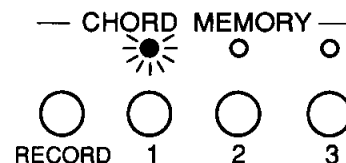

Note: Be sure that the song you select does not contain song data you wish to keep. Any data already recorded for the song in question will be erased when the DD-14 enters record ready mode.

2. Start recording. You can press the INTRO/ENDING button ⑮---preceded by a chord, if you so desire---to begin the song with an intro pattern. Otherwise, begin playing chords using the method described at the end of this section.

As you proceed with the recording, the numbers in the display will change constantly to indicate the measure and beat you are going to record next. The left digit is the ones digit of the measure, while the right digit shows the beat.

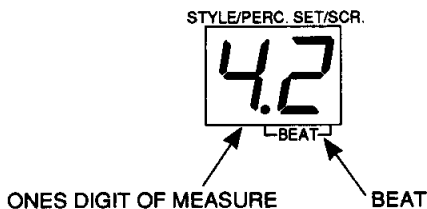

Be sure to record four beats for each measure, even when recording a song that is to be played with a three-beat patterns. The DD-14 will automatically ignore the fourth beat of every measure when it plays songs in 3/4 time.

3. When you finish playing the entire chord sequence, press the START/STOP button (or the CHORD MEMORY PLAY button you selected in step 1) to stop recording. You can also press the INTRO/ENDING button---preceded by a chord, if you wish---to end the song with an ending pattern.

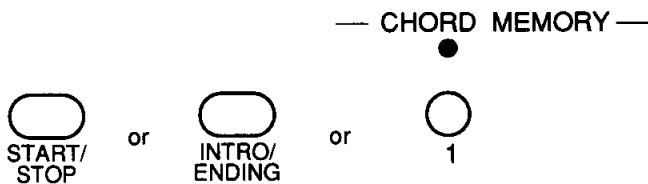

The DD-14 will stop recording automatically if you exceed the song capacity of 32 measures.

Recording Chords in Step Mode

When step recording, chord roots and types are specified by tapping on the percussion pads ⑤---or by tapping a pad while pressing the foot pedal---in much the same way as described for realtime recording. However, there are a couple of additional features that will want to use when recording in this mode. These features make use of the number buttons ②.

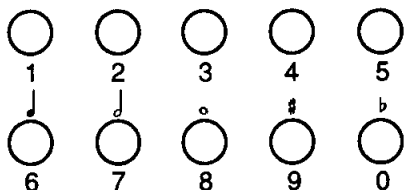

When specifying the root of chord, for example, you can hold down the "4" or "9" number button instead of pressing the foot pedal to raise the root a semitone. Also, you can lower the root a semitone by holding down the "5" or "0" number button when you play a pad.

After you specify each chord, you must also indicate how long the chord is to be played. To hold a chord for one beat (a quarter note), press the "1" or "6" number button. To hold it for two beats (a half note), press the "2" or "7" button. Finally, to hold it for four beats (a whole note), press the "3" or "8" button. For longer intervals, press these buttons in sequence: thus, for three beats, you could press the "7" button followed by the "6" button.

If you wish, you can press the FILL IN buttons ⑰ while recording to add fill-in patterns to your song. No matter what beat you press the FILL IN button on, the fill-in will advance the count to the top of the next measure. You can play a chord during a fill in by specifying the chord before you press the FILL IN button. If you do not specify a chord, the result will be a rest (i.e., percussion with no chords) during the fill-in. You cannot program a chord change in the middle of a fill-in.

Let's look at an example. To record the following measure, you would want to perform the steps described below.

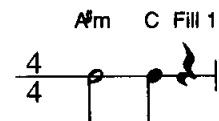

1. Play an A# minor chord.
Tap pad 6 while holding down the foot pedal or the "4" or "9" number button, to select the A# root. Then, tap pad 5 to select the minor chord type.
2. Play a half note.
Press the "2" or "7" number button to hold the A# minor chord for two beats.
3. Play a C major chord.
Tap pad 1 to the C root. Since the major chord type is automatically selected, there is no need to hit a second pad to specify the chord type.
4. Play a quarter note.
Press the "1" or "6" number button to hold the C major chord for one beat.
5. Play a fill in pattern.
Press the FILL IN 1 button to add a fill in pattern on the fourth beat of the measure. Since you won't specify a chord before selecting the fill in, the rhythm section will play it without any chord backing: hence, the rest.

5.3 Playback

To play back a recorded song, press the CHORD MEMORY PLAY button ⑱ corresponding to the desired song. If the song does not include an ending pattern, the DD-14 will play the song repeatedly until you stop it.

Play along on the percussion pads ⑤ if you like. You can also select a different accompaniment style, change the current percussion set, add fill-ins, or change the tempo during playback.

To stop the playback, press the START/STOP button ⑲ or the INTRO/ENDING button ⑳.

6. MIDI

MIDI stands for Musical Instrument Digital Interface, a worldwide standard that allows digital musical instruments and other equipment to communicate musical information and control one another. This standard makes it possible to create systems of MIDI instruments and equipment that offer far greater versatility than is possible with isolated instruments.

The DD-14 automatically transmits MIDI note and velocity information from its MIDI OUT terminal whenever you play one of the percussion pads, or the foot pedal. This information can be used to tell a receiving keyboard or tone

generator to play a certain note (specified by the MIDI note number) at a certain dynamic level (specified by the MIDI velocity value).

It is also capable of receiving the same information from an external keyboard or sequencer at the MIDI IN terminal. The DD-14's internal tone generator will play the corresponding note or instrument whenever such data is received. The MIDI note numbers corresponding to the DD-14's instruments (and melody instrument notes) are listed below.

NOTE NUMBER	INSTRUMENT	MIDI IN		MIDI OUT	
		Program	Channel	Program	Channel
D0	27	02	Bass Drum 3	x	10
E0	28	08	Snare Drum 5		
F0	29	16	E.Tom 2		
F#0	30	19	Closed Hi-Hat 2		
G0	31	20	Open Hi-Hat 2		
G#0	32	03	Bass Drum 4		
A0	33	06	Snare 3		
A#0	34	07	Snare 4 (Reverb)		
B0	35	00	Bass Drum 1		
C1	36	01	Bass Drum 2		
C#1	37	09	Rim Shot		
D1	38	04	Snare 1		
D#1	39	35	Hand Claps		
E1	40	05	Snare 2		
F1	41	10	Tom Lo		
F#1	42	17	Closed Hi-Hat 1		
G1	43	13	E.Tom 1 Lo		
G#1	44	17	Closed Hi-Hat 1		
A1	45	11	Tom Mid		
A#1	46	18	Open Hi-Hat 1		
B1	47	14	E.Tom 1 Mid		
C2	48	12	Tom Hi		
C#2	49	21	Crash Cymbal		
D2	50	15	E.Tom 1 Hi		
D#2	51	24	Ride Cymbal		
E2	52	--	--		
E#2	53	23	Ride Cup		
F2	54	38	Tambourine		
G2	55	22	Splash Cymbal		
G#2	56	36	Cowbell		
A2	57	21	Crash Cymbal		
A#2	58	--	--		
B2	59	24	Ride Cymbal		
C3	60	--	--		
C#3	61	--	--		
D3	62	27	Conga Mute		
D#3	63	26	Conga Hi		
E3	64	25	Conga Lo		
F3	65	29	Timbale Hi		
F#3	66	28	Timbale Lo		
G3	67	32	Agogo Hi		
G#3	68	31	Agogo Lo		
A3	69	37	Cabasa		
A#3	70	--	--		
B3	71	--	--		
C4	72	--	--		
C#4	73	41	Guiro (Short)		
D4	74	42	Guiro (Long)		
D#4	75	30	Claves		
E4	76	40	Cross Sticks		
F4	77	40	Cross Sticks		
F#4	78	34	Cuica Hi		
G4	79	33	Cuica Lo		
G#4	80	--	--		
A4	81	--	--		
A#4	82	39	Finger Snap		
B4	83	43	Bell Tree		
C5	84	44	"One"		
C#5	85	45	"Two"		
D5	86	46	"Three"		
D#5	87	47	"Four"		
E5	88	48	Dog		
F5	89	49	Cat		
F#5	90	50	Lion		
G5	91	51	Jungle		
G#5	92	52	Car Horn		
A5	93	53	Buzzer		
A#5	94	54	Dropping Coin		
B5	95	55	Water		
C6	96	56	Scratch		
C#6	97	57	"Wood"		
D6	98	58	Sound Effect 1		
D#6	99	59	Sound Effect 2		
E6	100	60	Sound Effect 3		
F6	101	61	Sound Effect 4		
F#6	102	62	Sound Effect 5		
G6	103	63	Sound Effect 6		
G#6	104	64	Applause		
C3 - C#4	60 - 73	65	Vibes	12	1
C3 - C#4	60 - 73	66	Marimba	13	2
C3 - C#4	60 - 73	67	Xylophone	14	3
C3 - C#4	60 - 73	68	Glockenspiel	10	4
C3 - C#4	60 - 73	69	Celesta	9	5
C3 - C#4	60 - 73	70	Steel Drum	115	6
C3 - C#4	60 - 73	71	Timpani	48	7
C3 - C#4	60 - 73	72	Bells	113	8
C3 - C#4	60 - 73	73	Orchestra Hit	56	9
C3 - C#4	60 - 73	74	Synth. Hit	64	11
				12	
				13	
				14	
				10	
				9	
				115	
				48	
				113	
				56	
				64	
					1 - 16

Playing a Keyboard or Tone Generator From the DD-14

When you connect the DD-14 MIDI OUT terminal to the MIDI IN terminal of a MIDI keyboard or tone generator, the keyboard or tone generator will respond to the notes played on the DD-14. Referring to the instrument and note list above, if SNARE DRUM 1 is assigned to PAD 1, then MIDI note number 38 will be transmitted whenever this pad is played, causing the receiving keyboard or tone generator to play the D1.

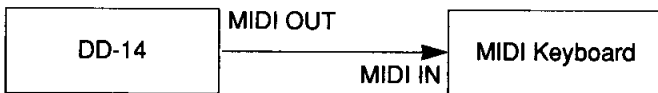

Playing the DD-14 From a Keyboard

When you connect the MIDI OUT terminal of a MIDI keyboard to the DD-14's MIDI IN terminal, then the DD-14 will play the instruments specified by any note information received from the keyboard. If the keyboard sends the D1, for example, the DD-14 will receive MIDI note number 38, causing the SNARE DRUM 1 instrument to sound.

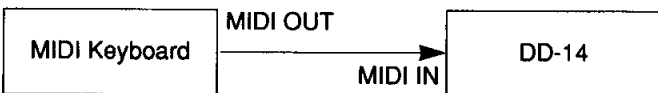

Sequence Recording With the DD-14

This same type of musical information transmission described in the above examples apply to MIDI sequence recording as well. This means that you can use a MIDI sequencer to record MIDI data received from the DD-14. When you retransmit the recorded data back to the DD-14, it will respond by playing the recorded performance in precise detail.

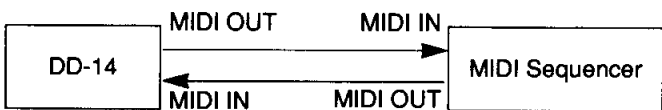

MIDI Transmit Channel Selection

The MIDI standard allows transmission and reception of MIDI data on 16 different channels. This large number of channels allows selective control of certain instruments or devices connected in series with others.

For example, a single MIDI sequence recorder could be used to "play" two different tone generators. One of the tone generators would be set to receive only on channel 1, while the other would receive only on channel 2. This arrangement would allow the sequence recorder to control two completely different parts played by the tone generators.

The DD-14 can be set to transmit notes on any of the sixteen channels. In addition, the ten melody percussion instruments are each assigned their own transmit channels. Generally speaking, the transmit channel for the currently selected DD-14 instrument should be set to match the receive channel setting of the receiving MIDI device.

To change the transmit channel, simultaneously press and hold both of the PAD/PEDAL ASSIGN buttons (2). The current MIDI transmit channel number will appear in the display (7). While still holding the PAD/PEDAL ASSIGN buttons, use the number buttons (2) to enter the new channel number. As always, enter two digits---not just one---to specify the channel number.

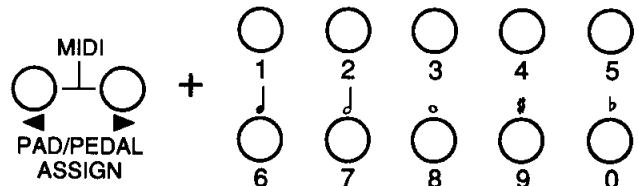

MIDI Synchronization

If you will be using the DD-14's Auto Accompaniment function in combination with a MIDI sequencer, you will want to synchronize the DD-14 to the sequencer so that they are both running on the same timing pulse.

You can do this by pressing the RECORD (10) switch while holding down both of the PAD/PEDAL ASSIGN buttons (2). When you do so, the message "on" will appear in the display to indicate that the DD-14's MIDI synchronization function has been turned on.



If you will not be synchronizing the DD-14 to an external device, you should be sure to turn this function off. Press the same buttons to display the "oF" message,



Model DD-14 MIDI Implementation Chart

Version : 1.0

Function		Transmitted	Recognized	Remarks
Basic Channel	Default Changed	1 - 11 1 - 16	1 - 16 1 - 16	
Mode	Default Messages Altered	3 X *****	3 X X	
Note Number :	True voice	27 - 104 *****	24 - 108 24 - 108	See page 15
Velocity	Note on Note off	O 9nH, v=1 - 127 X 9nH, v=0	O v=1 - 127 X	
After Touch	Key's Ch's	X X	X X	
Pitch Bender		X	X	
Control Change		X	X	
Program Change :	True #	O *****	O	
System Exclusive		O	O	
System :	Song Pos	X	X	
	Song Sel	X	X	
Common :	Tune	X	X	
System :	Clock	O	O	
Real Time :	Commands	O	O	
Aux :	Local On/OFF	X	X	
	All Notes OFF	X	X	
Mes- sages :	Active Sense	O	O	
	Reset	X	X	
Notes :				

Mode 1 : OMNI ON, POLY
Mode 3 : OMNI OFF, POLY

Mode 2 : OMNI ON, MONO
Mode 4 : OMNI OFF, MONO

O : Yes
X : No

Troubleshooting

In many cases, problems that appear to be malfunctions can be traced to simple causes. Please check the following list of symptoms, causes, and remedies before deciding that your DD-14 is broken.

Symptom	Cause	Remedy
A buzz or click occurs momentarily when the DD-14 is turned ON or OFF.	This is a result of the transient power surge that occurs when the POWER switch ⑧ is operated, and is normal.	-----
The sounds produced by some instruments (such as 65 VIBRAPHONE) are accompanied by a small amount of noise.	This noise is produced as a result of digital processing, and is normal.	-----
The display ⑦ is completely dark.	1. The batteries are running low. 2. The voltage may drop temporarily when the volume is turned up. This is normal.	1. If the problem is caused by low batteries, the batteries should be replaced immediately. 2. -----
No sound comes from the speakers.	1. The volume is turned down too low. 2. A plug is inserted into the HEADPHONES/AUX.OUT jack ⑳. This automatically shuts off the sound from the speakers.	1. Raise the VOLUME control ⑨ to an appropriate level. 2. Remove the plug from the HEADPHONES/AUX.OUT jack.
The percussion set selection has changed.	The percussion set selection changes automatically to match the style selection whenever the Minus One function is activated. This is normal.	-----
The wrong instrument plays when you strike a pad in one of the CUSTOM sets.	The desired instrument has not been properly assigned to the pad.	Assign the desired instrument to the pad. If you wish, you can restore the default assignments by turning the power on and off again.
The custom pad and pedal assignments have disappeared.	The DD-14 has not been played for about a week.	Redo the pad and pedal assignments.
Chord changes do not occur as expected during realtime recording.	The programmed chord change timing is improper.	Chord changes occur on individual beats of the selected rhythm style. The pads must therefore be played just prior to the beat on which the chord change is desired.

Specifications

Max. Simultaneous Notes

28

Instrument Voices

75 percussion (incl. 10 pitched) + 9 scraper

Percussion Sets

25 preset (incl. 10 pitched) + 5 user memory

Auto Rhythm/Auto Bass Chord Styles

100

Chord Memory Capacity

3 songs

Chord Memory Recording Modes

Realtime, Step

Auxiliary Functions

Super Session Player, Auto Roll, Tap Start, Break, Minus One, Auto Accompaniment demonstration (2 songs)

Percussion Controls

8 pads (touch sensitive) + 1 scraper

Touch Sensitivity

Two levels (high, low)

Panel Controls

POWER switch, VOLUME control, CHORD MEMORY RECORD button, CHORD MEMORY PLAY buttons, MINUS ONE button, SUPER SESSION PLAYER button, STYLE/PERCUSSION SET button, AUTO BASS CHORD button, START/STOP button, FILL IN buttons, INTRO/ENDING button, TAP START/BREAK button, PAD/PEDAL ASSIGN ◀ and ▶ buttons, SCRAPER ASSIGN button, Number buttons, TEMPO ◀ and ▶ buttons, AUTO ROLL button, DEMO button

Panel Displays

STYLE/PERCUSSION SET display, CHORD MEMORY PLAY indicators, MINUS ONE indicator, SUPER SESSION PLAYER indicator, STYLE/PERCUSSION SET indicator, AUTO BASS CHORD indicator, TAP START/BREAK indicator

Connectors

FOOT PEDAL, DC 10-12 V IN, HEADPHONES/AUX. OUT

MIDI Terminals

MIDI IN, MIDI OUT

Main Amplifier

(3 W (RMS), 8 ohms) x 2

Speaker

(10 cm, 8 ohms) x 2

Rated Voltage

DC 10--12 V

Power Source

Six "C" size, SUM-2, or R-14 batteries (or equivalent), or AC Power Adaptor (PA-3, PA-4, or PA-40)

Memory

Approx. 1 week

Dimensions (W x D x H)

608 x 281 x 105 mm (23-7/8 x 11 x 4-1/8 inches)

Weight

2.2 kg (4.9 lbs.) excluding batteries

Accessories

Percussion Sticks, Foot Pedal

Specifications and product appearance subject to change without notice.

FCC INFORMATION

IMPORTANT NOTICE : DO NOT MODIFY THIS UNIT!

This product, when installed as indicated in the instructions contained in this manual, meets FCC requirements. Modifications not expressly approved by Yamaha may void your authority, granted by the FCC, to use the product.

IMPORTANT :

When connecting this product to accessories and/ or another product use only high quality shielded cables. Cable/s supplied with this product MUST be used. Follow all installation instructions.

Failure to follow instructions could void your FCC authorization to use this product in the USA.

NOTE :

This product has been tested and found to comply with the requirements listed in FCC Regulations, Part 15 for Class "B" digital devices. Compliance with these requirements provides a reasonable level of assurance that your use of this product in a residential environment will not result in harmful interference with other electronic devices. This equipment generates/ uses radio frequencies and, if not installed and used according to the instructions found in the users manual, may cause interference harmful to the operation of other electronic devices. Compliance with FCC regulations does not guarantee that interference will not occur in all installations. If this product is found to be the source of interference, which can be determined by turning the unit "OFF" and "ON", please try to eliminate the problem by using one of the following measures:

Relocate either this product or the device that is being affected by the interference.

Utilize power outlets that are on different branch (circuit breaker or fuse) circuits or install AC line filter/ s.

In the case of radio or TV interference, relocate/ reorient the antenna. If the antenna lead-in is 300 ohm ribbon lead, change the lead-in to co-axial type cable.

If these corrective measures do not produce satisfactory results, please contact the local retailer authorized to distribute this type of product. If you can not locate the appropriate retailer, please contact Yamaha Corporation of America, Electronic Service Division, 6600 Orangethorpe Ave, Buena Park CA, 90620

The serial number of this product may be found on the bottom of the unit. You should note this serial number in the space provided below and retain this manual as a permanent record of your purchase to aid identification in the event of theft.

Model No. DD-14
Serial No.

Concerning the Warranty

This product was made for international distribution, and since the warranty for this type of product varies from marketing area to marketing area, please contact the selling agency for information concerning the applicable warranty and/ or service policies.

* This applies only to products distributed by YAMAHA Music Corporation of America.

For details of products, please contact your nearest Yamaha or the authorized distributor listed below.

Pour plus de détails sur les produits, veuillez-vous adresser à Yamaha ou au distributeur le plus proche de vous figurant dans la liste suivante.

Die Einzelheiten zu Produkten sind bei Ihrer unten aufgeführten Niederlassung und bei Yamaha Vertragshändlern in den jeweiligen Bestimmungsländern erhältlich.

Para detalles sobre productos, contacte su tienda Yamaha más cercana o el distribuidor autorizado que se lista debajo.

NORTH AMERICA

CANADA

Yamaha Canada Music Ltd.
135 Milner Avenue, Scarborough, Ontario, MIS 3R1,
Canada
Tel: 416-298-1311

U.S.A.

Yamaha Corporation of America
6600 Orangethorpe Ave., Buena Park, Calif. 90620,
U.S.A.
Tel: 714-522-9011

MIDDLE & SOUTH AMERICA

MEXICO

**Yamaha De Mexico S.A. De C.V.,
Departamento de ventas**
Javier Rojo Gomez No.1149, Col. Gpe Del Moral,
Deleg. Iztapalapa, 09300 Mexico, D.F.
Tel: 686-00-33

BRASIL

Yamaha Musical Do Brasil LTDA.
Ave. Reboucas 2636, São Paulo, Brasil
Tel: 55-11 853-1377

PANAMA

Yamaha De Panama S.A.
Edificio Interseco, Calle Elvira Mendez no.10, Piso 3,
Oficina #105, Ciudad de Panama, Panama
Tel: 507-69-5311

OTHER LATIN AMERICAN COUNTRIES AND CARIBBEAN COUNTRIES

Yamaha Music Latin America Corp.
6101 Blue Lagoon Drive, Miami, Florida 33126, U.S.A.
Tel: 305-261-4111

EUROPE

THE UNITED KINGDOM

Yamaha-Kemble Music(U.K.) Ltd.
Sherbourne Drive, Tilbrook, Milton Keynes, MK7 8BL
England
Tel: 0908-366700

IRELAND

Danfay Ltd.
61D, Sallynoggin Road, Dun Laoghaire, Co. Dublin
Tel: 01-2859177

GERMANY/SWITZERLAND

Yamaha Europa GmbH.
Siemensstraße 22-34, D-2084 Rellingen, F.R. of
Germany
Tel: 04101-3030

AUSTRIA/HUNGARY/SLOVENIA/ ROMANIA/BULGARIA

Yamaha Music Austria Ges mbH.
Schleiergasse 20, A-1100 Wien Austria
Tel: 0222-60203900

THE NETHERLANDS

**Yamaha Music Benelux B.V., Verkoop
Administratie**
Kanaalweg 18G, 3526 KL Utrecht, The Netherlands
Tel: 030-828411

BELGIUM/LUXEMBOURG

Yamaha Music Benelux B.V., Brussels-office
Keiberg Imperiastraat 8, 1930 Zaventem, Belgium
Tel: 02-7258220

FRANCE

**Yamaha Musique France, Division
Instruments Electroniques et de Scène**
BP 70-77312 Marne-la-Valée Cedex 2, France
Tel: 01-64-61-4000

ITALY

**Yamaha Musica Italia S.P.A., Home Keyboard
Division**
Viale Italia 88, 20020 Lainate(Milano), Italy
Tel: 02-935-771

SPAIN

Yamaha-Hazen Electronica Musical, S.A.
Jorge Juan 30, 28001, Madrid, Spain
Tel: 91-577-7270

PORTUGAL

Valentim de Carvalho CI SA
Estrada de Porto Salvo, Paço de Arcos 2780 Oeiras,
Portugal
Tel: 01-443-3398/4030/1823

GREECE

Philippe Nakas S.A.
Navarinou Street 13, P.Code 10680, Athens, Greece
Tel: 01-364-7111

SWEDEN

Yamaha Scandinavia AB
J. A. Wettergrens gata 1, Box 30053, 400 43 Göteborg,
Sweden
Tel: 031-496090

DENMARK

YS Copenhagen Liaison Office
Finsensvej 86, DK-2000 Frederiksberg, Denmark
Tel: 31-87 30 88

FINLAND

Fazer Music Inc.
Aleksanterinkatu 11, SF 00100 Helsinki, Finland
Tel: 0435 011

NORWAY

Narud Yamaha AS
Østerdalen 29, 1345 Østerås
Tel: 02-24 47 90

ICELAND

Páll H. Pálsson
P.O. Box 85, 121 Reykjavik, Iceland
Tel: 01-19440

OTHER EUROPEAN COUNTRIES

Yamaha Europa GmbH.
Siemensstraße 22-34, D-2084 Rellingen, F.R. of
Germany
Tel: 04101-3030

AFRICA

**Yamaha Corporation, International
Marketing Division**
Nakazawa-cho 10-1, Hamamatsu, Japan 430
Tel: 053-460-2311

MIDDLE EAST

TURKEY/CYPRUS

Yamaha Musique France, Division Export
BP 70-77312 Marne-la-Valée Cedex 2, France
Tel: 01-64-61-4000

OTHER COUNTRIES

**Yamaha Corporation, International
Marketing Division**
Nakazawa-cho 10-1, Hamamatsu, Japan 430
Tel: 053-460-2311

ASIA

HONG KONG

Tom Lee Music Co., Ltd.
11/F., Silvercord Tower 1, 30 Canton Road, Tsimshatsui,
Kowloon, Hong Kong
Tel: 730-1098

INDONESIA

**PT. Yamaha Music Indonesia (Distributor) PT.
Nusantik**
Gedung Yamaha Music Center, Jalan Jend. Gatot
Subroto Kav. 4, Jakarta 12930, Indonesia
Tel: 21-520-2577

KOREA

Cosmos Corporation
#131-31, Neung-Dong, Sungdong-Ku, Seoul, Korea
Tel: 02-466-0021~5

MALAYSIA

Yamaha Music Malaysia Sdn., Bhd.
16-28, Jalan SS 2/72, Petaling Jaya, Selangor, Malaysia
Tel: 3-717-8977

PHILIPPINES

Yupangco Music Corporation
339 Gil J. Puyat Avenue, P.O. Box 885 MCPO, Makati,
Metro Manila, Philippines
Tel: 819-7551

SINGAPORE

Yamaha Music Asia Pte., Ltd.
Bik 17A Toa Payoh #01-190 Lorong 7, Singapore 1231
Tel: 354-0133

TAIWAN

Kung Hsue She Trading Co., Ltd.
No. 322, Section 1, FuHsing S. Road, Taipei 106,
Taiwan. R.O.C.
Tel: 02-709-1266

THAILAND

Siam Music Yamaha Co., Ltd.
933/1-7 Rama I Road, Patumwan, Bangkok, Thailand
Tel: 2-215-0030

THE PEOPLE'S REPUBLIC OF CHINA AND OTHER ASIAN COUNTRIES

**Yamaha Corporation,
International Marketing Division**
Nakazawa-cho 10-1, Hamamatsu, Japan 430
Tel: 053-460-2311

OCEANIA

AUSTRALIA

Yamaha Music Australia Pty. Ltd.
17-33 Market Street, South Melbourne, Vic. 3205,
Australia
Tel: 3-699-2388

NEW ZEALAND

Music Houses of N.Z. Ltd.
146/148 Captain Springs Road, Te Papapa, Auckland
New Zealand
Tel: 9-634-0099

COUNTRIES AND TRUST TERRITORIES IN PACIFIC OCEAN

**Yamaha Corporation,
International Marketing Division**
Nakazawa-cho 10-1, Hamamatsu, Japan 430
Tel: 053-460-2311

DD-14

Instruments

Type	No.	Instrument
Bass Drums	00	Bass Drum 1
	01	Bass Drum 2
	02	Bass Drum 3
	03	Bass Drum 4
Snare Drums	04	Snare 1
	05	Snare 2
	06	Snare 3
	07	Snare 4
	08	Snare 5
	09	Rim Shot
Toms	10	Tom Lo
	11	Tom Mid.
	12	Tom Hi
	13	E.Tom 1 Lo
	14	E.Tom 1 Mid.
	15	E.Tom 1 Hi
Hi-Hats	16	E.Tom 2
	17	Closed Hi-Hat 1
	18	Open Hi-Hat 1
	19	Closed Hi-Hat 2
Cymbals	20	Open Hi-Hat 2
	21	Crash Cymbal
	22	Splash Cymbal
	23	Ride Cup
Percussion	24	Ride Cymbal
	25	Conga Lo
	26	Conga Hi
	27	Conga Mute
	28	Timbale Lo
	29	Timbale Hi
	30	Claves
	31	Agogo Lo
	32	Agogo Hi
	33	Cuica Lo
	34	Cuica Hi
	35	Hand Claps
	36	Cowbell
	37	Cabasa
	38	Tambourine
	39	Finger Snap

Type	No.	Instrument
Percussion	40	Cross Sticks
	41	Guiro (Short)
	42	Guiro (Long)
	43	Bell Tree
	44	"One"
	45	"Two"
Sound Effects	46	"Three"
	47	"Four"
	48	Dog
	49	Cat
	50	Lion
	51	Jungle
	52	Car Horn
	53	Buzzer
	54	Dropping Coin
	55	Water
	56	Scratch
	57	"Woo"
	58	Sound Effect 1
	59	Sound Effect 2
	60	Sound Effect 3
	61	Sound Effect 4
	62	Sound Effect 5
	63	Sound Effect 6
	64	Applause
Melody Percussion * 1	65	Vibes
	66	Marimba
	67	Xylophone
	68	Glockenspiel
	69	Celesta
	70	Steel Drum
	71	Timpani
	72	Bells
	73	Orchestra Hit
	74	Synth. Hit
Rhythm Controls	In	Intro
	F1	Fill In 1
	F2	Fill In 2
	En	Ending

* 1: Each pad plays the melody percussion instruments (65 through 74) at a different pitch: Pad 1 plays them the note C, Pad 2 plays a D, and so on. Also, these instruments may not be assigned to the foot pedal.

YAMAHA