

MusicCAST 

Digital Audio Terminal

MCX-A10

OWNER'S MANUAL

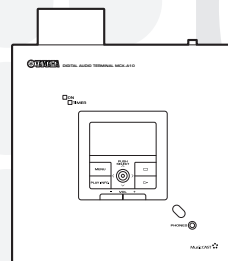
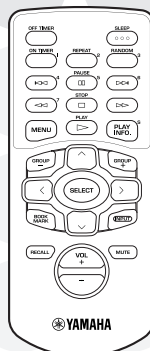

IMPORTANT SAFETY INSTRUCTIONS

- 1 Read these instructions.
- 2 Keep these instructions.
- 3 Heed all warnings.
- 4 Follow all instructions.
- 5 Do not use this apparatus near water.
- 6 Clean only with dry cloth.
- 7 Do not block any ventilation openings. Install in accordance with the manufacturer's instructions.
- 8 Do not install near any heat sources such as radiators, heat registers, stoves, or other apparatus (including amplifiers) that produce heat.
- 9 Do not defeat the safety purpose of the polarized or grounding-type plug. A polarized plug has two blades with one wider than the other. A grounding type plug has two blades and a third grounding prong. The wide blade or the third prong are provided for your safety. If the provided plug does not fit into your outlet, consult an electrician for replacement of the obsolete outlet.
- 10 Protect the power cord from being walked on or pinched particularly at plugs, convenience receptacles, and the point where they exit from the apparatus.
- 11 Only use attachments/accessories specified by the manufacturer.
- 12 Use only with the cart, stand, tripod, bracket, or table specified by the manufacturer, or sold with the apparatus. When a cart is used, use caution when moving the cart/apparatus combination to avoid injury from tip-over.
- 13 Unplug this apparatus during lightning storms or when unused for long periods of time.
- 14 Refer all servicing to qualified service personnel. Servicing is required when the apparatus has been damaged in any way, such as power-supply cord or plug is damaged, liquid has been spilled or objects have fallen into the apparatus, the apparatus has been exposed to rain or moisture, does not operate normally, or has been dropped.



FCC INFORMATION (for US customers only)

1. **IMPORTANT NOTICE : DO NOT MODIFY THIS UNIT!** This product, when installed as indicated in the instructions contained in this manual, meets FCC requirements. Modifications not expressly approved by Yamaha may void your authority, granted by the FCC, to use the product.
2. **IMPORTANT :** When connecting this product to accessories and/or another product use only high quality shielded cables. Cable/s supplied with this product **MUST** be used. Follow all installation instructions. Failure to follow instructions could void your FCC authorization to use this product in the USA.
3. **NOTE :** This product has been tested and found to comply with the requirements listed in FCC Regulations, Part 15 for Class "B" digital devices. Compliance with these requirements provides a reasonable level of assurance that your use of this product in a residential environment will not result in harmful interference with other electronic devices.
This equipment generates/uses radio frequencies and, if not installed and used according to the instructions found in the users manual, may cause interference harmful to the operation of other electronic devices.

Compliance with FCC regulations does not guarantee that interference will not occur in all installations. If this product is found to be the source of interference, which can be determined by turning the unit "OFF" and "ON", please try to eliminate the problem by using one of the following measures:

Relocate either this product or the device that is being affected by the interference.

Utilize power outlets that are on different branch (circuit breaker or fuse) circuits or install AC line filter/s.

In the case of radio or TV interference, relocate/reorient the antenna. If the antenna lead-in is 300 ohm ribbon lead, change the lead-in to coaxial type cable.

If these corrective measures do not produce satisfactory results, please contact the local retailer authorized to distribute this type of product. If you can not locate the appropriate retailer, please contact Yamaha Electronics Corp., U.S.A. 6660 Orangethorpe Ave, Buena Park, CA 90620.

The above statements apply **ONLY** to those products distributed by Yamaha Corporation of America or its subsidiaries.

Caution: read this before operating this unit

- To assure the finest performance, please read this manual carefully. Keep it in a safe place for future reference.
- Install this unit in a well ventilated, cool, dry, clean place – away from direct sunlight, heat sources, vibration, dust, moisture, and/or cold. Avoid ventilation space of at least 30 cm on the top, 20 cm on the left and right.
- Locate this unit away from other electrical appliances, motors, or transformers to avoid humming sounds.
- Do not expose this unit to sudden temperature changes from cold to hot, and do not locate this unit in an environment with high humidity (i.e. a room with a humidifier) to prevent condensation inside this unit, which may cause an electrical shock, fire, damage to this unit, and/or personal injury.
- Avoid installing this unit where foreign objects may fall onto this unit and/or this unit may be exposed to liquid dripping or splashing. On the top of this unit, do NOT place:
 - Other components, as they may cause damage and/or discoloration on the surface of this unit.
 - Burning objects (i.e. candles), as they may cause fire, damage to this unit, and/or personal injury.
 - Containers with liquid in them, as they may fall and liquid may cause electrical shock to the user and/or damage to this unit.
- Do not cover the rear panel of this unit with a newspaper, tablecloth, curtain, etc. in order not to obstruct heat radiation. If the temperature inside this unit rises, it may cause fire, damage to this unit, and/or personal injury.
- Do not plug this unit in to a wall outlet until all connections are complete.
- Do not operate this unit upside-down. It may overheat, possibly causing damage.
- Do not use force on switches, knobs and/or cords.
- When disconnecting the power cord from the wall outlet, grasp the plug; do not pull the cord.
- Do not clean this unit with chemical solvents; this might damage the finish. Use a clean, dry cloth.
- Only the voltage specified on this unit must be used. Using this unit with a higher voltage than specified is dangerous and may cause fire, damage to this unit, and/or personal injury. YAMAHA will not be held responsible for any damage resulting from use of this unit with a voltage other than specified.
- To prevent damage by lightning, disconnect the power cord from the wall outlet during an electrical storm.
- Do not attempt to modify or fix this unit. Contact qualified YAMAHA service personnel when any service is needed. The cabinet should never be opened for any reasons.
- When not planning to use this unit for long periods of time (i.e. vacation), disconnect the AC power plug from the wall outlet.
- Be sure to read the “TROUBLESHOOTING” section on common operating errors before concluding that this unit is faulty.
- Before moving this unit, press **STANDBY/ON** to place the unit in standby mode, and disconnect the AC power plug from the wall outlet.
- Be sure to use the AC adaptor (LSE0107A1240) supplied with this unit. Otherwise, you might cause a fire or damage to this unit.
- This unit is designed for home use only. Never use this unit in a car, etc., otherwise it may cause a malfunction of this unit.

This unit is not disconnected from the AC power source as long as it is connected to the wall outlet, even if this unit itself is turned off. This state is called the standby mode. In this state, this unit is designed to consume a very small quantity of power.

WARNING

TO REDUCE THE RISK OF FIRE OR ELECTRIC SHOCK, DO NOT EXPOSE THIS UNIT TO RAIN OR MOISTURE.

IMPORTANT!

Please record the serial number of this unit in the space below.

Model:
Serial No.:

The serial number is located on the rear of the unit. Retain this Owner's Manual in a safe place for future reference.

SPECIAL INSTRUCTIONS FOR U.K. MODEL

IMPORTANT

The wires in this mains lead are colored in accordance with the following code:

GREEN-and-YELLOW:Earth
BLUE:Neutral
BROWN:Live

As the colors of the wires in the mains lead of this apparatus may not correspond with the colored markings identifying the terminals in your plug proceed as follows: The wire which is colored GREEN-and-YELLOW must be connected to the terminal in the plug which is marked by the letter E or by the safety earth symbol \perp or colored GREEN or GREEN-and-YELLOW. The wire which is colored BLUE must be connected to the terminal which is marked with the letter N or colored BLACK. The wire which is colored BROWN must be connected to the terminal which is marked with the letter L or colored RED.

For U.K. customers

If the socket outlets in the home are not suitable for the plug supplied with this appliance, it should be cut off and an appropriate 3 pin plug fitted. For details, refer to the instructions described above.

Note: The plug severed from the mains lead must be destroyed, as a plug with a bared flexible cord is hazardous if engaged in a live socket outlet.

For Canadian Customers

To prevent electric shock, match wide blade of plug to wide slot and fully insert.

This Class B digital apparatus complies with Canadian ICES-003.

For US customers

This equipment complies with FCC radiation exposure limits set forth for uncontrolled equipment. This equipment should be installed and operated with a minimum distance of at least 20cm between the radiator and the persons body (excluding extremities: hands, wrists, feet, and legs) and must not be co-located or operated with any other antenna or transmitter.

For Canadian customers

Operation is subject to the following two conditions: (1) This device may not cause interference, and (2) this device must accept any interference received, including interference that may cause undesired operation of the device.

The installer of this radio equipment must ensure that the antenna is located or pointed such that it does not emit RF field in excess of Health Canada limits for the general population; consult Safety Code 6, obtainable from Health Canada's website www.hc-sc.gc.ca/rpb

For U.K. and European customers

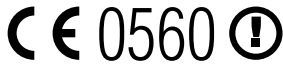

We, the manufacturer YAMAHA hereby declare that the MCX-A10 is in compliance with the essential requirements and other relevant provisions of Directive 1999/5/EC.

Vi, tillverkaren YAMAHA, betygar härmed att MCX-A10 är i överensstämmelse med de erforderliga krav och andra tillämpliga bestämmelser som anges i direktivet 1999/5/EC.

Noi, il fabbricante YAMAHA, con questo dichiariamo che MCX-A10 si trova in osservanza dei requisiti essenziali e delle altre normative pertinenti della direttiva 1999/5/EC.

Nosotros, el fabricante YAMAHA, declaramos por el presente testamento que el MCX-A10 cumple con los requisitos esenciales y otras provisiones pertinentes de la Directiva 1999/5/EC.

YAMAHA verklaart hierbij dat de MCX-A10 voldoet aan de essentiële vereisten en andere relevante voorzieningen van Richtlijn 1999/5/EC.

Allen voor klanten in Nederland

Bij dit product zijn batterijen geleverd. Wanneer deze leeg zijn, moet u ze niet weggooien maar inleveren als KCA.

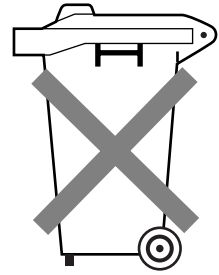

CAUTION

Danger of explosion if battery is incorrectly replaced. Replace only with the same or equivalent type.

ADVARSEL!

Lithiumbatteri-Eksplosionsfare ved fejlagtig håndtering. Udsiftning må kun ske med batteri af samme fabrikat og type. Levér det brugte batteri tilbage til leverandøren.

WARNING

Explosionsfara ved felaktigt batteribyte. Använd samma batterityp eller en ekvivalent typ som rekommenderas av apparattillverkaren. Kassera använt batteri enligt fabrikantens instruktion.

VAROITUS

Paristo voi räjähtää, jos se on virheellisesti asennettu. Vaihda paristo ainoastaan laitevalmistajan suosittelemaan tyyppiin. Hävitä käytetty paristo valmistajan ohjeiden mukaisesti.



Fraunhofer Institut Integrierte Schaltungen

MPEG Layer-3 audio coding technology licensed from Fraunhofer IIS and Thomson

This product contains AVE-TCP from ACCESS CO.LTD. Copyright © 1996-2002 ACCESS CO.,LTD

Contents

About your MusicCAST client

The MusicCAST client	8
Features	8
Supplied accessories	9
Controls and functions	10
Front panel	10
Side panel	11
Remote control	12
Modes of operation of the MusicCAST client	14
To turn the MusicCAST client on from STANDBY mode	14
Using the Graphical User Interface of the MusicCAST client	15
MusicCAST client Top Menu	15
The lock icon	15
The MusicCAST client controller	15
Play Info screen	16

Setting up the MusicCAST client

Before setup	17
Attaching the stand	17
Mounting the MusicCAST client on a wall	17
Removing the side-panel cover	18
Remote control	18
Loading the battery for the remote control	18
Battery replacement	18
Notes on the lithium battery	18
Remote control operation range	19
Connecting the AC adaptor	19
Checking MusicCAST client connections	20
The MusicCAST network	21
Network addresses	22
Assigning IP addresses	22
Wireless network connections	23
When and why should I use a wireless connection?	23
Wired network connections	24
When should I use a wired connection?	24
What is a hub, and why do I need one?	24
Connecting to the network	25
Configuring your MusicCAST client	25

Using the Auto Configuration function	26
Configuring your MusicCAST client manually	28
Accessing the Manual Setup screen ...	29
Setting the Network Mode	29
Setting the ESS ID	30
Setting your MusicCAST client to act as a DHCP client	31
Setting the MusicCAST server Server ID	32
Setting the MusicCAST client IP Address	32
Setting the Subnet Mask Address	33
Setting the WEP key for your MusicCAST client	33
Connection check	34

Playing back songs

Music playback on the MusicCAST client ...	35
Playback groups	35
During playback	36
To play a song from an artist	37
To play a song from an album	38
To play a song from a genre	39
To select a song from the complete list of songs	40
Using Playlists	41
Accessing playlists with your MusicCAST client	41
Song Statistics	42
To play a song in the list of bookmarks ...	43
Advanced playback options	45
Random Playback	45
To use the Random Playback function	45
To alter the limits of Random Playback	45
Repeat Playback	46
To use the Repeat Playback function ..	46
Changing the time display on the Play Info screen	47
To alter the time display	47
Listening to an external source connected to the MusicCAST server	48
To return to playback from the MusicCAST server library	49
Listening to a radio station with your MusicCAST client	49

Selecting a radio station	50	Resetting the MusicCAST client to default settings	66
Listening to an external sound source	51	Resetting your MusicCAST client	66
To return to playback from the MusicCAST server library	51	Displaying Network Status Information on the MusicCAST client	67
Using the Bookmark function	52	Accessing the Network Status screen	67
Adding a song to the list of bookmarks	52		
Adding a song using the Play Info screen	52		
Adding a song using the menu	52		
Removing a song from the bookmark list	53		
Removing a song using the Menu	53		
Copying the bookmark list to a playlist	54		
Copying the bookmark list	54		
Erasing the bookmark list	55		
Erasing the bookmark list	55		

Other functions

MusicCAST settings	56
Default system settings	56
Using the OFF Timer function	57
Using the menu to set the OFF Timer function	57
Using OFF TIMER on the remote control to set the OFF Timer	57
Using the ON Timer function	58
Setting the timer	58
Using the ON TIMER key to activate the ON Timer	59
Using the Auto Play function	59
Using the Auto Level Control function	60
Turning Auto Level Control on or off	60
Using the tone controls	61
Altering the tone settings	61
Using the contrast controls	62
Altering the contrast settings	62
Using the Sleep function	63
Switching the unit to sleep mode	63
Turning the MusicCAST client on again	63
System settings	64
Displaying System Information on the MusicCAST client	64
Accessing the System Information screen	64
Updating the MusicCAST client firmware	65

Appendix

Troubleshooting	69
Terms used in this manual	72
Specifications	74
Index	75

The MusicCAST client

The MusicCAST client is designed to work in conjunction with the Yamaha MusicCAST server to allow you to store and listen to your entire music collection. With multiple clients, you and others can simultaneously access and listen to your music collection from up to seven different locations.

Features

- ◆ Wireless networking with the MusicCAST server
- ◆ Instant access to all music data stored on the MusicCAST server
- ◆ Simultaneous playback from multiple locations (for multiple clients)
- ◆ 128 x 64 dot LCD display and remote control for easy operation
- ◆ Internal Yamaha digital amplifier
- ◆ 2 x 17 W/4 Ω outputs
- ◆ Slim Desktop/Wall mountable design

This owner's manual refers to the MCX-1000 DIGITAL AUDIO SERVER as the MusicCAST server and the MCX-A10 DIGITAL AUDIO TERMINAL as the MusicCAST client.

We Want You Listening For A Lifetime

YAMAHA and the Electronic Industries Association's Consumer Electronics Group want you to get the most out of your equipment by playing it at a safe level. One that lets the sound come through loud and clear without annoying blaring or distortion – and, most importantly, without affecting your sensitive hearing. Since hearing damage from loud sounds is often undetectable until it is too late, YAMAHA and the Electronic Industries Association's Consumer Electronics Group recommend you to avoid prolonged exposure from excessive volume levels.



Supplied accessories

After unpacking, check that the following parts are included.

Remote control

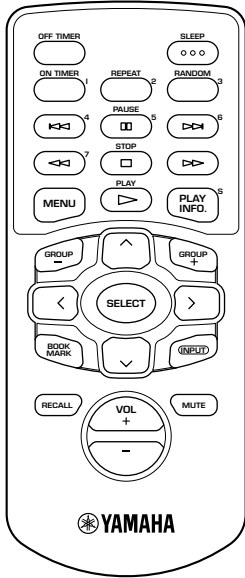

Lithium battery



Audio pin cable

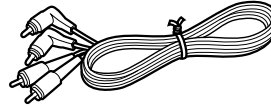

Subwoofer cable



Video pin cable



Stand

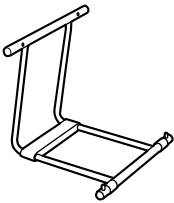

Screw x 2



AC adaptor (LSE0107A1240)

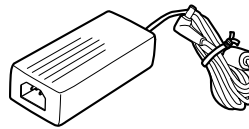

AC power cable

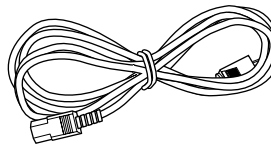

Front panel

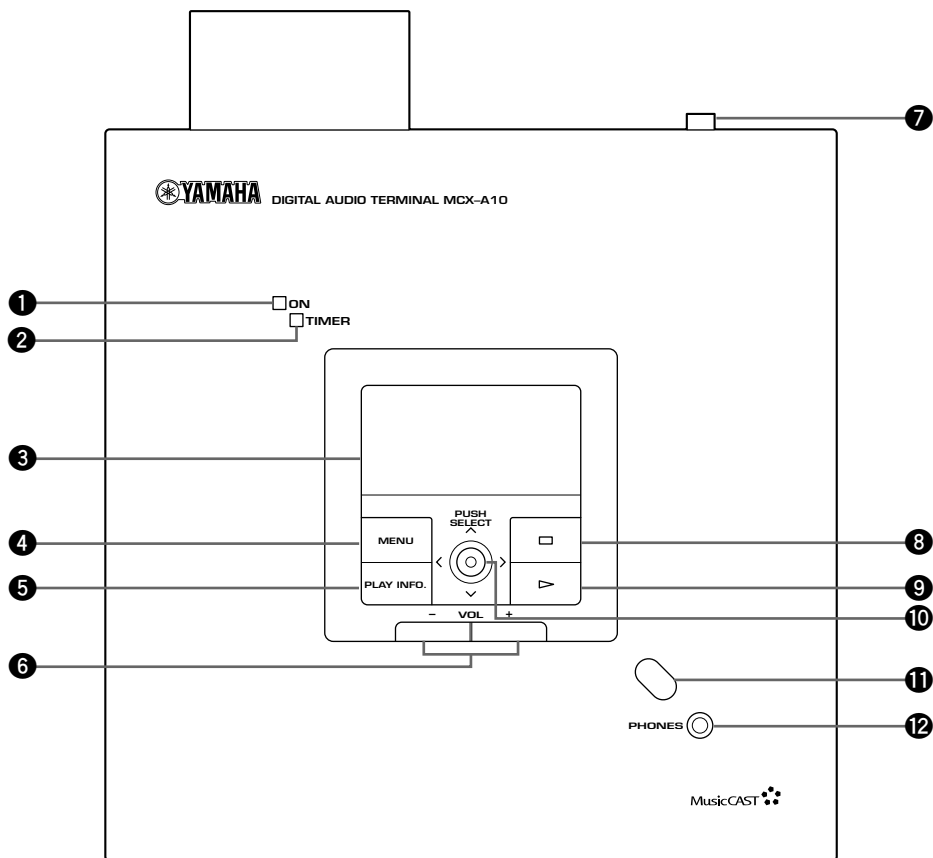

1 POWER indicator

Lights when the MusicCAST client is active.

2 TIMER indicator

Lights when the timer function is activated (see pages 57 – 59).

3 Front panel display

Displays information on the settings and songs available in your MusicCAST network.

4 MENU

Returns the on-screen display to the menu page.

5 PLAY INFO.

Displays information on the song you are currently listening to on the front panel display.

6 VOL +/-

Adjust the volume of the MusicCAST client output.

7 STANDBY/ON

Switches the MusicCAST client between ON and STANDBY modes.

8 □

Halts playback from the MusicCAST client.

9 ▷

Begins playback of the selected track.

10 Controller

Moves the on-screen cursor within the Graphical User Interface, and enters, deletes, or selects the selection highlighted on the front panel display.

11 Remote control signal receiver

Receives signals from the MusicCAST client remote control.

12 PHONES jack

Insert your headphones plug here to listen to the MusicCAST client through headphones. Output from the S.WOOFER jack and SPEAKER OUT terminals stops.

Side panel

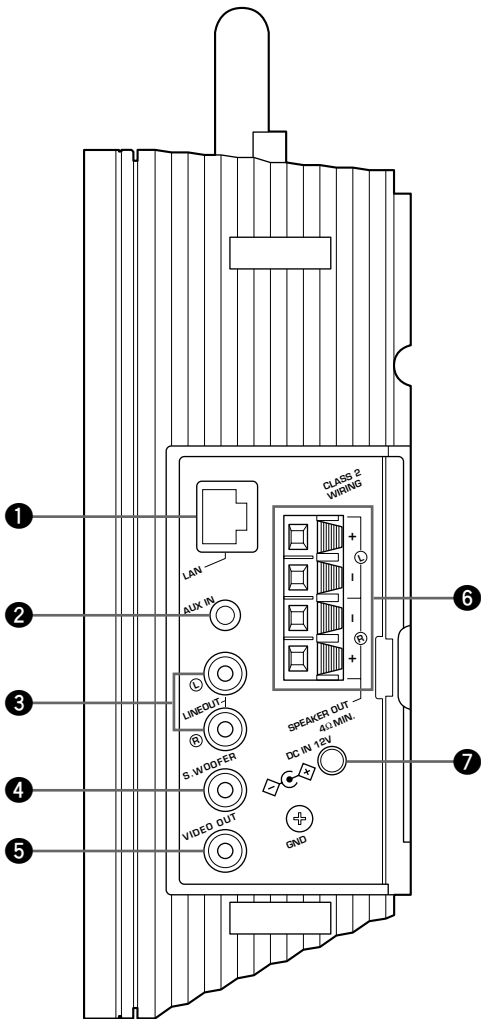

❶ LAN port

Insert a LAN cable here to connect to a wired network.

❷ AUX IN jack

Connect an external sound source here.

❸ LINEOUT L/R jacks

Use these jacks to connect the MusicCAST client to an input on an external component.

❹ S. WOOFER jack

Use this jack to connect the MusicCAST client to a subwoofer to achieve a more powerful, better defined bass sound.

❺ VIDEO OUT jack

Use this jack to connect the MusicCAST client to an external view device, such as a monitor or television. You can view the front panel display on this device.

❻ SPEAKER OUT terminals

Connect speaker cables to these terminals.

❼ AC adaptor input

Connect the AC adaptor to this input.

Remote control

This section explains the function of each button on the remote control.

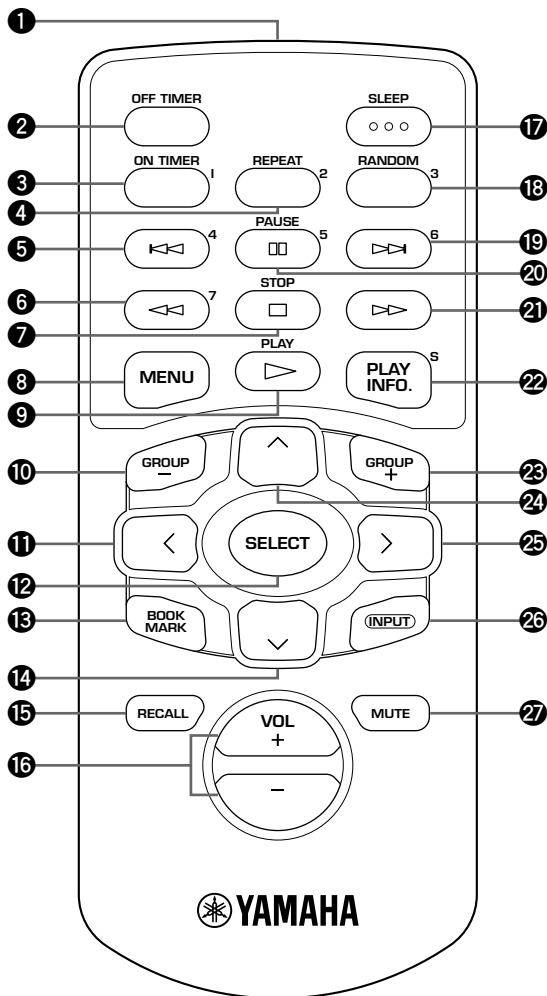

❶ Infrared emitter

Emits infrared control signals for the MusicCAST client to receive. Aim the emitter at the MusicCAST client when you want to operate it.

❷ OFF TIMER

Activates the off timer function (see page 57) and cycles through the available timer settings.

❸ ON TIMER

Switches the ON TIMER function (see pages 58, 59) on and off.

❹ REPEAT

Places the unit in repeat playback mode (see pages 46, 47).

❺ <<<

Accesses the previous track in the group you are listening to.

❻ <<

Searches back through the current song.

❼ □ (STOP)

Halts playback from the MusicCAST client.

❽ MENU

Returns the on-screen display to the menu page.

❾ ▷ (PLAY)

Begins playback of the selected track.

❿ GROUP -

Accesses the previous playback group.

⓫ <

Moves the on-screen cursor to the left, and accesses the previous menu page.

⓬ SELECT

Enters, deletes, plays, or selects the selection highlighted on the front panel display.

13 BOOKMARK

Attaches or removes a bookmark from a song (see pages 52 – 55).

14 ∨

Moves the on-screen cursor down.

15 RECALL

This button and the corresponding Recall Play menu in the MusicCAST client are reserved for future functionality.

16 VOL +/-

Adjust the volume of the MusicCAST client output.

17 SLEEP

Switches the MusicCAST client between sleep and on modes.

18 RANDOM

Places the unit in random playback mode (see pages 45, 46).

19 ▷▷

Accesses the next song in the group you are listening to.

20 || (PAUSE)

Pauses playback of the track you are currently listening to.

21 ▷▷

Searches forwards through the current song.

22 PLAY INFO.

Displays information on the song you are currently listening to on the front panel display.

23 GROUP +

Accesses the next playback group.

24 ∧

Moves the on-screen cursor up.

25 >

Enters into menu items highlighted on the front panel display, and moves the on-screen cursor to the right.

26 INPUT

Switches the input to the amplifier in the MusicCAST client between the signal from the MusicCAST server and signals received from the AUX IN jack.

27 MUTE

Mutes the output from the unit.

Modes of operation of the MusicCAST client

The MusicCAST client has three modes of operation.

- **STANDBY:** The MusicCAST client is connected to an AC outlet with STANDBY/ON on its top surface in the STANDBY position (fully up).
- **SLEEP:** The MusicCAST client is connected to an AC outlet with STANDBY/ON on its top surface in the ON position (fully down), the POWER indicator on its front panel lit, and the time displaying on its front panel display.
- **ON:** The MusicCAST client is connected to an AC outlet with STANDBY/ON on its top surface in the ON position (fully down), the POWER indicator on its front panel lit, and information other than the time displaying on its front panel display.

■ To turn the MusicCAST client on from STANDBY mode

1. Press STANDBY/ON.

The MusicCAST client turns on, displaying its startup screen, then displays the Top Menu screen.



2. The MusicCAST client attempts to connect to the MusicCAST server, displaying the following screen:

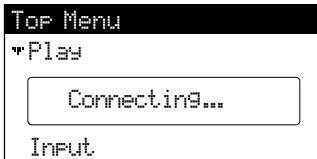

3. If it is able to make a connection, the MusicCAST client returns to the Top Menu screen, displaying the network connection icon in the top right corner of the screen.

If it is not able to make a connecting, the MusicCAST client continues displaying the "Connecting..." message. Press any of the controls on the MusicCAST client to erase this message, and check the MusicCAST client network connection settings.

Note

- If you do not use the MusicCAST client for 30 minutes, it automatically places itself in sleep mode. Press SELECT or SLEEP to reactivate it.

Using the Graphical User Interface of the MusicCAST client

The MusicCAST client offers a wide variety of functions and parameters for your use. You can access all of these through the Graphical User Interface (GUI) viewable from the front panel display on the MusicCAST client itself. The interface, as laid out below, is simple and easy to understand.

■ MusicCAST client Top Menu

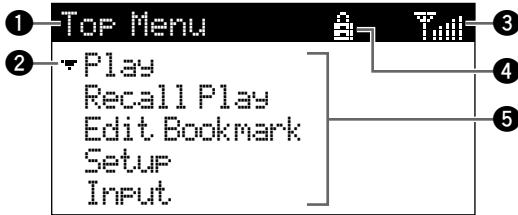

- ❶ Menu name
- ❷ Cursor
- ❸ Connection icon
- ❹ Lock icon
- ❺ Menu

This is a typical screen from the GUI of the MusicCAST client. All of the features indicated here are displayed on almost all of the screens you encounter when using the MusicCAST client. Use the cursor keys on the remote to move the cursor to the desired position, and SELECT to perform an action.

■ The lock icon

The MusicCAST server can lock MusicCAST clients so that you can only control the volume and mute functions, or stop playback. When locked, the MusicCAST client displays the lock icon in the dark bar at the top of the on-screen display. You can reset the lock by unlocking the MusicCAST client from the MusicCAST server. Refer to the MCX-1000 owner's manual for more information on locking clients.

■ The MusicCAST client controller

Moving the controller in the directions indicated on the front panel of the MusicCAST client performs the same actions as pressing the equivalent cursor key on the remote control. For example, pushing the MusicCAST client controller upwards produces the same result as pressing \wedge on the remote control. Pushing the controller directly into the front panel has the same effect as pressing SELECT on the remote control.

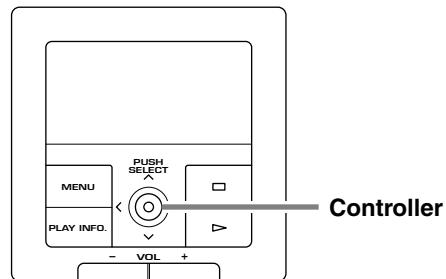

This manual explains how to use the various functions of the MusicCAST client using the remote control only. While many functions are accessible from the main panel of the MusicCAST client, some functions are only accessible from the remote control.

■ Play Info screen

Press PLAY INFO to display this screen on the on-screen display of the MusicCAST client.

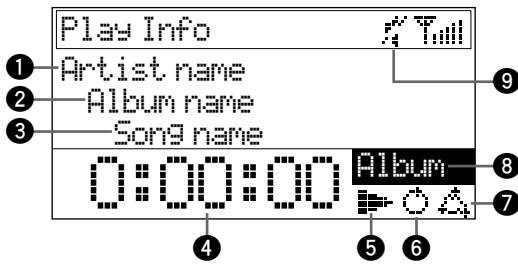

1 Artist name

2 Album name

3 Song name

4 Time counter

5 Current action mode icon

Indicates the current action being taken by the MusicCAST.

□: Playback is stopped

▷: Playing a song

⏸: Playback is paused

6 Repeat icon

Indicates whether or not the MusicCAST client is in repeat play mode.

7 Random play icon

8 Group skip target

Indicates the group within which the group skip function is currently operating.

9 Mute icon

The Play Info screen displays information on the song the MusicCAST is currently playing, or the last song played if it is not currently playing a song.

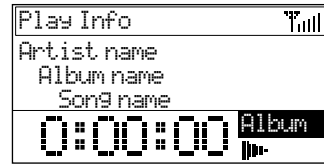

Note

- MusicCAST clients can use the VIDEO OUT jack on the MusicCAST client to display the on-screen display on a TV/monitor.

Attaching the stand

1. Place the MusicCAST client so that its front panel display faces down, taking care not to scratch the front panel in the process.

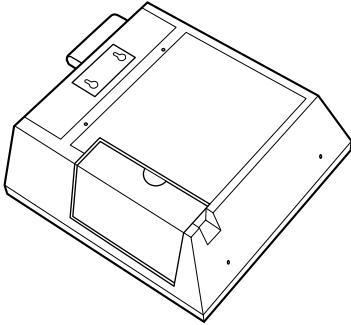

2. Place the stand so that the two pins on the lower bar of the stand fit into the holes on the lower surface of the MusicCAST client.

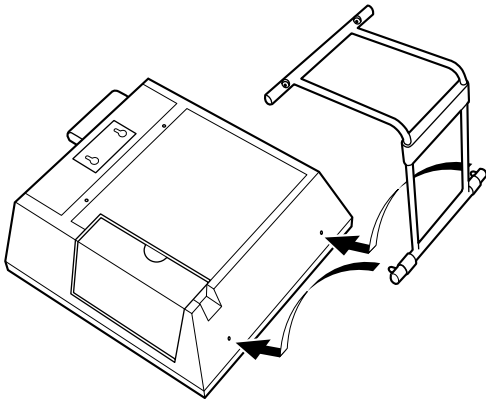

3. Using a screwdriver, attach the top bar of the stand to the MusicCAST with the provided screws.

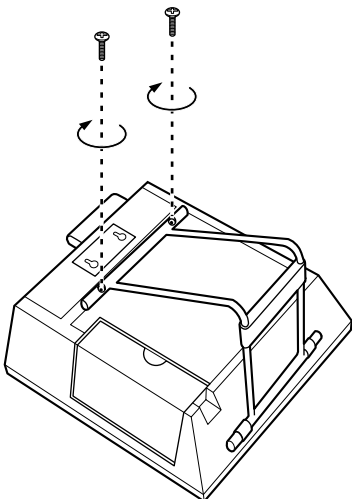

Mounting the MusicCAST client on a wall

1. Insert 2 self-tapping screws (diameter: 3.5 to 4 mm) into the wall, 40 mm apart.

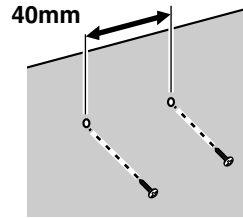

2. Mount the MusicCAST client on the screws by positioning it so that the screws on the wall fit snugly into the holes on the mounting bracket.

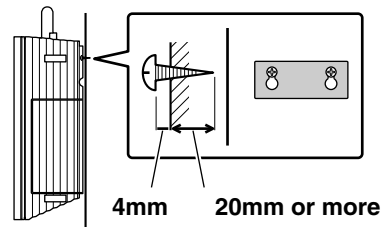

Cautions

- The MusicCAST client weighs 2 kg (4 lbs 6 oz). Do not mount it on thin plywood or a wall with soft surface material. If mounted, the screws may come loose from the flimsy surface and the speaker may fall. This damages the MusicCAST client and may cause personal injury.
- Do not use nails, adhesives, or other unstable materials to mount the MusicCAST client. Long-term use and vibrations may cause it to fall.
- To avoid accidents resulting from tripping over loose cables, fix it to the wall.

Removing the side-panel cover

1. Push the tab down firmly.

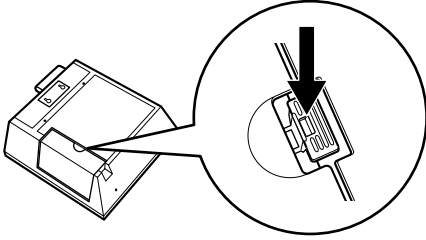

2. Slide the cover away from the MusicCAST client casing.

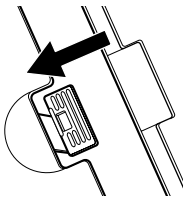

Remote control

- Loading the battery for the remote control

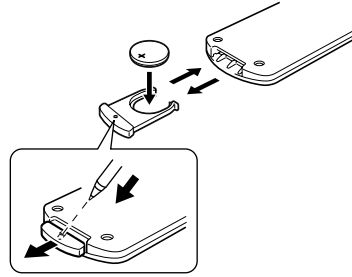

1. Slide out the battery holder from the remote control by pushing into the hole in the holder with a ball-point pen, etc.

Note

- The casing is very stiff, and may require significant pressure to remove.

2. Place the battery in the holder, positive side upward.
3. Slide the holder into the remote control.

■ Battery replacement

If you find that the remote control must be used closer to the main unit than usual, the battery is weak. Replace the battery with new one.

■ Notes on the lithium battery

Please take care when using the lithium battery as it may explode if mistreated.

- Never abuse or disassemble the battery.
- Be sure the battery polarity is correct. If it is not installed correctly, it may cause fire or explosion.
- Avoid placing the lithium battery and also the remote control with the battery installed, in high temperature such as direct sunlight.
- Do not recharge the battery.
- When replacing the battery, make sure to only use a CR2025 battery.
- Keep the battery out of reach of children. If swallowed, get immediate medical help.
- When disposing of the battery, insulate it with tape, etc. Never dispose of it in fire. Also, dispose of the battery according to local regulations.
- If the battery leaks, dispose of it immediately. Avoid touching the leaked material or letting it come in contact with clothing, etc. Skin contact may cause a burn. If it occurs, wash the affected area with water promptly and get medical attention.

■ Remote control operation range

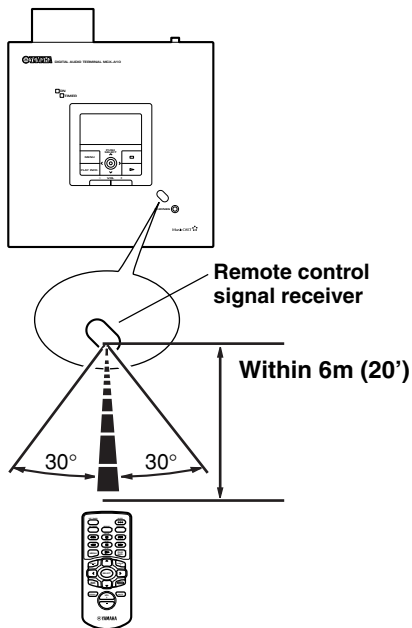

Cautions

- If operation of this unit by the remote control creates any malfunction in any other components, change the placement of the component.
- Do not spill any liquid on or drop the remote control. Do not place it near a heater or in the bathroom where the temperature and humidity become high.
- Make sure the remote control signal receiver is not exposed to direct sunlight or strong lights. Such exposure may inhibit the functioning of the remote control.

Connecting the AC adaptor

1. Insert the AC power cable into the AC adaptor.

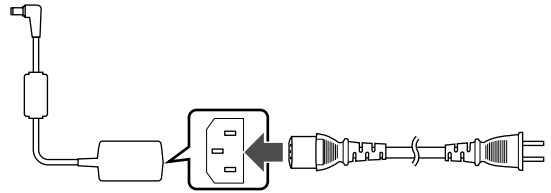

2. Connect the AC adaptor to the AC adaptor input on the MusicCAST client.

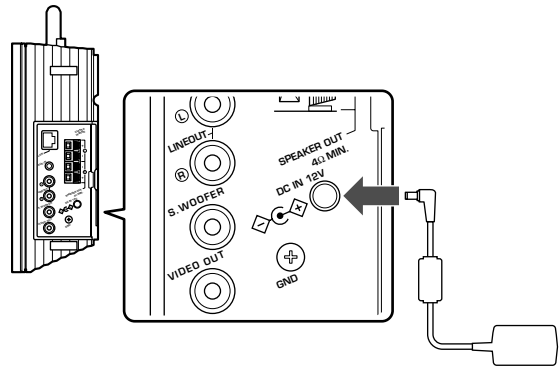

3. Plug in the AC power cable to an AC outlet.

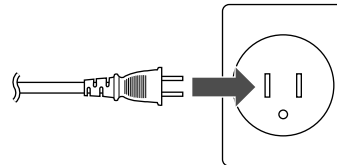

This picture depicts the style of AC outlet found in the United States of America.

Checking MusicCAST client connections

Before you attempt to use the MusicCAST client to play music, check the following:

- ❶ If you wish to listen to music with the MusicCAST client without using headphones, have you connected it to an external receiver, or to speakers?
- ❷ If you intend to connect to your MusicCAST server using the built in wireless network connection, have you placed the MusicCAST client within an appropriate distance of the server? (see page 23)
- ❸ If you intend to connect to your MusicCAST server using a wired network connection, have you connected your MusicCAST client to the server with a LAN cable to a hub?
- ❹ Is the MusicCAST server power turned on?
- ❺ Is the MusicCAST client connected to an AC outlet?
- ❻ Is the MusicCAST client power turned on?

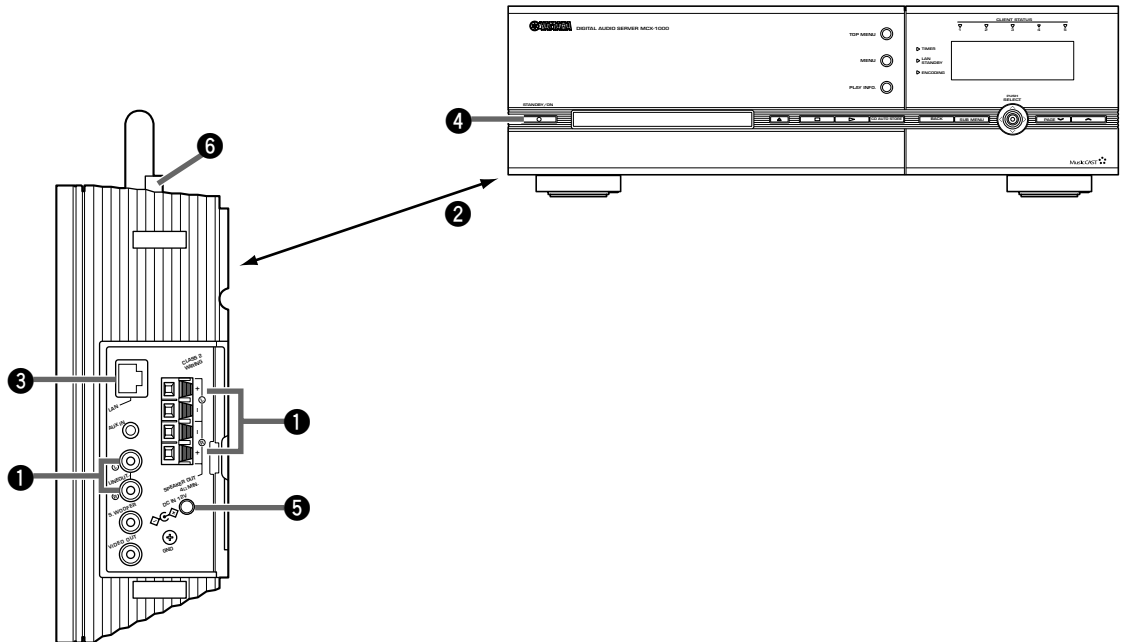

The MusicCAST network

The MusicCAST server stores all music data used in your MusicCAST system. The MusicCAST client does not store or record any music data. Your MusicCAST client uses a Local Area Network (LAN) to transmit and receive data from the MusicCAST server, which it then plays back as music.

The MusicCAST system can use both wired and wireless network connections to transmit music data. Both types of connections transmit the same data.

The wireless network in your MusicCAST system uses high frequency radio signals to transmit data. You do not need a physical connection between your MusicCAST server and clients to listen to music over a wireless network, but you need to place all clients in fairly close proximity to the server for them to work properly:

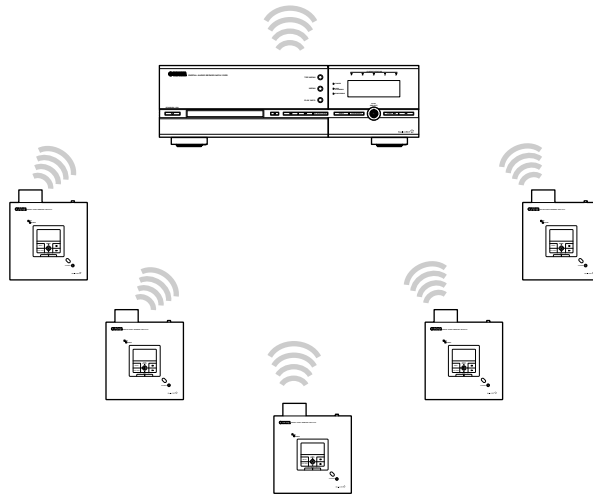

A wired network transmits data through a special type of cable, called a LAN cable. You must physically connect each MusicCAST client and server to a network router or hub with one of these cables. Connections using LAN cables functions without problems over much longer distances than connections using the wireless network used in the MusicCAST system.

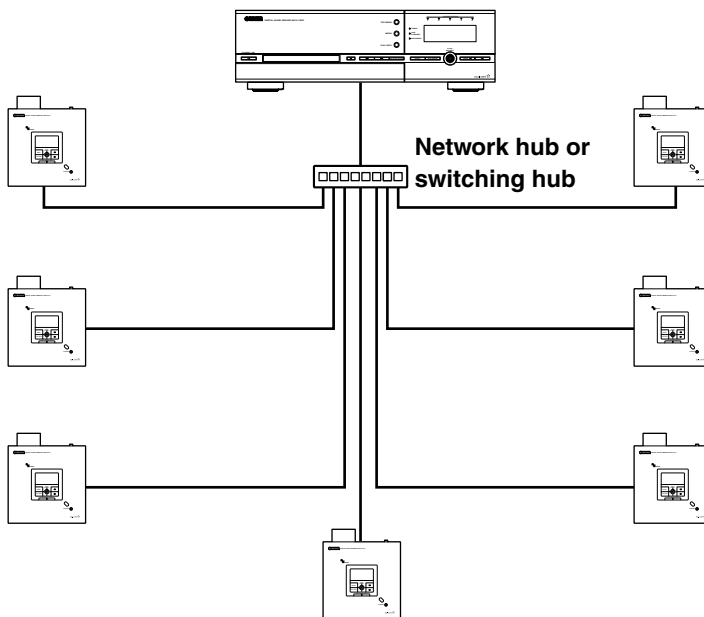

■ **Network addresses**

Each component on a network uses an address to identify itself to other components on the same network. The address consists of four numbers, and looks like this:

192.168.1.1

This is called an **IP address**. Without these addresses, the components on the network cannot transmit data to each other, and you cannot play music on your MusicCAST clients.

Look at the network diagram below to see an example of network addresses.

■ **Assigning IP addresses**

Before you begin to use a MusicCAST client, you must connect it to a MusicCAST server, assign it an IP address, and set the server ID of the MusicCAST server you wish to connect it to. Normally, you can use the Auto Configuration function for this connection process.

MusicCAST components are equipped with an Auto Configuration function that will automatically set all parameters necessary to make a connection, however in some rare cases you may need to configure the network settings manually.

See pages 25 – 34 for an explanation of how to configure a MusicCAST client to use a wireless LAN connection.

See pages 25 – 34 for an explanation of how to configure a MusicCAST client to use a wired LAN connection.

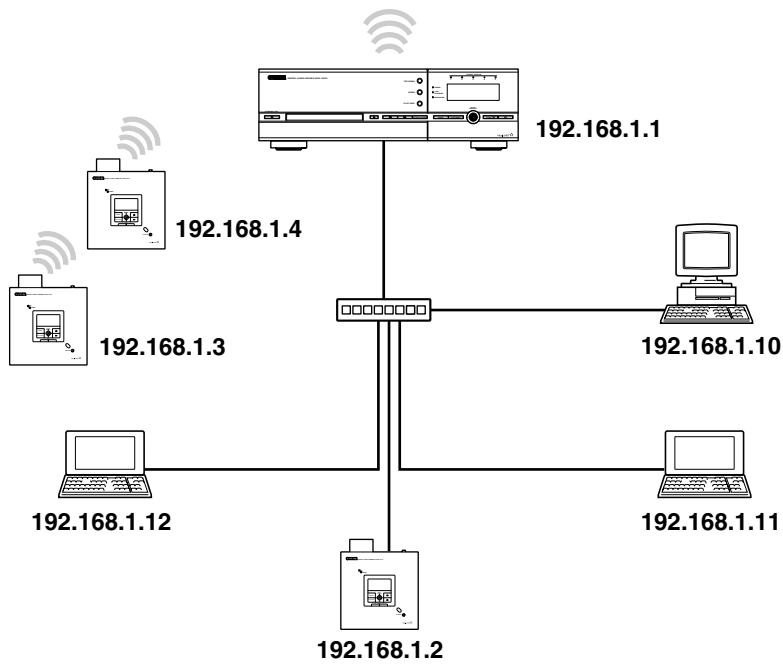

Wireless network connections

■ When and why should I use a wireless connection?

The wireless network technology in the MusicCAST system utilizes high frequency radio signals to transmit data between the various MusicCAST clients and the MusicCAST server. You can place clients anywhere you wish without physically connecting them to the MusicCAST server, so long as they are within transmitting range (approximately 30 meters if there are no obstructions between the MusicCAST server and client).

This means that you do not need to go to the effort of laying and connecting cables and can change the location of your MusicCAST clients at will.

Wireless connections are thus very convenient when there is enough signal strength for the client to transmit and receive data from the server reliably. However, since wireless network connections do not carry as much data as wired networks, the MusicCAST server can only distribute to five MusicCAST clients simultaneously using the wireless network.

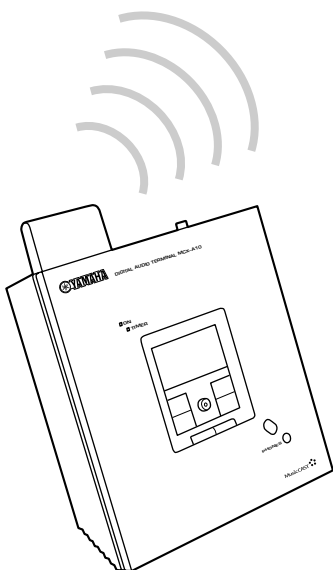

MusicCAST client

Note

- When using close to the maximum number of MusicCAST clients, the surrounding environment strongly affects the ability of the MusicCAST components to make wireless connections. To ensure stable playback in this situation, reduce the bitrate at which the MusicCAST server stores MP3 files before storing CDs (See page 121 in the MCX-1000 owner's manual).

Use wireless connections when:

- You do not want to install network cables
- You do not wish to use more than five MusicCAST clients
- Your MusicCAST clients are located close to the server

Note

- Walls, microwave ovens, and devices such as cellular telephones that transmit radio signals may interfere with or block the wireless network signals from your MusicCAST system. In these conditions, it is advisable to either relocate your MusicCAST client, or use a wired network connection to connect to the MusicCAST server.



MusicCAST server

Wired network connections

■ When should I use a wired connection?

Wired networks use cables (called a LAN cable) connected between components to transfer data to a central network component (network hub), which then transfers the data on to the appropriate destination. This means that you need to physically connect your MusicCAST clients and servers to a hub with LAN cables in order to use wired network connections.

While installing a MusicCAST system using wired network connections is more time consuming and requires more effort, wired networks can carry more data over a greater distance than wireless networks. The MusicCAST server supports simultaneous playback on seven MusicCAST clients over a wired network.

■ What is a hub, and why do I need one?

A network hub receives signals from multiple components on a network and sends directs them to the correct destination. This enables many components to transmit and receive data on the same network. We recommend that you use a broadband router if you wish to connect your MusicCAST components to the Internet.

Note

- You cannot use MusicCAST system components for any activity on a network that extends beyond the router.

Use wired connections when:

- You wish to use more than five MusicCAST clients simultaneously
- You wish to place a MusicCAST client at a significant distance from the server (see page 23 for details)
- You wish to place a MusicCAST client in an environment where there is a possibility of electronic interference with a wireless network signal (for example, close to a cellular phone charger)

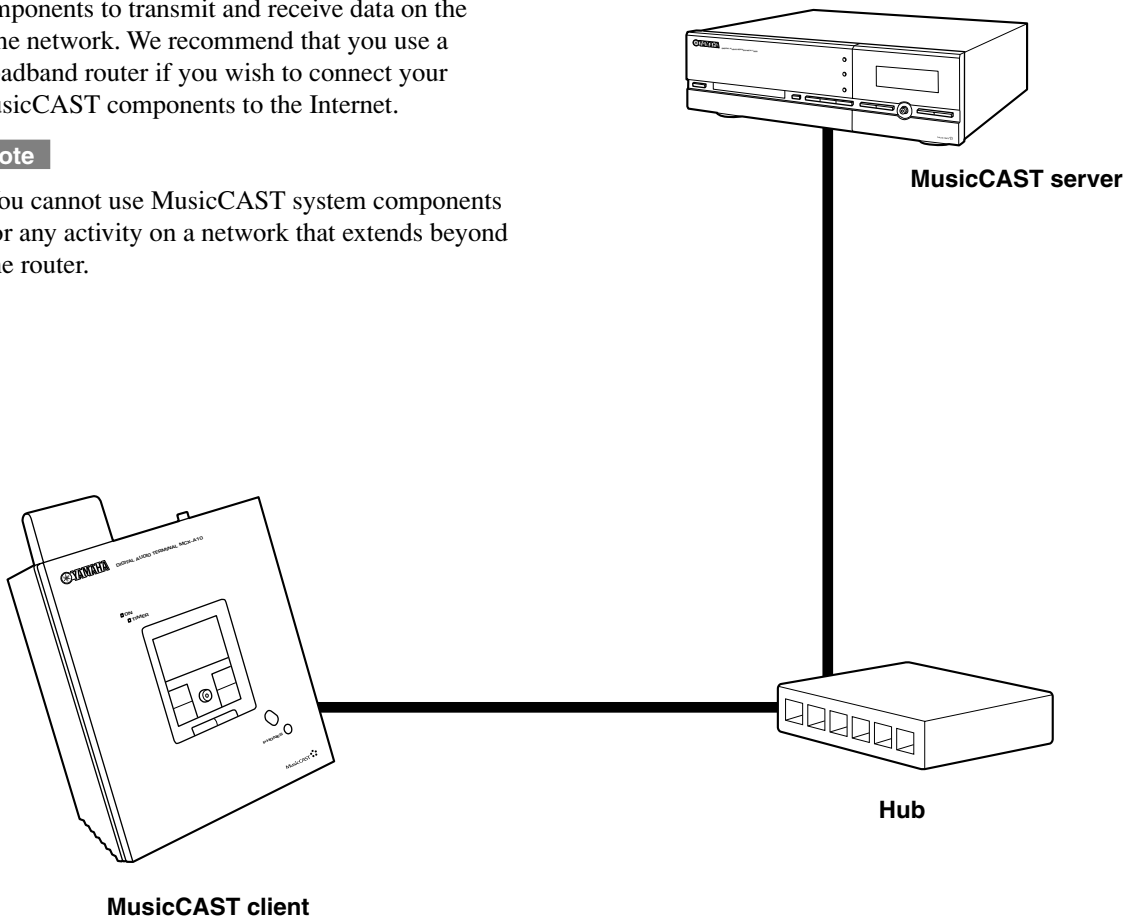

Connecting to the network

Place your MusicCAST client in a suitable location (See pages 23, 24 for an explanation of how location affects wired and wireless connections).

The MusicCAST client may function correctly even if the location you choose does not fit all of the requirements (described on pages 23, 24). However, the MusicCAST client requires a strong network signal to provide good quality playback, so it is advisable to try to place it in a location that meets the above definition as closely as possible.

Note

- Metal mounting racks may affect wireless network signals. Use wired network connections when mounting MusicCAST components in metal racks.

Configuring your MusicCAST client

There are two methods you can use to configure your MusicCAST client for wireless connection. In almost all cases, the Auto Configuration function will configure your MusicCAST client correctly and automatically establish a connection. In some specific cases, such as when you wish to use specific IP addresses for each MusicCAST client, you should configure the MusicCAST client manually.

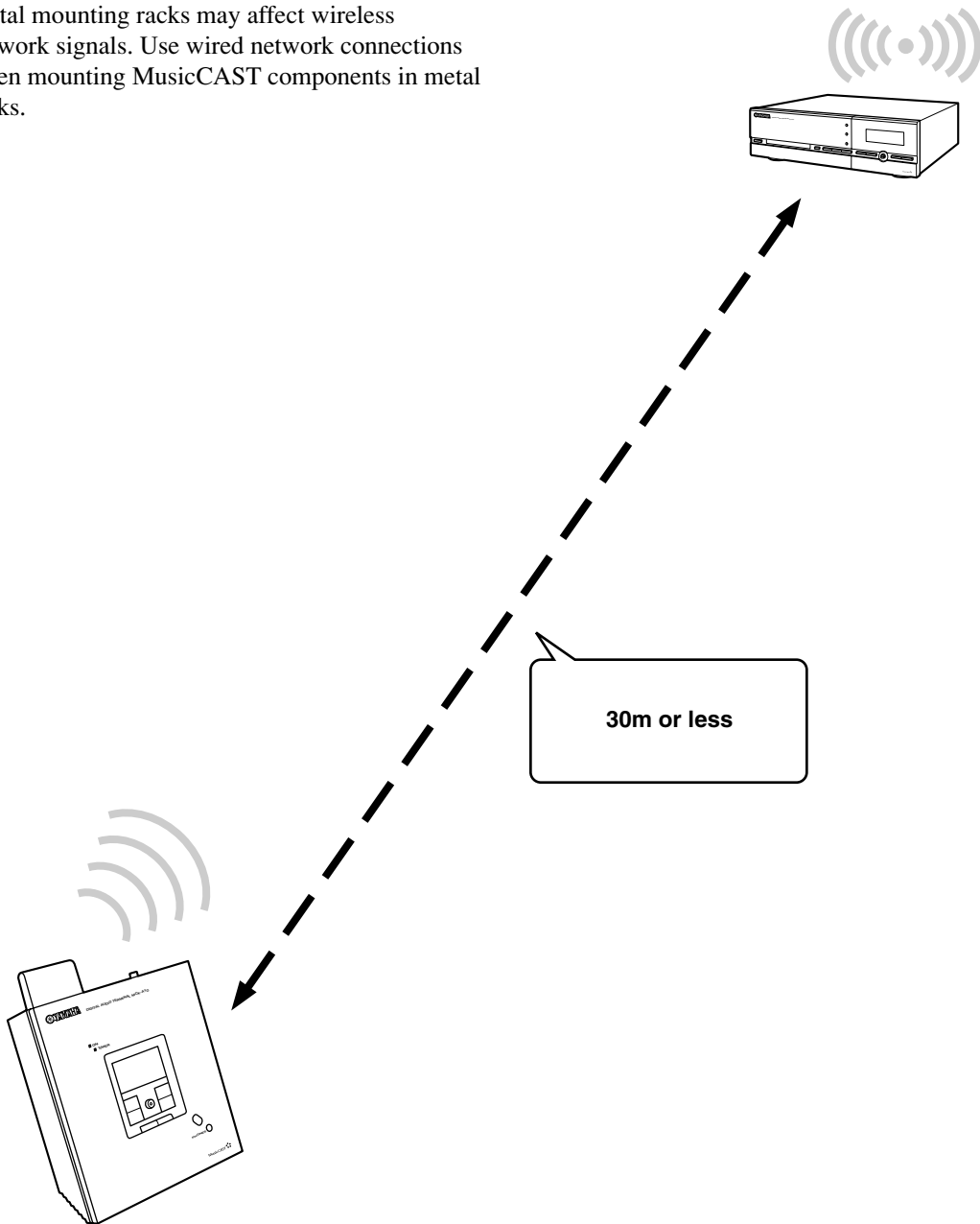

Using the Auto Configuration function

The Auto Configuration function automatically connects your MusicCAST client to a MusicCAST server. Before attempting to use the Auto Configuration function, carry out the following actions:

- Set the MusicCAST server in Auto Configuration mode (see the MCX-1000 owner's manual for details).
- If you wish to connect to a MusicCAST server over a wireless network, check that the MusicCAST client is close enough to the server to receive a wireless network signal (see page 23 for details).
- Check that the MusicCAST client is connected to an AC outlet.

Carry out the following procedure to configure the MusicCAST client.

This explanation uses the controller on the MusicCAST client.

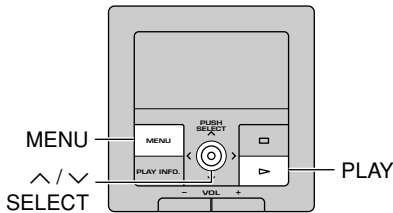

1. Press and hold MENU for two seconds to return to the Top Menu screen.



2. Use the controller on the MusicCAST client to move the cursor to "Setup", then press the controller.

The Setup screen appears on the display.



3. Use the controller on the MusicCAST client to move the cursor to "Network", then press the controller.

The Network screen appears on the display.

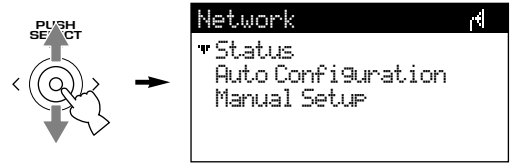

4. Use the controller on the MusicCAST client to move the cursor to "Auto Configuration", then press the controller.

The Auto Configuration prompt appears on the display.



5. Press PLAY.

The Auto Configuration process begins.



If more than one MusicCAST server is in close proximity AND in Auto Configuration mode, check the on-screen display of the MusicCAST server to verify that it is displaying the client ID of your MusicCAST client (this may take a few minutes).



6. Press the controller on the MusicCAST client.

The client attempts to connect to the server.



7. On the MusicCAST server, use ^ / \ / < / > to move the cursor to "OK" and press SELECT.

The following screen appears on the display of the MusicCAST client.



The MusicCAST server can only connect to seven MusicCAST clients simultaneously, and does not attempt to connect to other clients if it already has seven clients registered. To remove unwanted MusicCAST clients, use ^ / \ / < / > to move the cursor on the MusicCAST server on-screen display to a client ID, then move the cursor to "CLR" and press SELECT. When finished removing clients, move the cursor to "OK" and press SELECT. Carry out Auto Configuration again to connect the MusicCAST to other MusicCAST clients.

Configuring your MusicCAST client manually

Usually, the Auto Configuration functions of the MusicCAST server and client will enable you to successfully connect all of your MusicCAST components. However, you can also use the screens detailed in this section to configure the MusicCAST network manually if necessary. This section of this manual (see pages 25 – 34) explains how to set each network parameter in the MusicCAST client.

Carry out the following actions, before attempting to configure your MusicCAST client:

- If you wish to connect to a MusicCAST server over a wireless network, check that the MusicCAST client is close enough to the server to receive a wireless network signal (see page 23 for details)
- Check that the MusicCAST client is connected to an AC adaptor that is connected to an AC outlet
- Turn the MusicCAST server power on
- Turn the MusicCAST client power on

Confirm that the following have been set on the MusicCAST server:

- The Client IDs of all of the MusicCAST clients that you wish to use on the network (See pages 67, 68 for an explanation of how to check the Client ID of your MusicCAST client)
- The ESS ID of the wireless network, if you plan to use wireless network connections
- The Subnet Mask address
- The WEP key

To configure the client you must set the parameters listed below from the Network menu. The order in which you set the parameters is unimportant, but you should ensure that you carry out each procedure correctly.

- Network mode
- ESS ID
- Server ID
- IP Address (for the MusicCAST client) (This is not necessary if you are using the MusicCAST client in a network with a component acting as a DHCP server, or if your MusicCAST server is set to act as a DHCP server)
- WEP key
- Subnet Mask

Note

- The MusicCAST server and MusicCAST client only function correctly if they are under the same subnet running under one or more network hubs.

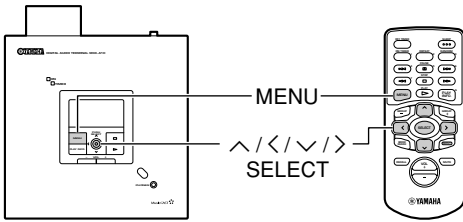

■ Accessing the Manual Setup screen

1. Press and hold MENU for two seconds to return to the Top Menu screen.



2. Use \wedge / \vee to move the cursor to “Setup” and press SELECT.

The Setup screen appears on the display.

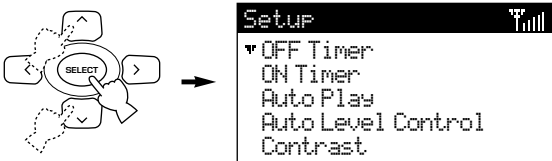

3. Use \wedge / \vee to move the cursor to “Network” and press SELECT.

The Network screen appears on the display.

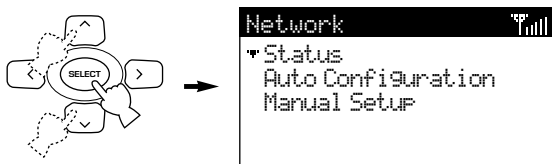

4. Use \wedge / \vee to move the cursor to “Manual Setup” and press SELECT.

The Manual Setup screen appears on the display.

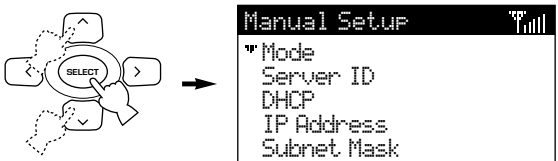

■ Setting the Network Mode

1. From the Manual Setup menu, use \wedge / \vee to move the cursor to “Mode” and press SELECT.

The Mode screen appears on the display.

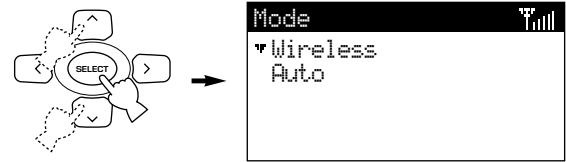

2. If you wish to configure the MusicCAST client to use a wireless connection, use \wedge / \vee to move the cursor to “Wireless” and press SELECT, then press PLAY at the prompt.

The MusicCAST client restarts and returns to the Top Menu screen.

If you wish to configure the MusicCAST client to use a wired connection, use \wedge / \vee to move the cursor to “Auto” and press SELECT, then press PLAY at the prompt.

The unit selects a wired connection if one is available, and returns to the default wireless connection if one is not. The MusicCAST client restarts and returns to the Top Menu screen.



■ Setting the ESS ID

All wireless networks work by using weak high frequency radio signals to transmit data between the various components using the same “channel” on the network. Each “channel” has an identification code, called an ESS ID. Only items with the same ESS ID transmit data to each other.

If you do not wish to use a wireless connection, skip this section and move to the section on setting the IP address.

- 1. If you wish to use a wireless connection, from the Manual Setup menu, use the \wedge / \vee to move the cursor to ESS ID and press SELECT.**

The ESS ID screen appears on the display.

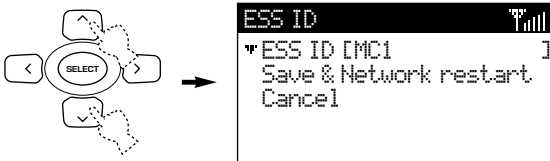

- 2. Press SELECT.**

The cursor enters the ESS ID setting field.

You need to enter the same ESS ID you have set on the MusicCAST server.

- 3. Use \wedge / \vee to select the desired character, then press \langle / \rangle to move the cursor to the left or right.**

- 4. When you finish entering the ID, press SELECT to confirm the setting.**

The cursor returns to the left of the “ESS ID” parameter.

- 5. If you are satisfied with the settings you have made, move the cursor to “Save & Network restart” and press SELECT.**

This confirms the settings and restarts the network hardware on the MusicCAST client. Alternatively, select “Cancel” to exit from the menu without saving and confirmation.

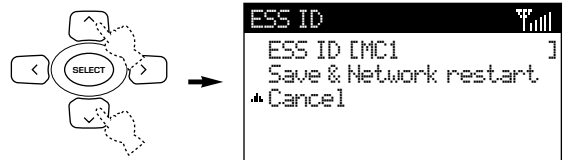
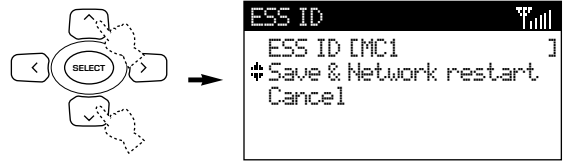

■ Setting your MusicCAST client to act as a DHCP client

If you set your MusicCAST client to act as a DHCP client, it automatically receives a new IP address from the network DHCP server each time you turn it on. This is useful if you do not want to pre-set an IP address for each MusicCAST client in your system. The MusicCAST client is set to be a DHCP client by default.

Notes

- The MusicCAST client must be connected to a network with an active DHCP server if you wish it to act as a DHCP. The MusicCAST server can act as a DHCP server if you set it to so. See page 110 in the MCX-1000 owner's manual for more information.
- If you are using a DHCP server other than the MusicCAST server when using the MusicCAST client as a DHCP client, you may sometimes need to reset the IP address the MusicCAST client is receiving from the DHCP server. Stop all activity on MusicCAST clients while doing this. For more information see the section of your DHCP server's owner's manual that deals with the expiration of IP addresses.

1. From the Network Menu, use \wedge / \vee to move the cursor to "Manual Setup" and press SELECT.

The Manual Setup screen appears on the display.

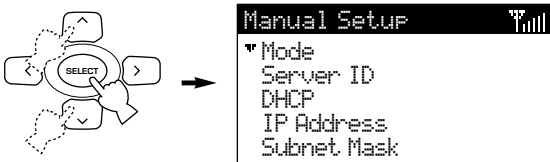

2. Use \wedge / \vee to scroll the menu to "DHCP" and press SELECT.

The DHCP screen appears on the display.

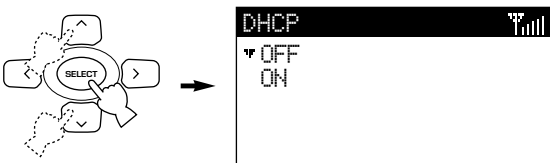

3. Use \wedge / \vee to scroll the cursor to the appropriate setting and press SELECT.

- OFF: The MusicCAST client does not act as a DHCP client and only uses a preset IP.
- ON: The MusicCAST client attempts to use DHCP to obtain a new IP address from the MusicCAST server each time you switch it on.

■ **Setting the MusicCAST server Server ID**

1. From the Manual Setup menu, use \wedge / \vee to move the cursor to “Server ID” and press **SELECT**.

The Server ID screen appears on the display.

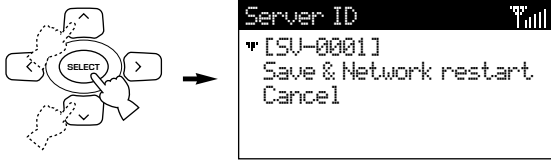

2. Press **SELECT**.

The cursor enters the Server ID setting field. You need to enter the same address here as your MusicCAST server has set as its Server ID. See page 112 in the MCX-1000 owner’s manual for an explanation of how to view the Server ID of your MusicCAST server.

3. Use \wedge / \vee to select the desired character, then press \langle / \rangle to move the cursor to the left or right.

4. When you finish entering the ID, press **SELECT** to confirm the setting.

The cursor returns to the left of the Server ID setting field.

5. If you are satisfied with the settings you have made, move the cursor to “Save & Network restart” and press **SELECT**.

This confirms the settings and restarts the network hardware on the MusicCAST client. Alternatively, select “Cancel” to exit from the menu without saving and confirmation.

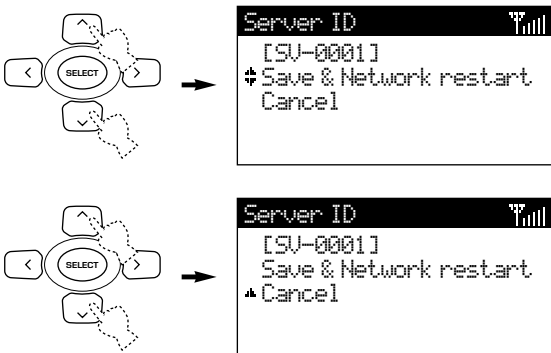

■ **Setting the MusicCAST client IP Address**

1. From the Manual Setup menu, use \wedge / \vee to move the cursor to “IP Address” and press **SELECT**.

The IP Address screen appears on the display.

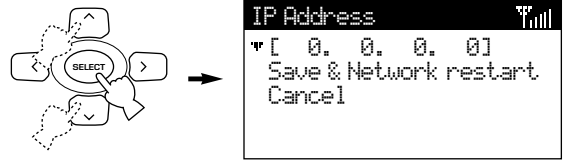

2. Press **SELECT**.

The cursor enters the IP address setting field.

Note

- This setting is only valid when the MusicCAST client is not set to act as a DHCP client (see page 31 for an explanation of how to do this).

3. Use \wedge / \vee to select the desired 3 digit IP number, then press \langle / \rangle to move to the next number to set.

4. When you have set all four numbers, press **SELECT** to confirm the setting.

The cursor returns to the left of the IP address setting field.

5. If you are satisfied with the settings you have made, move the cursor to “Save & Network restart” and press **SELECT**.

This confirms the settings and restarts the network hardware on the MusicCAST client, returning the display to the Network menu. Alternatively, select “Cancel” to exit from the menu without saving and confirmation.

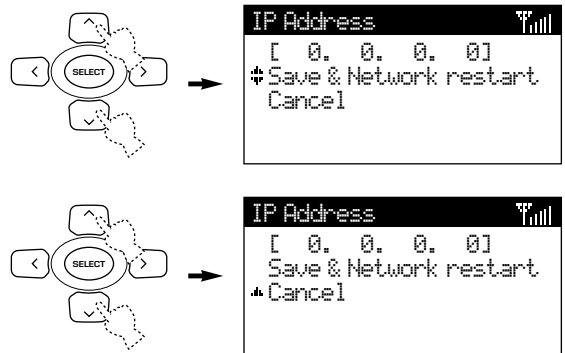

■ Setting the Subnet Mask Address

1. From the Manual Setup menu, use \wedge / \vee to move the cursor to “Subnet Mask” and press **SELECT**.

The Subnet Mask screen appears on the display.

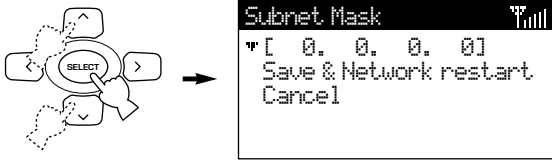

2. Press **SELECT**.

The cursor enters the IP address setting field. You need to enter same subnet mask IP address here that you have set on the MusicCAST server. Refer to the “Status view” screens on the MusicCAST server On Screen Display for the correct address.

3. Use \wedge / \vee to select the desired 3 digit IP number, then press \langle / \rangle to move to the next number to set.

4. When you have set all four numbers, press **SELECT** to confirm the setting.

The cursor returns to the left of the IP address setting field.

5. If you are satisfied with the settings you have made, move the cursor to “Save & Network restart” and press **SELECT**.

This confirms the settings and restarts the network hardware on the MusicCAST client, returning the display to the Network menu.

Alternatively, select “Cancel” to exit from the menu without saving and confirmation.

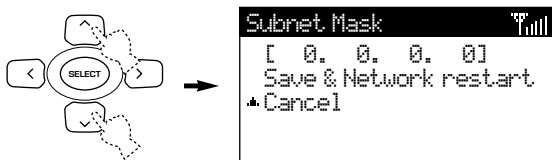
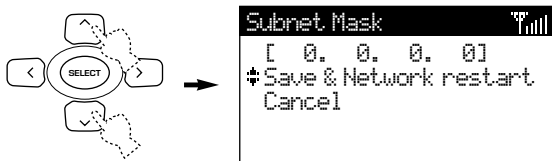

Note

- This setting is only valid when the MusicCAST client is not set to act as a DHCP client (see page 31 for an explanation of how to do this).

■ Setting the WEP key for your MusicCAST client

In order for your MusicCAST client and server to share data over a wireless network, you must give them both the same encryption key (WEP key). Refer to the MusicCAST server main manual for an explanation of how to set this key on the MusicCAST server.

1. From the Manual Setup menu, use \wedge / \vee to scroll the menu to “WEP key” and press **SELECT**.

The WEP key screen appears on the display.

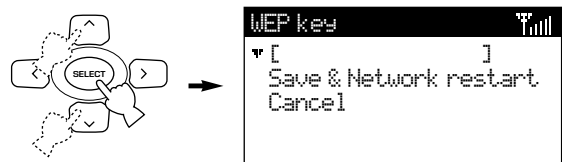

2. Press **SELECT**.

The cursor enters the WEP key setting field. You need to enter the characters here as you have set in the WEP key field on the MusicCAST server.

3. Use \wedge / \vee to select the desired character, then press \langle / \rangle to move the cursor to the left or right.

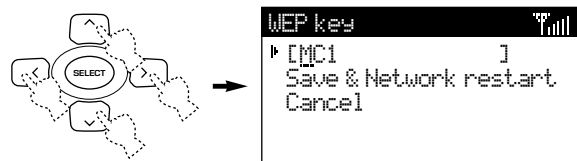

Note

- The MusicCAST network uses 128-bit encryption, which requires a 13-digit WEP key. If you enter less than 13 digits, the MusicCAST client automatically adds zeroes to the code you set to make up the difference.

4. When you finish entering the key, press **SELECT** to confirm the setting.

The cursor returns to the left of the WEP key setting field.

5. If you are satisfied with the settings you have made, move the cursor to “Save & Network restart” and press SELECT.

This confirms the settings and restarts the network hardware on the MusicCAST client, returning the display to the Network menu. Alternatively, select “Cancel” to exit from the menu without saving and confirmation.

■ Connection check

If you have carried out the setting procedure correctly and the MusicCAST client has achieved a connection, the connection icon appears at the top right of the on screen display:

For wired network connections



For wireless network connections



The bars on the right of the wireless network signal icon indicate the strength of the network signal. One bar indicates a weak signal, five bars indicates a maximum strength signal.

The following icon indicates that the MusicCAST client is not able to connect to the MusicCAST server. Try the network setting procedure again, or refer to the troubleshooting section on page 69.



Music playback on the MusicCAST client

The MusicCAST client can playback music stored in a MusicCAST server over a wired or wireless network. Two kinds of files are available for playback: MP3 (MPEG-1 Audio Layer 3), and PCM (Pulse Code Modulation). PCM files give better sound quality, but can only be played back on one MusicCAST client at a time. On some screens the MusicCAST client may display a “*” beside some song names. The songs are not available for playback unless you have specifically designated your MusicCAST server to distribute PCM files to this MusicCAST client. See page 125 in the MCX-1000 owner’s manual.

The MusicCAST system stores its music data as follows:

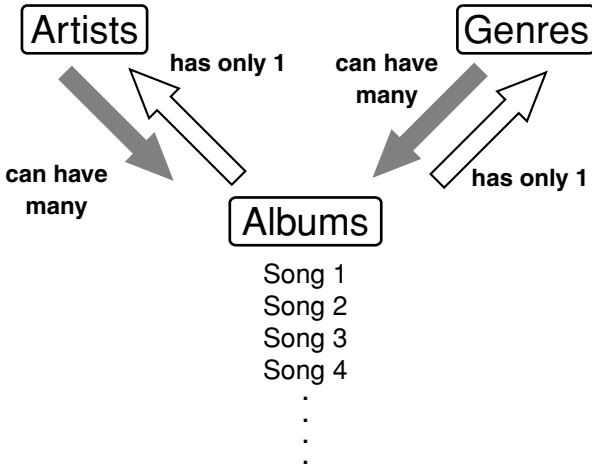

You can play songs stored in the MusicCAST server by :

- Selecting a specific artist
- Selecting a specific album
- Selecting a genre
- Letting your MusicCAST client playback a random selection of songs
- Selecting a pre-chosen list of songs (a playlist) to listen to
- Playing songs from a bookmarked location on your MusicCAST server

■ Playback groups

The selection criteria you use to choose a song for playback also defines the playback group. For example, selecting an album from the Album menu for playback sets album as the playback group and plays back all songs in the album. Playback continues in the order the songs are registered, or in alphabetical order depending on the playback group setting. Playback group also defines the limits within which the Random Playback, Repeat Playback, and Song Skip functions operate.

Use GROUP+ to skip to the next item (for example, “Album” in the playback group, or GROUP– to skip to the previous item.

Note

- Sometimes GROUP– and GROUP+ appear to have no effect on the MusicCAST client. This is because there are no more items registered to the playback group. For example, pressing GROUP+ when the playback group is “albums of artist” and no other albums are registered to the artist has no effect on the MusicCAST client.

■ **During playback**

The Play Info screen appears on the display when the MusicCAST client is playing a song, unless you perform an operation with the remote control. Press PLAY INFO to return to this screen.



Press > to access the available playback styles. To alter the setting of a particular parameter, press SELECT. Use ^ / v to change the setting, and SELECT to confirm the setting you select. Press < to exit from the Play Style screen. The parameters available are:

• **Repeat (OFF, SINGLE, ALL)**

Depending on the setting of this parameter, the MusicCAST client repeats playback of a selected item.

- OFF: No repeat
- SINGLE: The MusicCAST client repeats playback of the current song.
- ALL: The MusicCAST client repeats playback of the current group.

• **Random (OFF, ON)**

If this parameter is set to ON, the unit continuously plays a random sequence of tracks until playback is halted. The songs the MusicCAST client targets for playback depend how you select the song you want to listen to. If you select playback from an album, then all tracks on that album are targeted for playback, if you have selected an artist, then all tracks from that artist are targeted, and so on.

• **Group (ALL, SINGLE)**

Sets the group playback function (see pages 45, 46).

- ALL: The MusicCAST client begins playback of the next group when playback of the present group finishes.
- SINGLE: The MusicCAST client halts playback when playback of the present group finishes.

• **Bookmark (OFF, ON)**

If this parameter is set to ON, the current song is added to the bookmark list (see pages 52 – 55).

• **Time (ELAP, REM)**

These parameters alter the manner in which the MusicCAST client displays time on the Play Info screen.

- ELAP: (Elapsed)
Displays the time elapsed since you started playback of the current song.
- REM: (Remaining)
Displays the time remaining until the end of the current song.

Skipping to a different song

Press >>> to skip to the next song, or press <<< once to return to the beginning of the currently playing song or twice to skip to the beginning of the previous song during playback.



Searching forward or backward within a song

To search forward, press >>>, and to search backward, press <<<, during playback. The MusicCAST client does not output any sound during these operations.



Note

- You cannot skip or search through songs when playback is paused.

To play a song from an artist

Use this option to directly access the songs by a particular artist stored in your MusicCAST server. All songs and albums assigned to this artist are available for selection.

Carry out the following procedure to play a specific song from albums assigned to a particular artist.

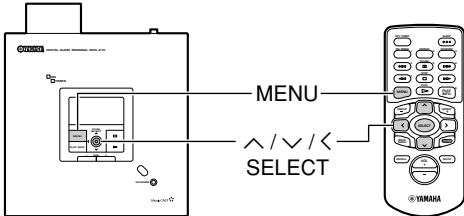

1. Press and hold MENU for two seconds to return to the Top Menu screen.



2. Use ^ / v to move the cursor to "Play" from the Top Menu and press SELECT.
The Play Menu screen appears on the display.



3. Use ^ / v to move the cursor to "Artists" and press SELECT.
The display lists all artists currently stored in the MusicCAST server, in alphabetical order.



4. Use ^ / v to move the cursor to the name of the artist you wish to select.
Moving the cursor to the bottom of the screen causes the display to scroll upwards, while moving it to the top of the screen makes the display scroll downwards. Press SELECT to display all the albums assigned to the artist, or press > to begin playback of all songs from the selected artist in alphabetical order.



5. Use ^ / v to move the cursor to the name of the album you wish to open.
Press SELECT to display all the songs on the album, or press > to begin playback of the entire album.



6. Use ^ / v to select a specific song to listen to.



7. Press SELECT to begin playback of the selected song.
The Play Info screen appears on the display.



Press < to return the list screen.

■ **To stop playback**

Press **□**.

■ **To halt playback temporarily**

Press **⏏**. Press **⏏** again to resume playback.

Note

- Once playback of the song is finished, the MusicCAST client begins playback of the next song stored as part of that album on the MusicCAST server.

To play a song from an album

Use this option to directly access the songs on a particular album stored in your MusicCAST server. All songs assigned to this album are available for selection.

Carry out the following procedure to playback a specific song from a specific album.

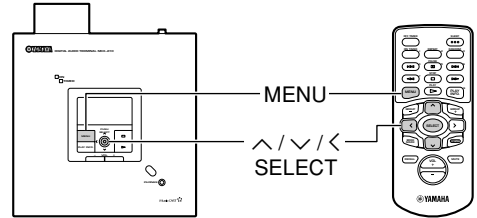

- 1. Press and hold MENU for two seconds to return to the Top Menu screen.**



- 2. Use ^ / v to move the cursor to “Play” from the Top Menu screen and press SELECT.**

The Play Menu screen appears on the display.



- 3. Use ^ / v to move the cursor to “Albums” and press SELECT.**

The display lists all albums stored in the MusicCAST server, in alphabetical order.

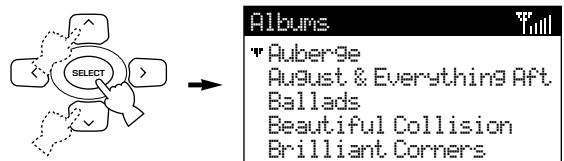

4. Use ^ / v to move the cursor to the name of an album.

Moving the cursor to the bottom of the screen causes the display to scroll upwards, while moving it to the top of the screen makes the display scroll downwards. Press SELECT to display all the songs on the album, or press PLAY to begin playback of the album.



5. Use ^ / v to select a song.



6. Press SELECT to begin playback of the selected song.

The Play Info screen appears on the display.



Press < to return the list screen.

■ To stop playback

Press [STOP].

■ To halt playback temporarily

Press [PAUSE]. Press [PAUSE] again to resume playback.

Note

- Once playback of the song you select is finished, the MusicCAST client begins playback of the next song stored as part of that album on the MusicCAST server.

To play a song from a genre

Use this option to directly access the songs of a particular genre stored in your MusicCAST server. All songs and albums assigned this genre are available for selection.

Carry out the following procedure to playback a specific song from the albums assigned to a particular genre.

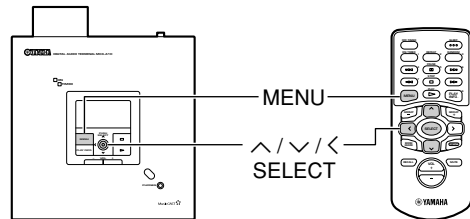

1. Press and hold MENU for two seconds to return to the Top Menu screen.



2. Use ^ / v to move the cursor to "Play" from the Top Menu screen and press SELECT.

The Play Menu screen appears on the display.



3. Use ^ / v to move the cursor to "Genres" and press SELECT.

The display lists all genres stored in the MusicCAST server, in alphabetical order.



4. Use ^ / v to move the cursor to the name of the genre you wish to select.

Moving the cursor to the bottom of the screen causes the display to scroll upwards, while moving it to the top of the screen makes the display scroll downwards. Press SELECT to display all the albums assigned to the selected genre, or press PLAY to begin playback of all songs from the selected genre in alphabetical order.

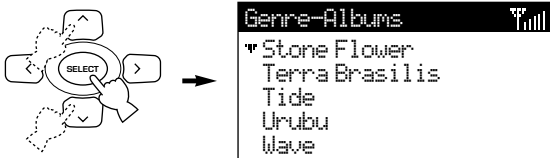

5. Use ^ / v to move the cursor to the name of the album you wish to open.

Press SELECT to display all the songs on the album, or press PLAY to begin playback of the album.

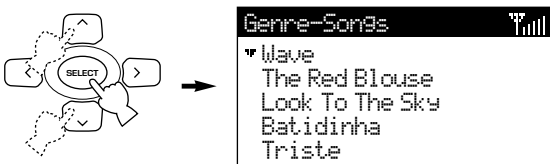

6. Press SELECT to begin playback of the selected song.

The Play Info screen appears on the display.



Press < to return the list screen.

■ To stop playback

Press □.

■ To halt playback temporarily

Press ◻◻. Press ◻◻ again to resume playback.

Note

- Once playback of the song you select is finished, the MusicCAST client begins playback of the next song in alphabetical order in the genre.

To select a song from the complete list of songs

Use this option to directly access all of the songs in the MusicCAST database without selecting an Artist, Album, or Genre first.

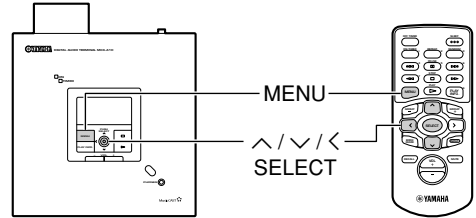

Carry out the following procedure to select and playback a song from the complete list of songs stored in the MusicCAST server.

1. Press and hold MENU for two seconds to return to the Top Menu screen.



2. Use ^ / v to move the cursor to "Play" from the Top Menu screen and press SELECT.

The Play Menu screen appears on the display.



3. Use ^ / v to move the cursor to "All Songs" and press SELECT.

The display lists all songs stored in the MusicCAST server, in alphabetical order.

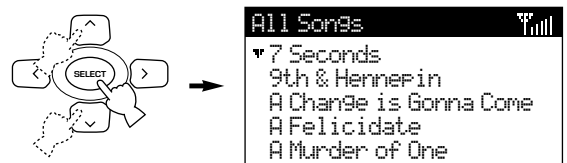

4. Use ^ / v to move the cursor to the name of a song.

Moving the cursor to the bottom of the screen causes the display to scroll upwards, while moving it to the top of the screen makes the display scroll downwards.



5. Press SELECT to begin playback of the selected song.

The Play Info screen appears on the display.



Press < to return the list screen.

■ To stop playback

Press □.

■ To halt playback temporarily

Press ▢. Press ▢ again to resume playback.

Note

- Once playback of the song you select is finished, the MusicCAST client begins playback of the song that is stored next in alphabetical order on the MusicCAST server.

Using Playlists

Playlists are collections of songs grouped together and registered by the users of your MusicCAST server. You cannot create or alter playlists from the MusicCAST client, but you can access them for playback. See page 41 in the MCX-1000 owner's manual for more information on playlists.

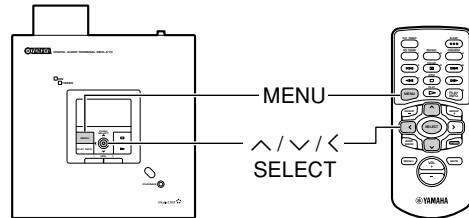

■ Accessing playlists with your MusicCAST client

Carry out the following procedure to access songs in pre-existing playlists stored on your MusicCAST server:

1. Press and hold MENU for two seconds to return to the Top Menu screen.



2. Use ^ / v to move the cursor to "Play" and press SELECT.

The Play Menu screen appears on the display.



3. Use ^ / v to move the cursor to "Playlists" and press SELECT.

The Playlists screen appears on the display.



4. Use ^ / v to move the cursor to highlight the collection of playlists you want to select and press SELECT.

The display changes to show the playlists registered to this collection. Press ▷ if you want to playback all playlists in a collection.

5. Use ^ / v to move the cursor to highlight the playlist you want to select and press SELECT.

The display changes to show the tracks registered to this playlist. The MusicCAST client displays an “L” beside album, an “A” beside artists, and a “G” beside genres that are linked to the playlist. Press ▷ if you want to playback all songs in a playlist.



6. Use ^ / v to move the cursor to the name of a song.

Moving the cursor to the bottom of the screen causes the display to scroll upwards, while moving it to the top of the screen makes the display scroll downwards.

7. Press SELECT to begin playback of the selected song.

The Play Info screen appears on the display.



Press < to return the list screen.

■ To stop playback

Press □.

■ To halt playback temporarily

Press ▢. Press ▢ again to resume playback.

Notes

- Once playback of the song you select is finished, the MusicCAST client begins playback of the next song in the playlist.
- The MusicCAST client can only play playlists if the MusicCAST server has registered playlists.

Song Statistics

The Song Statistics screen is a display of statistically significant data on the tracks and albums stored in the MusicCAST server, which you can access for playback.

- Times played:
Displays songs in order of the number of times they have been played.
- Recently played songs:
Displays songs in order from the most recently played.
- Recently stored albums:
Displays albums in order from the most recently recorded.

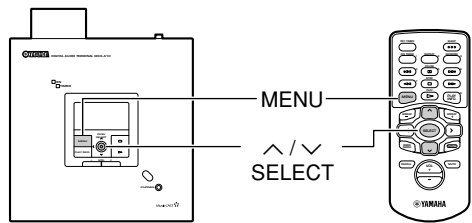

To access the Song Statistics screen, carry out the following procedure:

1. Press and hold MENU for two seconds to return to the Top Menu screen.



2. Use ^ / v to move the cursor to “Play” and press SELECT.

The Play Menu screen appears on the display.



3. Use ^ / v to move the cursor to “Song Statistics” and press SELECT.

The Song Statistics screen appears on the display.

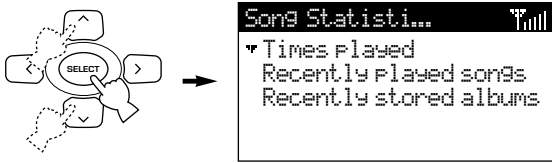

4. Use ^ / v to move the cursor to the criteria you want to use and press SELECT.



5. Use ^ / v to move the cursor to a song on Album and press SELECT.

Playback of the song you select begins.

Note

- If you selected an album in step 4, you need to select a song and press SELECT first.

To play a song in the list of bookmarks

The MusicCAST system can store a list of songs for each MusicCAST client (see pages 52 – 55), for easy access and playback. Carry out the following procedure to access this list.

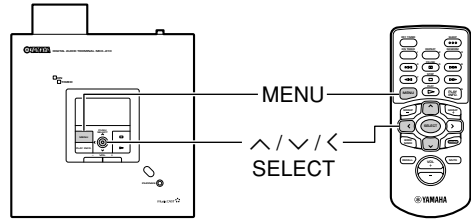

1. Press and hold MENU for two seconds to return to the Top Menu screen.



2. Use ^ / v to move the cursor to “Play” and press SELECT.

The Play Menu screen appears on the display.



3. Use ^ / v to move the cursor to “Bookmarks” and press SELECT.

The Bookmarks screen appears on the display.

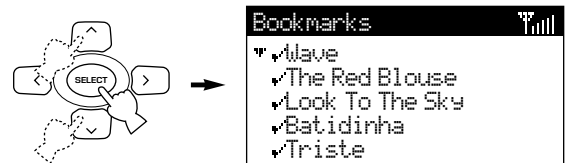

4. Use ^ / v to move the cursor to the name of a song.

Moving the cursor to the bottom of the screen causes the display to scroll upwards, while moving it to the top of the screen makes the display scroll downwards.

5. Press SELECT to begin playback of the selected song.

The Play Info Screen appears on the display.
Press < to return the list screen.

■ To stop playback

Press □.

■ To halt playback temporarily

Press ▢. Press ▢ again to resume playback.

Note

- Once playback of the selected song is complete, the MusicCAST client begins playback of the next song in the bookmark list.

Random Playback

When you utilize the Random Playback function, the MusicCAST client plays tracks in random order from the current playback group.

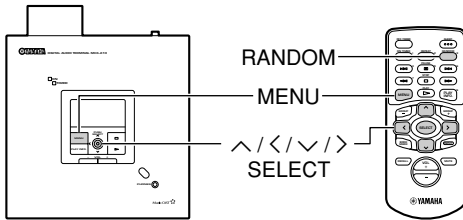

You can activate the Random Playback function by pressing RANDOM on the remote control. The MusicCAST client targets tracks for playback in accordance with the current setting of the Group parameter accessible by following the procedure on this page.

To select an entire group for random playback, begin playback from one level higher up the “Menu tree” than you would otherwise. For example, to playback all of the songs from an artist at Random rather than from one particular album, press PLAY with the cursor on the Artist name in the Artist selection screen, then set the MusicCAST client in Random Playback mode.



■ To use the Random Playback function

1. Begin playback of a track (see pages 35 – 44).

The Play Info screen appears on the display.

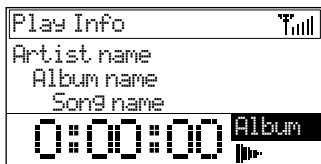

2. Press >.

The Play Style screen appears on the display.

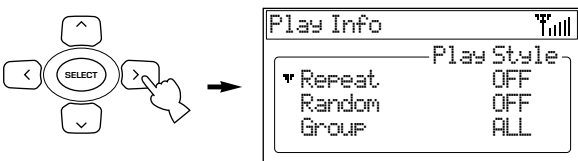

3. Use ^ / v to move the cursor to “Random” and press SELECT.

The cursor moves so that it is displayed under the “Random” parameter setting.

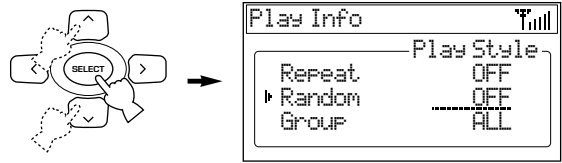

4. Use ^ / v to change the Random Playback parameter setting.

OFF: Random Playback disabled
ON: Random Playback enabled

5. Press SELECT to confirm your setting. The cursor returns to the left of the “Random” parameter.

6. Press <.

The display returns to the Play Info screen.

■ To alter the limits of Random Playback

1. Begin playback of a track (see pages 35 – 44).

The Play Info screen appears on the display.

2. Press >.

The Play Style screen appears on the display.

3. Use ^ / v to move the cursor to “Group” and press SELECT.

The cursor moves so that it is displayed under the “Group” parameter setting.



4. Use ^ / ∨ to change the Group playback parameter setting.

SINGLE: The MusicCAST client targets tracks in the currently selected group (for example, album or genre) for selection for random playback.

ALL: The MusicCAST client targets all items in the currently selected group (for example, album or genre) for playback. When all songs in the current group have been played back, playback advances to the next group.

To target an entire group for random playback, you should press PLAY from the Albums, Genres, Artists, or All songs menu.

5. Press SELECT to confirm your setting.

The cursor returns to the left of the “Group” parameter.

6. Press <.

The display returns to the Play Info screen.

Repeat Playback

When you utilize the Repeat Playback function, the MusicCAST repeats playback of the current song or group.

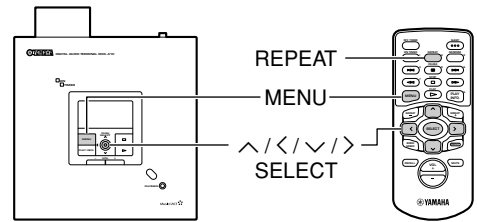

You can activate the Repeat Playback function by pressing REPEAT on the remote control. The MusicCAST client repeats playback in accordance with the current Repeat Playback setting parameter, accessible by following the procedure on this page.



To use the Repeat Playback function

1. Begin playback of a track (see pages 35 – 44).

The Play Info screen appears on the display.

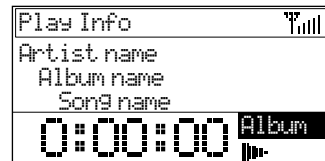

2. Press >.

The Play Style screen appears on the display.

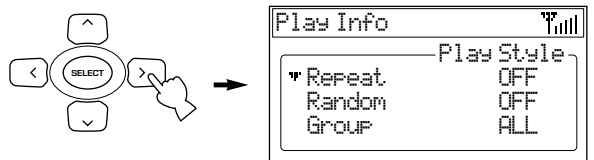

3. Use ^ / ∨ to move the cursor to “Repeat” and press SELECT.

The cursor appears under the “Repeat” parameter setting.

4. Use \wedge / \vee to change the Repeat Playback parameter setting.

- OFF: Repeat Playback disabled.
 SINGLE: The MusicCAST client repeats playback of the current group.
 ALL: The MusicCAST client repeats playback of all groups.

5. Press SELECT to confirm your setting.

The cursor returns to the left of the “Repeat” parameter.

6. Press \leftarrow .

The display returns to the Play Info screen.

Changing the time display on the Play Info screen

You can change the time display on the Play Info screen so that it displays either the time elapsed since playback of the current song started, or the time remaining to complete playback of the current song.

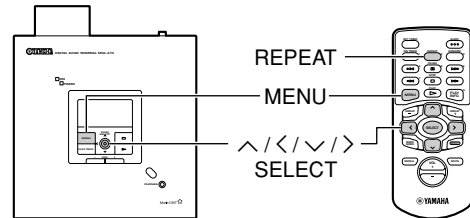

■ To alter the time display

1. Begin playback of a track (see pages 35 – 44).

The Play Info screen appears on the display.

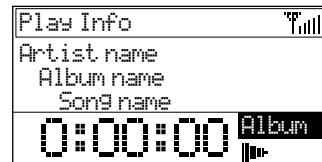

2. Press \rightarrow .

The Play Style screen appears on the display.

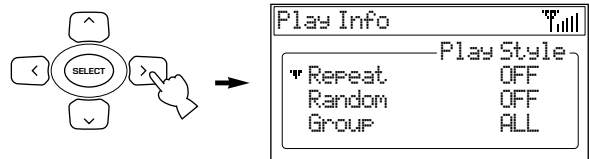

3. Use \wedge / \vee to move the cursor to “Time” and press SELECT.

The cursor moves so that it is displayed under the “Time” parameter setting.

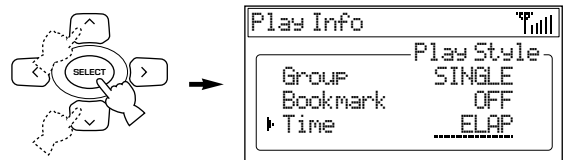

4. Use \wedge / \vee to change the display setting

ELAP: The timer displays the time elapsed since playback of the current song started

REM: The timer displays the time remaining to complete playback of the current song

5. Press SELECT to confirm your setting.

The cursor returns to the left of the “Time” parameter.

6. Press \leftarrow .

The display returns to the Play Info screen.

Listening to an external source connected to the MusicCAST server

You can listen to audio from an external source connected to the OPTICAL IN, COAXIAL IN, or ANALOG IN jacks on the MusicCAST server.

Notes

- The MusicCAST server can only distribute one source signal to MusicCAST clients. Changing the external source selection on any MusicCAST client changes the source external source selection for all MusicCAST clients connected to your MusicCAST server.
- The MusicCAST server cannot distribute signals from external components or AV receivers in PCM format. It distributes all such signals in MP3 format regardless of the PCM settings on the Playback system setting screen of the MusicCAST server (page 125, MCX-1000 owner’s manual).

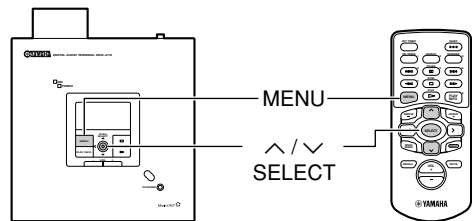
**1. Press and hold MENU for two seconds to return to the Top Menu screen.****2. Use \wedge / \vee to move the cursor to “Play” from the Top Menu and press SELECT.**

The Play Menu screen appears on the display.



3. Use \wedge / \vee to move the cursor to “External Inputs” and press SELECT.

The External Inputs menu appears on the display.

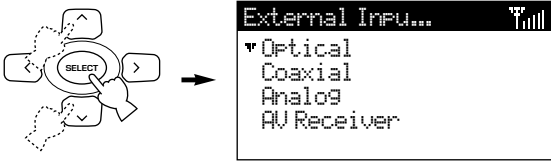

4. Use \wedge / \vee to select “Optical”, “Coaxial”, or “Analog”, depending on which input on the MusicCAST server the device you want to listen to is attached to. Press SELECT.

Note

- See pages 49, 50 if you wish to select “AV Receiver” from this menu.

5. The MusicCAST client outputs the audio signal from the external component connected to the MusicCAST server.

■ To return to playback from the MusicCAST server library

Repeat steps 1, 2, and 3, selecting any option other than “External Inputs” in step 3.

Listening to a radio station with your MusicCAST client

You can listen to radio stations with your MusicCAST client if you have a Yamaha receiver connected to your MusicCAST server with a cross type RS-232C cable. All of the preset stations on the receiver are available for selection.

Notes

- This function is only available if your MusicCAST server is connected to a correctly configured tuner-equipped YAMAHA AV receiver via a cross type RS-232C cable. See page 122 of the MCX-1000 owner’s manual for an explanation of how to configure the MusicCAST server and AV receiver, or page 133 of the same manual for an explanation of how to display a list of controllable YAMAHA AV receivers on screen.
- The MusicCAST server can only distribute one radio preset source signal to MusicCAST clients. Changing the radio preset source selection on any MusicCAST client changes the radio preset source external source selection for all MusicCAST clients connected to your MusicCAST server. The MusicCAST server automatically switches to external analog input.
- The MusicCAST server cannot distribute signals from external components or AV receivers in PCM format. It distributes all such signals in MP3 format regardless of the PCM settings on the Playback system setting screen of the MusicCAST server (page 125, MCX-1000 owner’s manual).

Using the procedure described below changes the Input setting on your AV receiver to tuner if it is connected to the MusicCAST server via its REC OUT jack.

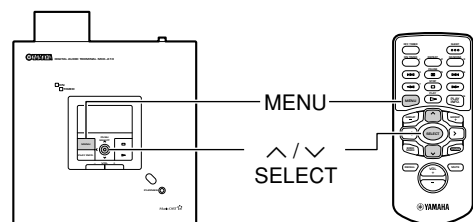

■ Selecting a radio station

Check that the MusicCAST server and connected receiver are both switched on before carrying out the following procedure:

- 1. Press and hold MENU for two seconds to return to the Top Menu screen.**



- 2. Use ^ / v to move the cursor to “Play” and press SELECT.**

The Play Menu screen appears on the display.



- 3. Use ^ / v to move the cursor to “External Inputs” and press SELECT.**

The External Inputs screen appears on the display.

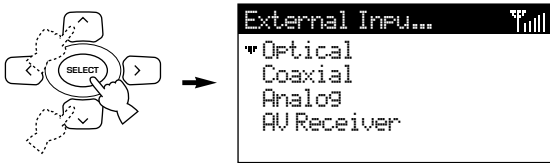

- 4. Use ^ / v to move the cursor to “AV Receiver” and press SELECT.**

The display lists the preset groups available on the receiver.

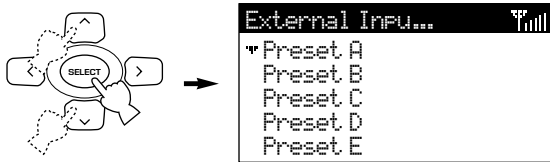

- 5. Use ^ / v to move the cursor to a preset group and press SELECT.**

The display lists the stations available within the preset group.

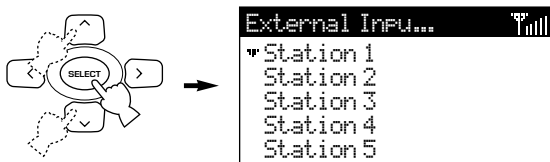

- 6. Use ^ / v to move the cursor to the station you want to access and press SELECT.**

The Play Info screen appears and playback of the selected radio station begins.

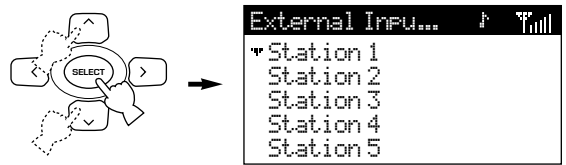

Listening to an external sound source

You can listen to audio from an external source connected to the AUX IN jack on your MusicCAST client.

Carry out the following procedure to listen to an external sound source using the MusicCAST client.

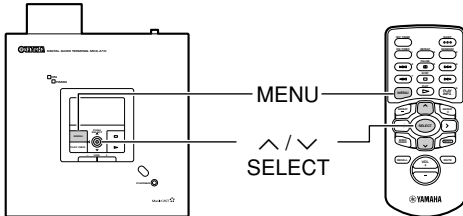

- 1. Press and hold MENU for two seconds to return to the Top Menu screen.**



- 2. Use ^ / v to move the cursor to “Input” and press SELECT.**

The Input screen appears on the display.

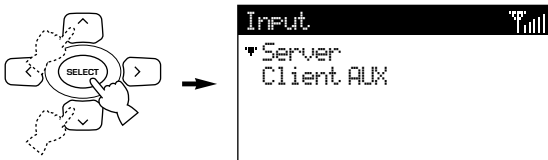

- 3. Use ^ / v to move the cursor to “Client AUX” and press SELECT.**

Playback of any song you are currently listening to stops.

- 4. The audio signal from the external source is output from the MusicCAST client speakers.**

Alternatively, selecting a song from the MusicCAST client menus returns this setting to “Server”.

■ To return to playback from the MusicCAST server library

Carry out the procedure as above, selecting “Server” instead of “Client AUX” in step 3.

Using the Bookmark function

The MusicCAST system can store a list of your favorite songs for easy access. You can access this list using the bookmark function. Each client on your MusicCAST network has one such list, which you can access but not alter from other clients. Each list can store up to 999 bookmarks, which you can copy to a playlist if you wish. All songs that have been bookmarked appear with a check sign displayed beside them in all of the song list menus.

Adding a song to the list of bookmarks

There are two methods you can use to add a song to your list of bookmarks.

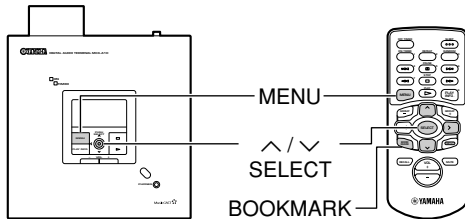

■ Adding a song using the Play Info screen

1. Follow through the steps described in the “Playback” section (see pages 35 – 44) to start playback of a song.

The Play Info screen appears on the display.

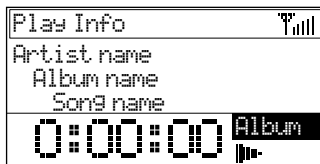

2. Press **BOOKMARK**.

A check sign appears beside the song name on the on screen display.



To remove the bookmark from the song, press **BOOKMARK** again.

■ Adding a song using the menu

1. Press and hold **MENU** for two seconds to return to the Top Menu screen.



2. Use **^/∨** to move the cursor to “Play” and press **SELECT**.

The Play Menu screen appears on the display.



3. Access the song list via the **Artists, Albums, Genres, or All Songs** menus as described on pages 35 – 44.



4. Use **^/∨** to move the cursor to the song you wish to add to the bookmark list.

5. Press **BOOKMARK**.

A check sign appears beside the song you have registered to the bookmark list.



Note

- Press **BOOKMARK** when the cursor is next to an album to bookmark the entire album. You cannot remove bookmarks in this manner. Remove bookmarks for songs individually.

Removing a song from the bookmark list

There are two methods you can use to remove a song from the list of bookmarks.

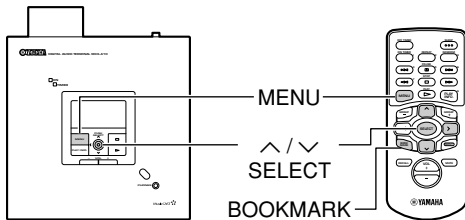

5. Press BOOKMARK.

The check sign displayed beside the bookmarked song disappears.



Note

- If the song was not previously bookmarked, this action assigns the song to a bookmark list.

■ Removing a song using the Menu

1. Press and hold MENU for two seconds to return to the Top Menu screen.



2. Use ^ / v to move the cursor to "Play" and press SELECT.

The Play Menu screen appears on the display.



3. Access the song list via the Artists, Albums, Genres, or All Songs menus as described on pages 35 – 44.

All songs currently bookmarked have a check symbol displayed beside them.



4. Use ^ / v to move the cursor to the song you wish to remove from the bookmark list.

Copying the bookmark list to a playlist

You can copy the contents of your MusicCAST client bookmark list to a playlist. This makes your client bookmark list readily available to all other clients on your MusicCAST network as well as to the MusicCAST server, and preserves the bookmark list so that it is not affected by any subsequent changes you make.

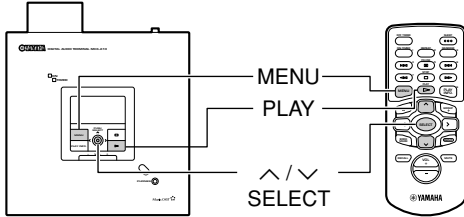

4. Press PLAY to create a playlist.

The MusicCAST client creates a new playlist in collection 1 on the MusicCAST server. The display returns to the Edit Bookmark screen.

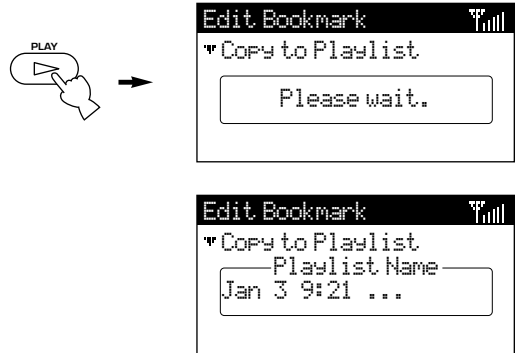

■ Copying the bookmark list

1. Press and hold MENU for two seconds to return to the Top Menu screen.



2. Use ^/∨ to move the cursor to “Edit Bookmark” and press SELECT.

The Edit Bookmark screen appears on the display.

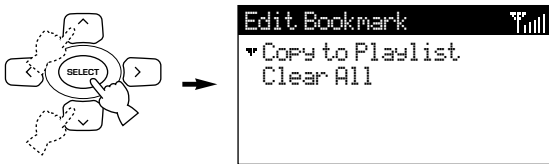

3. Use ^/∨ to move the cursor to “Copy to Playlist” and press SELECT.

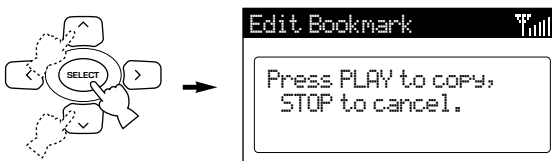

Erasing the bookmark list

To erase the bookmark list completely, carry out the following procedure:

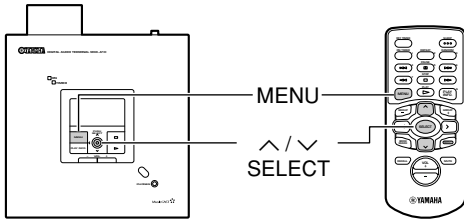

■ Erasing the bookmark list

1. Press and hold MENU for two seconds to return to the Top Menu screen.



2. Use ^ / v to move the cursor to “Edit Bookmark” and press SELECT.

The Edit Bookmark screen appears on the display.

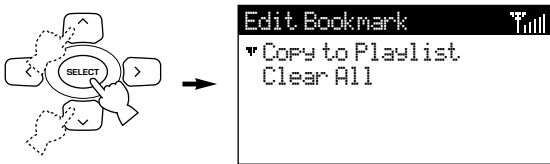

3. Use ^ / v to move the cursor to “Clear All” and press SELECT.

A configuration message appears on the display.

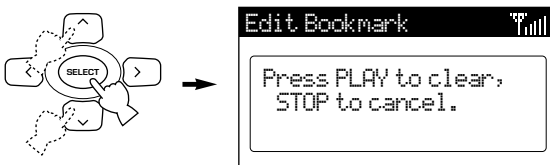

4. Press PLAY or STOP.

PLAY: Confirm the erase action and return to the Edit Bookmark menu.

STOP: Cancel the action and return to the Edit Bookmark menu.

MusicCAST settings

Default system settings

The following table illustrates the default settings for all of the parameters described in this section.

Setting menu	Parameter group	Parameter name	Parameter setting	
Setup	OFF Timer		OFF	
	ON Timer		OFF	
	Auto Play		OFF	
	Auto Level Control		OFF	
	Contrast		68 %	
	Network	Manual Setup – Mode		Auto
		Manual Setup – Server ID		SV-00000
		Manual Setup – DHCP		ON
		Manual Setup – IP Address		192.168.1.2
		Manual Setup – Subnet Mask		255.255.255.0
Manual Setup – ESS ID			MC	
Manual Setup – WEP key			(none)	
Input			SERVER	
Tone	Treble		±0dB	
	Bass		±0dB	
Volume level			-70dB	

Using the OFF Timer function

You can set the MusicCAST client to switch itself off after a set period of time, which you can also define. This function is called the OFF Timer. You can use the ON and OFF timers simultaneously.

■ Using the menu to set the OFF Timer function

Carry out the following procedure to set the OFF timer from the menu of your MusicCAST client.

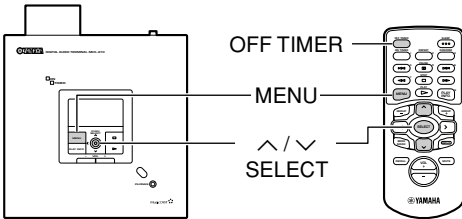

1. Press and hold MENU for two seconds to return to the Top Menu screen.



2. Use ^/\ to move the cursor to “Setup” and press SELECT.

The Setup screen appears on the display.

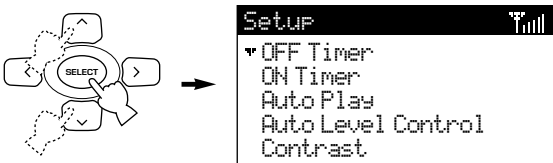

3. Use ^/\ to move the cursor to “OFF Timer” and press SELECT.

The OFF Timer screen appears on the display.

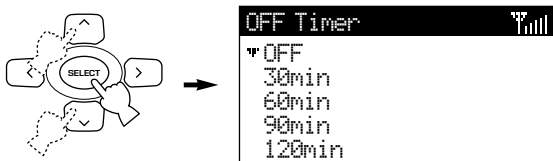

4. Use ^/\ to select the time (in minutes) for the MusicCAST to continue in the power-on mode before switching itself to the standby mode.

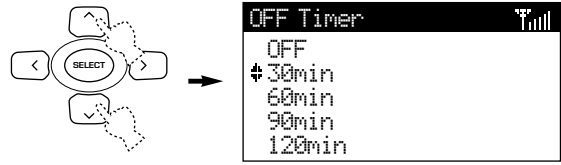

5. Press SELECT to confirm the setting.

The confirmation screen appears on the display.

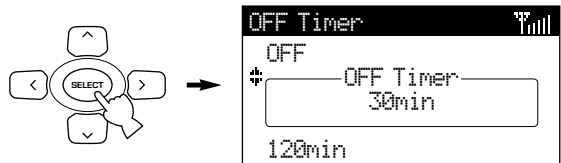

6. The display returns to the Setup screen after a small delay, and the TIMER indicator lights.

■ Using OFF TIMER on the remote control to set the OFF Timer

Carry out the following procedure to access the OFF Timer function from any screen.

1. Press OFF TIMER.

The OFF Timer screen appears on the display.



2. Press OFF TIMER repeatedly to cycle through the available settings.

The available OFF Timer settings are 30, 60, 90, 120 minutes, and OFF. Selecting any setting other than OFF activates the OFF timer function, and sets it to place the MusicCAST client in sleep mode 30 – 120 minutes from the time you activate it, depending on the setting you select.



3. The OFF Timer screen disappears after a small delay.

Using the ON Timer function

The MusicCAST client has a timer function that enables it to automatically switch on and begin playback at a time you specify, rather like an alarm clock. This is called the ON Timer function. You can use the ON timer and OFF Timer simultaneously.

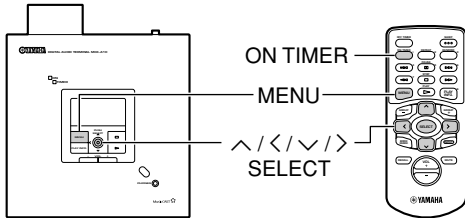

■ Setting the timer

Carry out the following procedure to set the MusicCAST client to power up at a specified time:

1. Press and hold MENU for two seconds to return to the Top Menu screen.



2. Use ^ / v to move the cursor to "Setup" and press SELECT.

The Setup screen appears on the display.

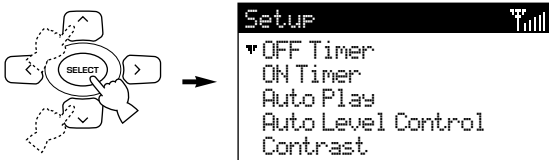

3. Use ^ / v to move the cursor to "ON Timer" and press SELECT.

The ON Timer screen appears on the display.

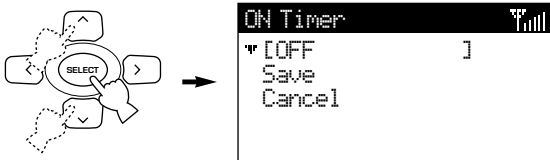

4. Press SELECT.

The cursor enters the ON Timer setting field.

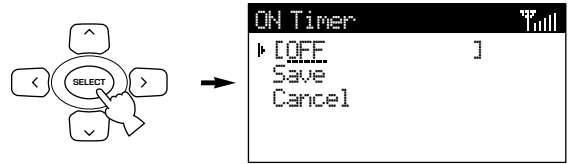

5. Use ^ / v to set the ON Timer setting to ON and press >.

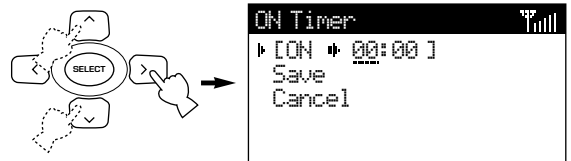

6. Enter the time you wish the MusicCAST client to switch on by pressing ^ / v to cycle through the displayed characters, and pressing < / > to move the cursor left and right.

7. Press SELECT to confirm the setting.

8. If you are satisfied with the settings you have made, move the cursor to "Save" and press SELECT.

The confirmation screen appears.

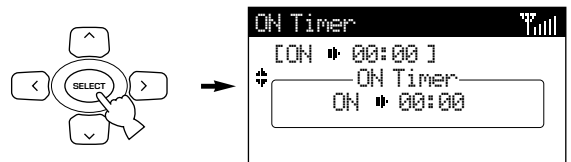

Alternatively, select "Cancel" to exit from this screen without saving and confirmation.

9. Use the method described on page 63 or the Off Timer function described on page 57 to place the MusicCAST client in Sleep mode.

The TIMER indicator lights.

■ Using the ON TIMER key to activate the ON Timer

Carry out the following procedure to activate the ON Timer function from any screen.

1. Press ON TIMER

The ON Timer screen appears on the display.

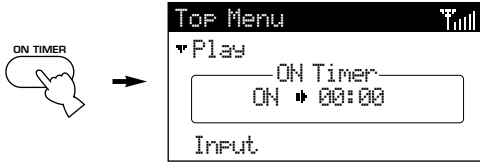

2. Press ON TIMER repeatedly to turn the ON Timer function on or off.

3. The ON Timer screen disappears after a small delay.

4. Use the method described on page 63 or the Off Timer function described on page 57 to place the MusicCAST client in Sleep mode.

The TIMER indicator lights.

Note

- Set the MusicCAST server to ON or LAN standby mode when using the ON Timer to start playback of music on a MusicCAST client.

Using the Auto Play function

You can set the MusicCAST client to automatically resume playback of the track it was playing at the time it was last placed in Sleep mode, when you return it to On mode.

Carry out the following procedure to configure your MusicCAST client to use Auto Play:

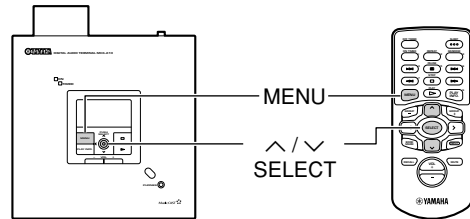

1. Press and hold MENU for two seconds to return to the Top Menu screen.



2. Use ^ / v to move the cursor to "Setup" and press SELECT.

The Setup screen appears on the display.

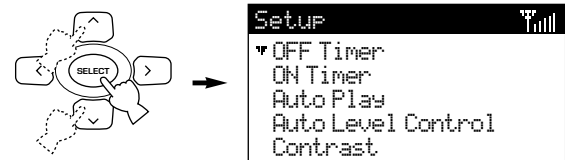

3. Use ^ / v to move the cursor to "Auto Play" and press SELECT.

The Auto Play screen appears on the display.

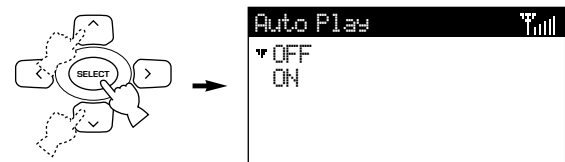

4. Use ^ / v to move the cursor to "ON" if you wish to use the Auto Play function, or "OFF" if you wish to switch it off.

5. Press SELECT.

The MusicCAST client is now configured to use your new settings for Auto Play.

Using the Auto Level Control function

The MusicCAST system allows you to store and listen to multiple different albums from different artists, without reference to the original sequence of songs on the album. Because some albums are recorded with different sound levels to others, you may encounter large differences between the sound levels of songs when playing back songs on your MusicCAST client.

The Auto Level Control function on the MusicCAST client automatically reduces or increases the base volume level to a theoretical average when it plays back songs, in order to eliminate any large differences in the volume at which the original songs were recorded.

Note

- The Auto Level Control Function may not always produce the best results if you are listening to different genres with very different base volume levels sequentially. If you notice that the quality of your listening experience decreases when you turn Auto Level Control on, please turn it off.

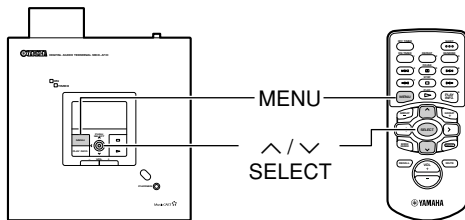

■ Turning Auto Level Control on or off

1. Press and hold MENU for two seconds to return to the Top Menu screen.



2. Use ^ / v to move the cursor to “Setup” and press SELECT.

The Setup screen appears on the display.

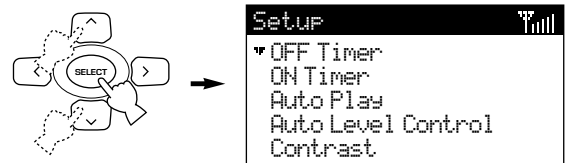

3. Use ^ / v to move the cursor to “Auto Level Control” and press SELECT.

The Auto Level Control screen appears on the display.

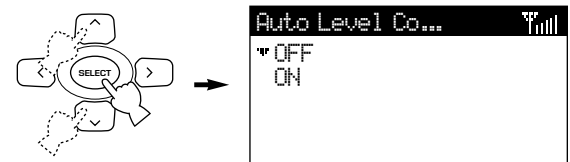

4. Use ^ / v to move the cursor to “ON” if you wish to use the Auto Level Control function, or “OFF” if you wish to switch it off.

5. Press SELECT.

The MusicCAST client is now configured to use your new settings for Auto Level Control.

Using the tone controls

The tone controls on the MusicCAST client allow you to alter the nature of the sound being output. You can change these settings to give a strong deep bass, or a lighter treble to the sound.

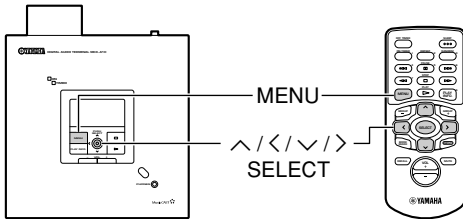

■ Altering the tone settings

1. Press and hold MENU for two seconds to return to the Top Menu screen.



2. Use ^ / v to move the cursor to “Tone” and press SELECT.

The Tone screen appears on the display.



3. Use ^ / v to move the cursor to the desired parameter and press SELECT.

Treble: Increase the setting of this parameter to increase the amount of treble in the sound output by the MusicCAST client.

Bass: Increase the setting of this parameter to increase the amount of bass in the sound output by the MusicCAST client.

The relevant menu appears on the display:

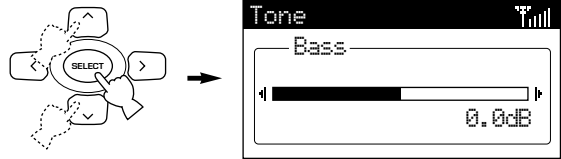
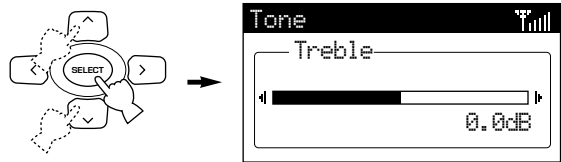

4. Use > or ^ to increase the value of the setting, and < or v to decrease the value of the setting.
5. Press SELECT or MENU to confirm the value you have set and return to the Tone screen.

Using the contrast controls

Depending on the location of the MusicCAST client, You may need to alter the contrast of the display for easier viewing. Darker settings make for easier viewing at night, while you may find it easier to view the display with brighter settings during the daytime.

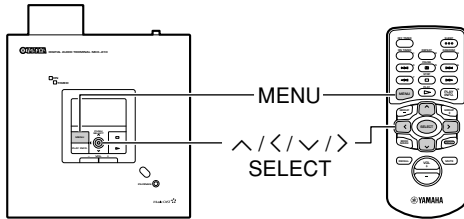

■ Altering the contrast settings

1. Press and hold MENU for two seconds to return to the Top Menu screen.



2. Use ^ / ∨ to move the cursor to “Setup” and press SELECT.

The Setup screen appears on the display.

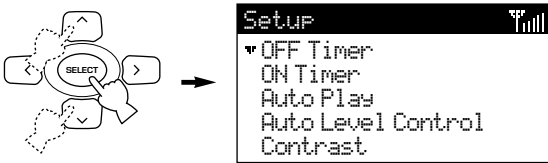

3. Use ^ / ∨ to move the cursor to the “Contrast” and press SELECT.

The Contrast screen appears on the display.

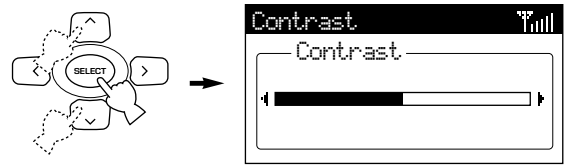

4. Use > or ^ to increase the value of the setting, and < or ∨ to decrease the value of the setting.

5. Press SELECT or MENU to confirm the value you have set and return to the Setup screen.

Using the Sleep function

You can set your MusicCAST client in Sleep mode when you are not using it. Power consumption is reduced in Sleep mode, but the MusicCAST client still consumes a small amount of power to keep the display and the remote control signal receiver in operation.

You can place the unit in sleep mode by carrying out the procedure below:

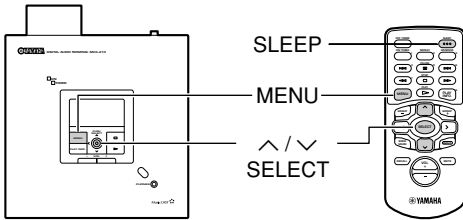

■ Switching the unit to sleep mode

1. Press and hold MENU for two seconds to return to the Top Menu screen.



2. Use ^/∨ to move the cursor to “Sleep” and press SELECT.

The Sleep prompt appears on the display.

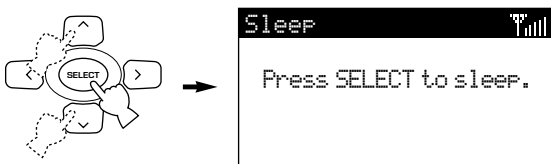

3. Press SELECT.

The MusicCAST client switches to sleep mode, and the current time appears on the display.

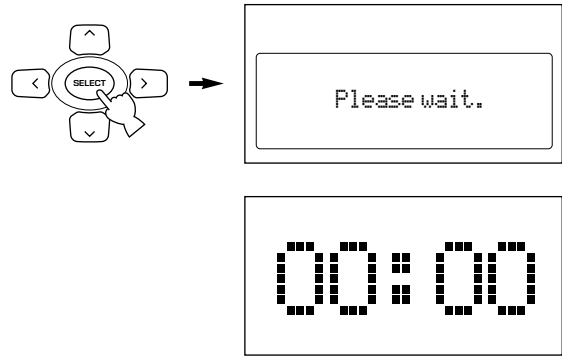

You can also switch the unit to sleep mode by pressing SLEEP on the remote control. The time does not display correctly if the MusicCAST client is not able to establish a good connection with the MusicCAST server. If the time displayed is not correct, alter the date and time settings on the MusicCAST server to display them correctly (See page 117 in the MCX-1000 owner’s manual for an explanation of how to do this).

■ Turning the MusicCAST client on again

Press SLEEP on the remote control or SELECT on the MusicCAST client.

The MusicCAST client turns on.

Note

- The MusicCAST client automatically places itself in sleep mode if you do not use it for 30 minutes.

Displaying System Information on the MusicCAST client

You can check the version of the system installed in your MusicCAST client.

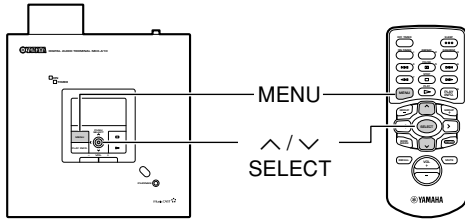

- Use \wedge / \vee to move the cursor to “Information” and press SELECT.

The Information screen appears on the display.



■ Accessing the System Information screen

- Press and hold MENU for two seconds to return to the Top Menu screen.



- Use \wedge / \vee to move the cursor to “Setup” and press SELECT.

The Setup screen appears on the display.

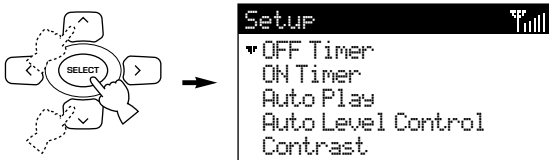

- Use \wedge / \vee to move the cursor to “System” and press SELECT.

The System screen appears on the display.

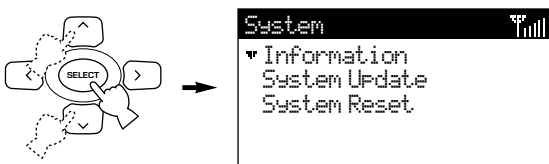

Updating the MusicCAST client firmware

At times Yamaha releases updates to the firmware in either or both the MusicCAST client and server. These updates are generally aimed at improving the experience of using your MusicCAST equipment. Follow the instructions provided with the update carefully. Do not use the update procedure unless specifically instructed to do so.

The procedure for updating the firmware is as follows:

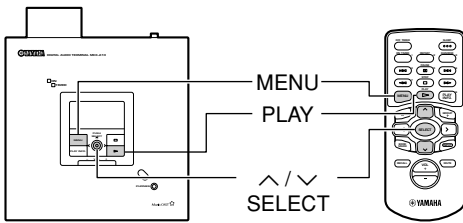

1. Place the update CD in the disc tray in your MusicCAST server.
2. Update the firmware on your MusicCAST server if necessary (see page 128 of the MCX-1000 owner's manual).
3. Press and hold MENU for two seconds to return to the Top Menu screen.



4. Use ^ / ▽ to move the cursor to "Setup" and press SELECT.

The Setup screen appears on the display.

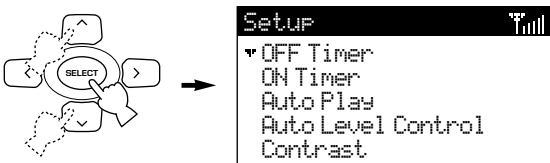

5. Use ^ / ▽ to move the cursor to "System" and press SELECT.

The System screen appears on the display.

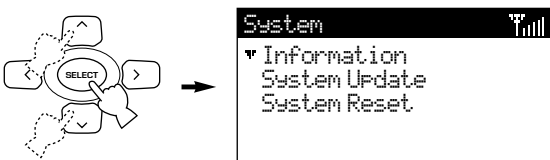

6. Use ^ / ▽ to move the cursor to "System Update" and press SELECT.

The System Update prompt appears on the display.

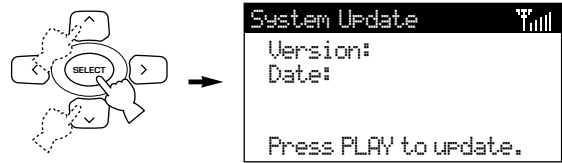

7. Press PLAY to begin the update process.

The following screens appear in order:



8. The MusicCAST automatically switches itself off and then on again.

The update process is now complete. Carry out the procedure described on page 64 to check the version of the firmware.

Resetting the MusicCAST client to default settings

At times it may be convenient to return your MusicCAST client to the default state it was in when you first purchased it. You may wish to do this in cases such as the following:

- When your MusicCAST client appears to be functioning incorrectly for no apparent reason, and reference to the troubleshooting section (page 69) is of no assistance.
- When you have made multiple mistakes in setting the parameters on your MusicCAST client and wish to start again.
- When you wish to reset the MusicCAST completely for use in a different MusicCAST network.

Warning

- Resetting the MusicCAST client to its default settings will not reverse any updates to the MusicCAST software that you have made, or erase any data stored in your MusicCAST network. It resets all settable parameters to their server settings, so you need to set them to suit your requirements after performing the reset procedure. Note that in resetting all the parameters, the MusicCAST client also resets its network parameters, and disconnects itself from your MusicCAST network.

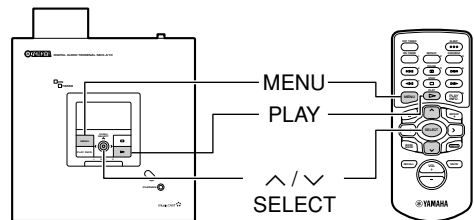

Resetting your MusicCAST client

1. Press and hold MENU for two seconds to return to the Top Menu screen.



2. Use \wedge / \vee to move the cursor to “Setup” and press SELECT.

The Setup screen appears on the display.

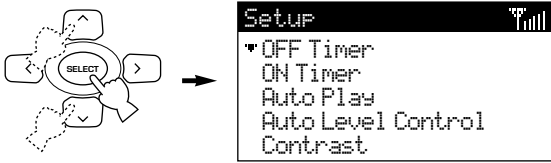

3. Use \wedge / \vee to move the cursor to “System” and press SELECT.

The System screen appears on the display.

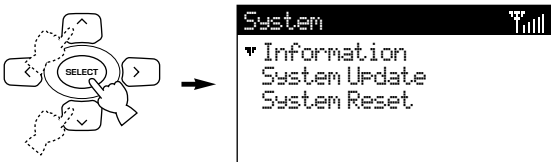

4. Use \wedge / \vee to move the cursor to “System Reset” and press SELECT.

The System Reset prompt appears on the display.

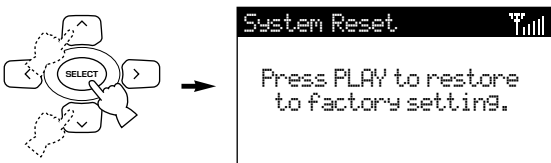

5. Press PLAY to begin the resetting process.

6. The MusicCAST automatically switches itself off and then on again.

The resetting process is now complete.

Displaying Network Status Information on the MusicCAST client

Your MusicCAST client depends on its network connection to obtain data from the MusicCAST server. The Network Status screen provides you with information on the quality of the network connection your MusicCAST is currently using.

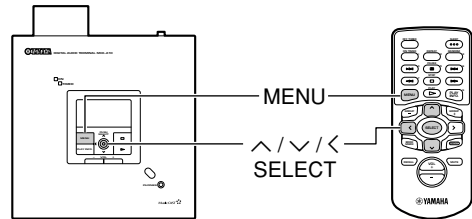

■ Accessing the Network Status screen

1. Press and hold MENU for two seconds to return to the Top Menu screen.



2. Use \wedge / \vee to move the cursor to “Setup” and press SELECT.

The Setup screen appears on the display.

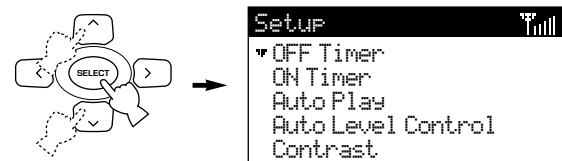

3. Use \wedge / \vee to move the cursor to “Network” and press SELECT.

The Network screen appears on the display.

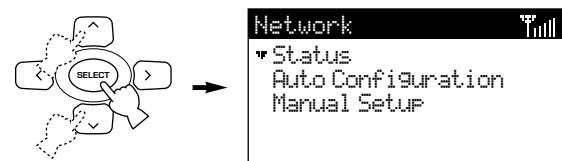

4. Use \wedge / \vee to move the cursor to “Status” and press SELECT.

The Status screen appears on the display.

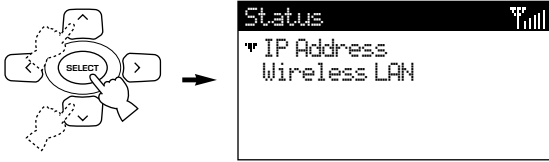

5. Use \wedge / \vee to select the item you want to display.

Select IP Address to display the following information



- ID:** The unique ID your MusicCAST client uses for network configuration (see pages 26, 27).
- IP:** The IP address your MusicCAST client is using.
- Msk:** The subnet mask your MusicCAST client is operating under.
- MAC:** The MAC address of your MusicCAST client. The MAC address is the unique identification code your MusicCAST client uses in the MusicCAST network.

Select Wireless LAN to display the following information:

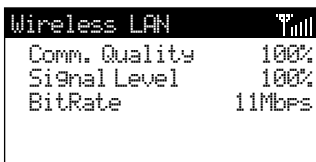

- Comm. Quality:** The quality of the network signal your MusicCAST client is receiving.
- Signal Level:** The strength of the signal your MusicCAST client is receiving.
- BitRate:** The speed at which your MusicCAST client is receiving data over the network connection, measured in megabits per second.

6. Press \leftarrow to return to the Status screen.

Troubleshooting

Refer to the chart below when this unit does not function properly. If the problem you are experiencing is not listed below or if the instruction below does not help, set this unit to the standby mode, disconnect the power cord, and contact the nearest authorized YAMAHA dealer or service center.

Problem	Cause	Remedy	Refer to page
Auto Configuration does not appear to work correctly.	The network is not configured correctly.	Check the network settings of the MusicCAST client and MusicCAST server.	21 – 34
	The network signal is weak (for wireless network connections only).	Try changing the network channel or the location of the MusicCAST client, or alternatively changing to a wired network connection.	21 – 34
	Either the MusicCAST server or the MusicCAST client is not set to Auto Configuration mode.	Check the configuration procedure and try again.	21 – 34
	The MusicCAST server is storing songs or recording.	Stop recording and start the Auto Configuration process again.	MCX-1000 owner's manual, page 21
The MusicCAST client does not output any sound.	The volume setting of the MusicCAST client is low.	Increase the volume setting.	10, 12, 13
	The MusicCAST client is not correctly connected to speakers.	Check the connections between the MusicCAST client and the speakers.	11, 20
You cannot start playback on the MusicCAST client.	Auto Configuration is not complete.	Run the Auto Configuration process.	26, 27
	The network is not configured correctly.	Check the network settings of the MusicCAST client and MusicCAST server.	21 – 34
	The MusicCAST server is turned off.	Turn the MusicCAST server on.	20
	The hard disk drive in the MusicCAST server does not contain any songs that have been completely encoded to MP3 format.	Wait until the MusicCAST server completes encoding songs to MP3. Register songs stored from external components to the library, or wait for the MP3 encoding process to complete.	MCX-1000 owner's manual, page 121
	When the MusicCAST server is set to distribute MP3 files to your MusicCAST client, the MusicCAST client displays a “*” beside songs which the MusicCAST server has not converted to MP3 format.	The “*” displayed beside PCM-only songs disappears when encoding is complete.	MCX-1000 owner's manual, page 121
	The network signal is weak (for wireless network connections only).	Try changing the network channel or the location of the MusicCAST client, or alternatively changing to a wired network connection.	21 – 34
	The network signal is weak (for wireless network connections only).	Try changing the network channel or the location of the MusicCAST client, or alternatively changing to a wired network connection.	21 – 34
Playback from the MusicCAST client skips.	The network is extremely congested (for wired network connections only).	Place your MusicCAST clients under an independent subnet mask, or upgrade your network hardware.	21 – 34

Problem	Cause	Remedy	Refer to page
The MusicCAST client does not play back some songs displayed in the song selection menus.	You have not registered songs recorded from an external component to the library.	Wait until the MusicCAST server completes encoding songs to MP3.	MCX-1000 owner's manual, page 121
You cannot select an external input from the MusicCAST client.	The MusicCAST server is recording from an external source.	Wait until the MusicCAST server finishes recording.	MCX-1000 owner's manual, page 21
Playback from an external component cuts off for no reason.	The MusicCAST server is receiving signal change requests from another source.	Stop the signal request changes from other MusicCAST clients.	48
None of the controls other than the volume control have any effect on the MusicCAST client.	The MusicCAST server is locking the MusicCAST client.	Use the MusicCAST server to remove the lock.	MCX-1000 owner's manual, page 92
Starting playback on the MusicCAST client produces interference noise on nearby radios.	The MusicCAST client and the radio are too close to each other.	Place the MusicCAST client and the radio at least one meter apart.	23
The MusicCAST client does not output any sound when you search forward or backward through a track.	This is normal when searching through a track.	Continue to use this function in the same manner.	—
The message "Error: Amp Protection Active" appears on the on-screen display of MusicCAST client.	The cables are not connected correctly.	Connect the cables correctly.	11
	You are using low-impedance speakers.	Please use speakers with an impedance of at least 4 ohms.	—
The side panel cover does not reattach correctly.	You are using audio or video cables other than those supplied to connect the MusicCAST client to an amplifier or TV/monitor.	The panel cannot close unless you use the audio or video cable with the L shaped jacks supplied with the MusicCAST client.	—
	The rubber covering of the LAN cable is blocking the panel cover.	Remove the rubber covering from the LAN cable.	—
Playback on the MusicCAST client skips or pauses.	You are using close to the maximum number of MusicCAST clients and simultaneously playing, storing, or editing on the MusicCAST server.	Reduce the number of MusicCAST clients to which the MusicCAST server is distributing music, or stop any operation you are performing on the MusicCAST server.	23, 24
There is a significant pause between playback of songs on the MusicCAST client.	This is normal when listening with the MusicCAST client.		—

Problem	Cause	Remedy	Refer to page
<p>You cannot access the MusicCAST preset tuner.</p>	<p>The ANALOG REC LEVEL on the front panel of the MusicCAST server is set too low.</p>	<p>Increase the ANALOG REC LEVEL.</p>	<p>MCX-1000 owner's manual, page 29</p>
	<p>The MusicCAST server AV receiver parameters are configured incorrectly.</p>	<p>Configure the AV receiver parameters correctly.</p>	<p>MCX-1000 owner's manual, page 122</p>
	<p>The AV receiver connected to the MusicCAST server is not turned on.</p>	<p>Turn the AV receiver on.</p>	<p>—</p>
	<p>The AV receiver is not correctly connected to the MusicCAST server.</p>	<p>Correctly connect the AV receiver to the MusicCAST server.</p>	<p>MCX-1000 owner's manual, page 122</p>
	<p>The AV receiver is not receiving a strong radio signal.</p>	<p>Refer to the owner's manual of your AV receiver.</p>	<p>—</p>
<p>Playback cuts off or switches to another input when listening to a tuner preset on the MusicCAST client.</p>	<p>Another MusicCAST component is changing the tuner preset or external input on the MusicCAST server.</p>	<p>Stop the other MusicCAST component from changing input sources.</p>	<p>48 – 51</p>
<p>Auto Configuration does not appear to work correctly.</p>	<p>There is more than one DHCP server operation in the network trying to use the same IP addresses.</p>	<p>Deactivate the MusicCAST server DHCP function.</p>	<p>MCX-1000 owner's manual page 110</p>

Terms used in this manual

This manual uses a number of terms that, though not specific to the MusicCAST system, are not in general everyday use. In addition, some terms are used in a slightly unusual context. These words are listed alphabetically and in context below, along with an explanation of their meaning.

Playback

Album

A collection of songs in the MusicCAST database assigned to a particular artist, and given a name. Each album is assigned to an artist. By default, each CD you store in the MusicCAST server is stored as an Album.

Artist

The item in the MusicCAST database to which albums are assigned. The artist of any CD you store in the MusicCAST is stored as the artist to the corresponding album (see album above).

Bookmark list

A list of songs you have designated for easy retrieval using a MusicCAST client.

Genre

The music type to which the albums stored in the MusicCAST server are assigned. Examples include Jazz, Rock, and Classical.

Group

The category which you are operating your MusicCAST component in. For example, if you playback an album without selecting a song, then you are operating within the “album” category. If you playback a genre without selecting a song, you are operating within the “genre” category.

Playlist

A list of songs you designate using the MusicCAST server for playback in a given sequence.

Song

A single continuous track, equivalent to a single track from a CD, cassette, or other source, stored on the MusicCAST server.

Recording

MP3 Format

A data format used to store music on the Hard Disk Drive in the MusicCAST server. MP3 files take roughly one tenth of the space that PCM files need

to store the same song. However, sound quality is not as good as that of PCM files, and the MusicCAST server cannot record MP3 files to a CD-R.

PCM format

A data format used to store music on the hard disk drive in the MusicCAST server. PCM files provide CD-quality audio playback but require a lot of space on the hard disk drive.

Network connections

Connections

The links between the components in your MusicCAST system which allows them to exchange information. MusicCAST components can make both wired and wireless connections.

DHCP

A system of automatically assigning IP addresses to components in a LAN. A server component running a DHCP service assigns an IP address to components when they are switched on.

ESS ID

The ID of the channel that your MusicCAST system uses to transmit data when using wireless connections.

IP address

Four 3 digit numbers that together make up a unique identity number used by a component connected to a network.

LAN cable

A cable for connecting two components on a Local Area Network (LAN).

Network

A network is a collection of electronic components which share data and resources with one another.

Subnet mask

A number identifying the group within a network to which a particular component belongs.

TCP/IP

An abbreviation of Transmission Control Protocol/Internet Protocol, a system of coding information that allows it to be shared efficiently on a network.

WEP

An abbreviation of Wired Equivalent Privacy. This system encrypts data transferred between the components on a wireless network. Components with the same encryption key can share data with each other, but components without this key cannot.

Wireless LAN

A network utilizing weak radio signals to share data between components.

Wired LAN

A network utilizing LAN cables to share data between components.

Hardware

CD

An abbreviation of Compact Disc. A small plastic disc 12 cm (5") in diameter encoded with pre-stored data.

CD-R

An abbreviation of Compact Disc Recordable. A small plastic disc identical to a CD in appearance, onto which a device such as the MusicCAST server can record data. The MusicCAST server can only use Audio type CD-R media.

CD-RW

An abbreviation of Compact Disc Re-writable.

Controller

The device on the front panel of the MusicCAST server and MusicCAST client used for entering data and navigating through the menus contained in these two components.

Front panel

The panel on the MusicCAST server and MusicCAST client on which operational data is displayed.

Hard disk drive

The component within your MusicCAST server that allows it to store the audio material from your CDs as data. Hard disk drive capacity is expressed in megabytes, with a larger number denoting more

storage capacity.

Hard disk

See "Hard disk drive"

MusicCAST client

The component in the MusicCAST system that allows you to access songs stored in the MusicCAST server for playback at a distance. Up to seven MusicCAST clients can access the MusicCAST server at once.

MusicCAST server

The component in the MusicCAST system that you use to store and playback songs from CD. Other components in the MusicCAST system obtain song data from the MusicCAST server.

On-screen display

The LCD display on the MusicCAST client or the display output to a TV or monitor connected to the MusicCAST server.

Remote control

A handheld device for operating your MusicCAST components at a distance.

Software

Menu

A display consisting of a multiple choice style list of options that you can choose from. Menus are displayed on the on-screen display of the MusicCAST client and server.

■ Audio performance

Frequency response (EIAJ)
..... 20 Hz to 20 kHz, ± 0.5 dB

Signal to noise ratio (EIAJ) 100 dB or more

Dynamic Range (EIAJ) 90 dB or more

Total harmonic distortion + noise (EIAJ)
..... 0.008 % or less

■ Input

AUX IN jack
Input sensitivity 300 mVrms

■ Output

LINEOUT L/R
Output level 2 Vrms

S. WOOFER jack
Output level (volume max.) 1 Vrms

PHONES jack
Output level (phones level max., 150 Ω , -20dB)
..... 650 mV

SPEAKER OUT terminals
Maximum power (EIAJ, 4 Ω , 1kHz, 10 %THD)
..... 17 W + 17 W

■ General

Playback data format MP3, linear PCM

Power supply AC 100 to 240 V, 50/60 Hz

Power consumption 40 W

Standby power consumption
[U.S.A and Canada models] 0.7 W
[Europe and Australia models] 1.1 W

Operating temperature +5 to 35°C

Dimensions (W x H x D)
.. 210 x 244.5 x 79 mm (8-5/16" x 9-1/4" x 3-1/8")

Weight (without AC adaptor) 2 kg (4 lbs 6 oz)

Index

- A**
 - alarm clock 58
 - Album 35, 38
 - Artist 35, 37
 - Auto Configuration 22, 25, 26, 28
 - Auto Play function 59
 - AUX IN 11
 - AV receiver 48, 49
- B**
 - Bitrate 68
 - Bookmark 13, 36, 43, 52
 - Bookmarks 43, 52
- C**
 - collection 41
 - Comm. quality 68
 - Contrast 62
- D**
 - database 40
 - DHCP 28, 30
- E**
 - ESS ID 30
- F**
 - firmware 65
- G**
 - Genre 39
 - Graphical user interface 15
 - Group 36
- H**
 - Hub 21, 24
- I**
 - IP Address 22, 32
- L**
 - LAN 22, 23, 24
 - library 49
 - Lock 15
 - Lock icon 15
- M**
 - MP3 35
 - MusicCAST client 10, 14
 - MusicCAST server 20, 25
- N**
 - network 21
 - network addresses 22
 - network configuration 68
 - Network menu 28, 31
 - Network status 67
- O**
 - OFF Timer 12, 57
 - On-screen display 12, 33, 34, 52
 - ON Timer 12, 58, 59
- P**
 - PCM 35
 - Play info screen 16, 36
 - playback group 12, 13, 35, 45
 - playlist 35, 41, 52, 54
- R**
 - radio station 49
 - Random 16
 - Random play 16
 - Repeat 12, 46
 - Repeat playback 12, 35, 46
 - Resetting 66
 - Router 21, 24
 - RS-232C 48
- S**
 - Server ID 22, 28, 32
 - Signal level 68
 - Sleep 13, 14, 63
 - Song 35, 40
 - Standby 10, 14, 57
 - Subnet mask 28, 33
 - System information 64
- T**
 - Time 14, 35
 - Timer function 10, 12, 57
 - Top menu 14, 15
- U**
 - Updating 65
- W**
 - WEP key 28, 33
 - wired connection 24, 25, 29
 - wireless connection 23, 25, 29, 30
 - wireless lan 22, 68



This document is printed on chlorine free (ECF) paper with soy ink.

YAMAHA ELECTRONICS CORPORATION, USA 6660 ORANGETHORPE AVE., BUENA PARK, CALIF. 90620, U.S.A.
YAMAHA CANADA MUSIC LTD. 135 MILNER AVE., SCARBOROUGH, ONTARIO M1S 3R1, CANADA
YAMAHA ELECTRONIK EUROPA G.m.b.H. SIEMENSSTR. 22-34, 25462 RELLINGEN BEI HAMBURG, F.R. OF GERMANY
YAMAHA ELECTRONIQUE FRANCE S.A. RUE AMBROISE CROIZAT BP70 CROISSY-BEAUBOURG 77312 MARNE-LA-VALLEE CEDEX02, FRANCE
YAMAHA ELECTRONICS (UK) LTD. YAMAHA HOUSE, 200 RICKMANSWORTH ROAD WATFORD, HERTS WD18 7GQ, ENGLAND
YAMAHA SCANDINAVIA A.B. J A WETTERGRENS GATA 1, BOX 30053, 400 43 VÄSTRA FRÖLUNDA, SWEDEN
YAMAHA MUSIC AUSTRALIA PTY, LTD. 17-33 MARKET ST., SOUTH MELBOURNE, 3205 VIC., AUSTRALIA

YAMAHA CORPORATION
Printed in Japan **UP** WB18780-1