**OWNER'S
MANUAL**

**BASS
AMPLIFIER**

B100-112III

B100-115III

The Yamaha B100-112III/115III bass amplifier is the culmination of many years of research, and represents the finest in modern design and manufacturing techniques. This is a precision-built amplifier upon which the professional musician can depend for maximum reliability under the harshest of "real world" conditions. It provides the utmost in tonal and functional flexibility, designed to meet the wide-ranging demands of contemporary musical expression. This Owner's Manual should be carefully studied in order to fully realize the potential of your B100-112III/115III, and to keep it in the best condition for many years of trouble-free use.

— CAUTION —

- When connecting the electric bass guitar and the amplifier, make sure to plug in the bass guitar before plugging in the amplifier. Plugging in the amplifier first may cause damage to the speaker.
- Be sure to turn VOLUME of the amplifier counterclockwise to its minimum position when plugging or unplugging the connecting cord and turning the power supply ON and OFF.
- Always handle the amplifier with care. Rough handling or dropping it may cause poor performance.
- Check for correct voltage before connecting the power cord to your local AC outlet.
- Disconnect the power cord from the AC outlet whenever there is a thunderstorm in order to prevent accidents resulting from lightning.

● SPECIFICATIONS

	B100-112III	B100-115III
OUTPUT POWER	100W RMS @10% THD into 8Ω	
SPEAKER	JA3113A 12"(30cm) x 1	JA3812 15"(38cm) x 1
INPUT LEVEL/ IMPEDANCE		
INPUT	-20dB (77.5mV)/1MΩ	
POWER AMP INPUT	-10dB (245mV)/20kΩ	
OUTPUT LEVEL		
SPEAKER (8Ω)	100W	
PRE AMP OUT (10kΩ)	-10dB (245mV)	
HPF OUTPUT (10kΩ)	-10dB (245mV)	
LPF OUTPUT (10kΩ)	-10dB (245mV)	
BAL. OUTPUT (600Ω)	+4dB (1.23V)	
PHONES (8Ω)	-11dB (218mV)	
GAIN		
INPUT → SPEAKER OUT	64dB	
INPUT → PRE AMP OUT	20dB	
INPUT → BAL. OUTPUT	50dB	
POWER AMP IN → SPEAKER OUT	41dB	
NOISE*		
All Volumes at Min.	-55dB	
VOLUME, TREBLE, MIDDLE, BASS at Max.	-45dB	
PARAMETRIC EQUALIZER LEVEL	±15dB	
Q	0.35 ~ 3.0	
FREQUENCY	50Hz ~ 2.5kHz	
PRESET LEVEL	±10dB	
POWER REQUIREMENT		
Canadian model	120V AC60Hz	
General model	110/130/220/240V AC50/60Hz	
POWER CONSUMPTION		
Canadian model	180W	
General model	250W	
DIMENSIONS** (W x H x D)	568mmx665mmx357mm (22-3/8"x26-1/8"x14")	568mmx785mmx357mm (22-3/8"x30-1/8"x14")
WEIGHT***	35.2kg (77.6 lbs)	42.8kg (94.4 lbs)
STANDARD ACCESSORY	FOOT SW	

* Measured with a 6dB/oct. filter @12.7kHz

** Height include Castors.

*** Weight include Castors.

• 0dB is referenced to 0.775V RMS.

• Specifications are subject to change without notice.

● LOUDSPEAKER SPECIFICATIONS

	B100-112III	B100-115III
CONE DIAMETER	12" (30cm)	15" (38cm)
VOICE COIL DIAMETER (mm)	66φ	66φ
MAGNET WEIGHT (kg)	Ferrite 3.5	Ferrite 6.1
FREQUENCY RANGE (Hz)	60 ~ 6.5k	50 ~ 5.5k
SOUND PRESSURE LEVEL 1m/W (dB)	99	98.5
RATED INPUT* (W)	120	120
NOMINAL IMPEDANCE (Ω)	8	8
f₀ (Hz)	65	39

* Continuous RMS power rating.

FRONT PANEL

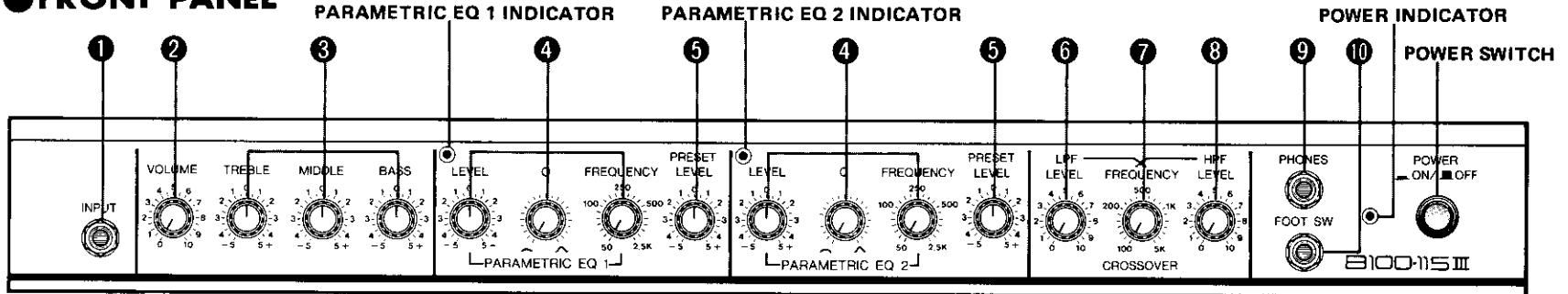

B100-115III

1 INPUT jack

Standard 1/4" mono phone jack. The instrument is plugged in here.

2 VOLUME control

This knob controls the output power. Turning it clockwise increases the volume. When connecting or disconnecting a bass, always turn the volume fully counterclockwise to minimum.

3 ACTIVE TONE CONTROLS/FLAT AT CENTER (12 O'CLOCK) POSITION

• TREBLE

Turn clockwise to emphasize the high-frequency range, counterclockwise to de-emphasize the high frequencies.

• MIDDLE

Turn clockwise to emphasize the mid-frequency range, counterclockwise to de-emphasize the midrange frequencies.

• BASS

Turn clockwise to emphasize the low-frequency range, counterclockwise to de-emphasize the bass frequencies.

4 PARAMETRIC EQUALIZER

Two complete parametric equalizers are provided.

These sections incorporate three controls—LEVEL, Q and FREQUENCY which permit exceptionally fine control over the amplifiers response characteristics. The section makes it possible to approximate the general tonal character of practically any bass sound. With the remote footswitch, the PARAMETRIC EQ's may be preset and "punched in" when needed for altering the sound.

• LEVEL

Turning this knob clockwise towards "+" causes a peak at the frequency selected by the FREQUENCY knob, emphasizing this frequency region. Turning the knob counter-clockwise causes a dip, de-emphasizing the selected frequency region. When this knob is at center position, no effect is obtained, regardless of the positions of the Q and FREQUENCY knobs.

The set equalizing point is centered with the FREQUENCY knob, and boost or cut can be obtained within a maximum range of +/- 15dB.

• Q

This knob adjusts the width of the frequency band being equalized. If turned clockwise toward (\wedge), a sharper characteristic is obtained, narrowing the influenced sound range.

● FREQUENCY

This knob adjusts the frequency to be influenced. The markings show the center frequency of the peak or dip.

The center frequency can be continuously set between 50Hz and 2.5kHz.

⑤ PRESET LEVEL

The preset level controls the overall volume of the equalized sound. It may be used to achieve unity gain or for boost, if required.

⑥ LPF LEVEL

This control sets the output level to the LPF OUTPUT. The level of all frequencies below the crossover frequency will be affected by this control.

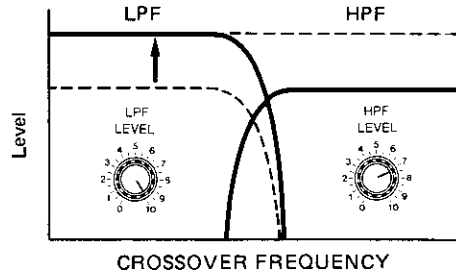

⑦ CROSSOVER FREQUENCY

This control sets the crossover frequency (cut-off frequency) of the LPF output and HPF output. The range can be set from 100Hz to 5kHz.

The balance should be adjusted so that an accurate balance between high and low frequency is obtained.

⑧ HPF LEVEL

This control sets the output level to the HPF OUTPUT.

The level of all frequencies above the crossover frequency will be affected by this control.

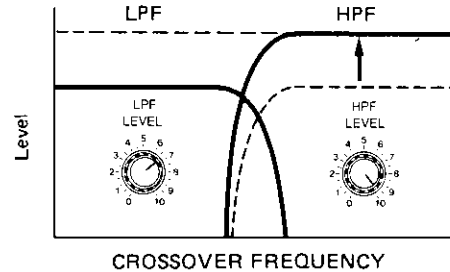

BI-AMP SYSTEM

This unit has a built-in crossover, and the output signal is split into high frequencies and low frequencies. Separate power amps (or channels of a stereo amp) process the highs and lows apart from one another. It allows the power amps to run or efficiently resulting in greater SPL's and clarity.

A system set up in this way is referred to as a bi-amp system.

Where a bi-amp system is not set up (i.e. where there is no connection between the LPF OUTPUT and the HPF OUTPUT), the LPF LEVEL, CROSSOVER FREQUENCY, and HPF LEVEL knobs have no effect.

⑨ PHONES jack

A pair of low-impedance mono or stereo headphones can be plugged in here for tuning or private practice. For private listening, it is necessary to unplug the speaker from the rear panel. In this case, the PRE AMP OUT is still usable when listening through headphone.

⑩ FOOT SW

The foot switch, which is provided, is connected here. When the foot switch is used, the parametric equalizers can be turned ON and OFF while playing by foot operation.

Because the foot switch makes it possible to operate EQ1 and EQ2 simultaneously with one foot, they can be switched instantaneously.

- Always use the foot switch which is provided. Use of another foot switch can cause a breakdown, so adequate care should be taken.

6

● REAR PANEL

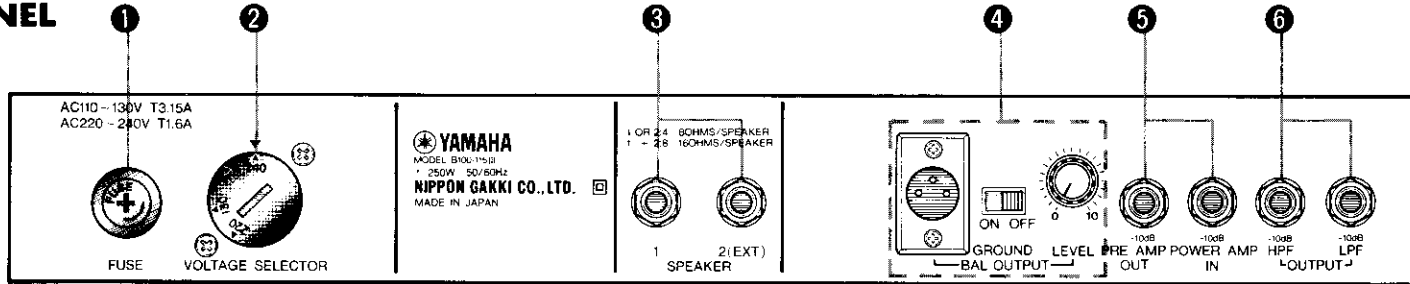

B100-115III (General model)

① FUSE

When replacing the fuse, be sure to first disconnect the AC cord from the outlet. Replace only with a fuse of the same type. If the fuse blows during use of the amplifier, this can be due to mishandling or to an internal defect. Please contact your dealer.

② VOLTAGE SELECTOR (General model only)

Set this to your local AC mains voltage. Failure to do so will result in seriously impaired performance or even severe damage.

● AC OUTLET (Canadian model only)

This is a convenience AC outlet (unswitched) which can be used to supply mains power to other equipment with a maximum power consumption of 250 watts. A delay unit to be used with the guitar amplifier, for example, could be plugged in here.

● GROUND Polarity Switch (Canadian model only)

This switch reverses the polarity of the amplifier ground. When hum and noise is a problem, set the GROUND switch for the least hum and noise.

③ SPEAKER 1 and 2 (EXT) Output Jacks

These jacks are the outputs from the amplifier's power stage, and directly drive the instrument speakers. SPEAKER 1 is normally connected to the amplifier's internal speaker system, while SPEAKER 2 can be connected to an external speaker system where a greater number of speaker units is required.

Note that the minimum allowable total speaker impedance is 4 ohms. This means that on the single-speaker models (internal speaker impedance is 8 ohms), an 8 ohm external speaker plugged into the SPEAKER 2 (EXT) jack in addition to the internal speaker results in a total impedance of 4 ohms. In this case, an external speaker of less than 8 ohms impedance must not be used. The SPEAKER 1 and SPEAKER 2 jacks may be connected to external speakers, each with an impedance of 8 ohms or more.

④ +4dB BAL OUTPUT Connector/LEVEL Control/GROUND Switch

This is a balanced +4dB professional line level output that is ideally suited for directly feeding a sound reinforcement or recording mixer. The LEVEL control adjusts the output level from the balanced connector for optimum matching with the input sensitivity of the external equipment used. Nominal output level is +4 dB

with the level control at center (12 : 00) position, +19dB at maximum setting. The GROUND switch connects or disconnects the connector pin 1 ground, and should be set for minimum hum and noise with the system configuration used.

⑤ PRE AMP OUT/POWER AMP IN

These jacks provide the user with access to the output of the preamp section and the input to the power amp. This is useful for recording the preamp output, driving additional power amplifiers, or as an effects loop for some type of signal processors (Delays, Equalizers) that will operate more quietly after the preamp stage. A signal from another preamplifier can also be sent to the power amp stage via the POWER AMP IN jack, bypassing the internal preamp circuitry. PREAMP OUT and POWER AMP IN level is -10dB.

⑥ HPF OUTPUT/LPF OUTPUT

These outputs send the high and low frequency signals to outboard power amps and speakers. If only the LPF OUTPUT jack is used, the low frequencies are sent to an external power amp, and the high frequencies are automatically sent to the internal power amp/speaker system. Likewise, if only the HPF output jack is used,

used, the low frequencies are automatically sent to the internal power amp/speaker system. If both HPF and LPF outputs are used, the internal power amp/speaker system receives a "full range" signal and all bi-amping occurs in the outboard power amp/speaker equipment used.

EXAMPLE SETUP

Send and return connections

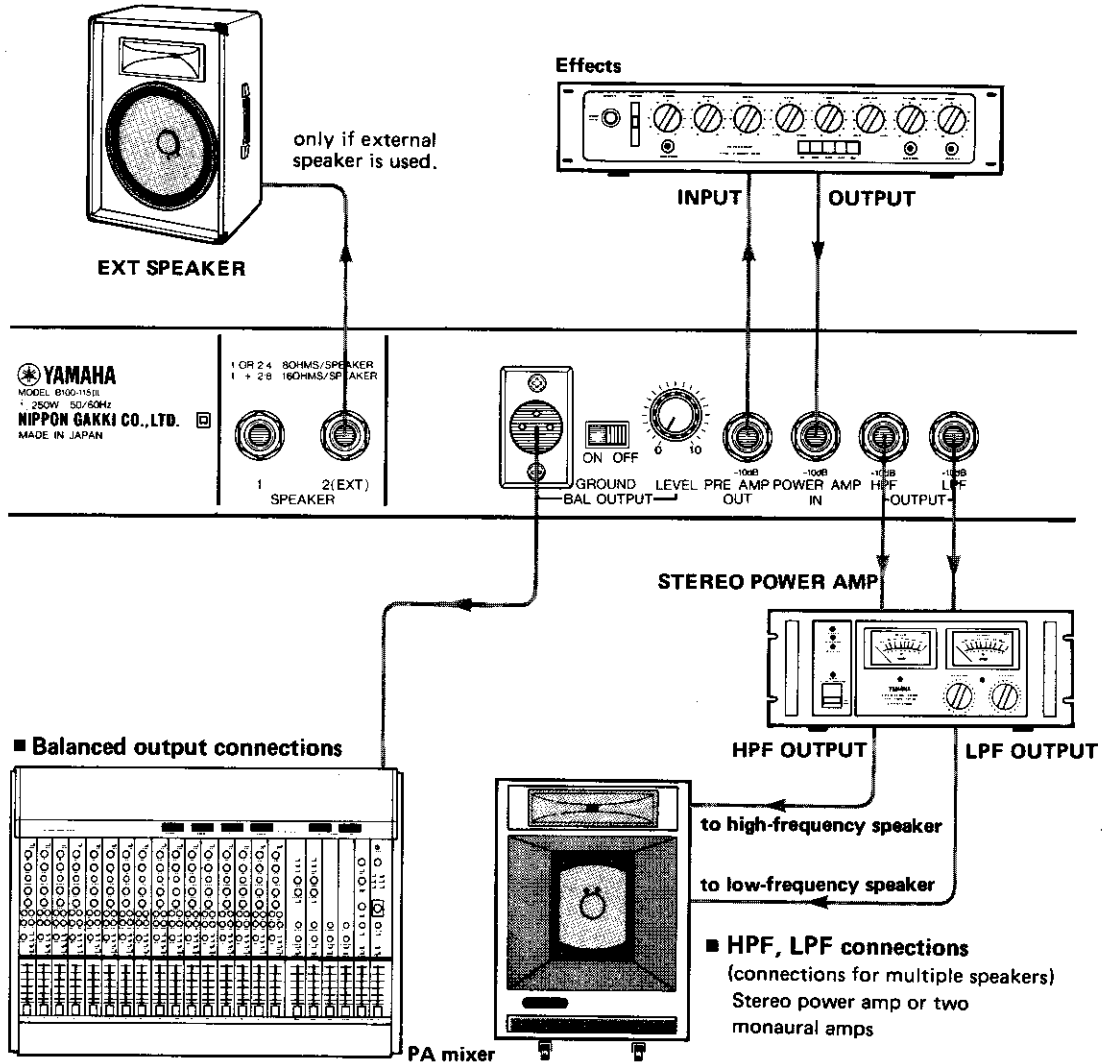

● PARAMETRIC EQ CHARACTERISTICS

● LEVEL CONTROL

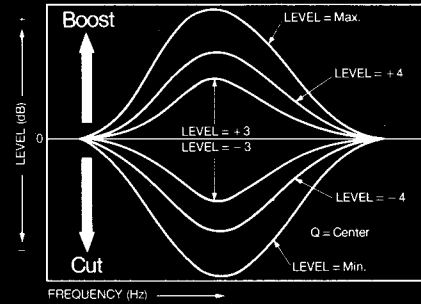

● Q CONTROL

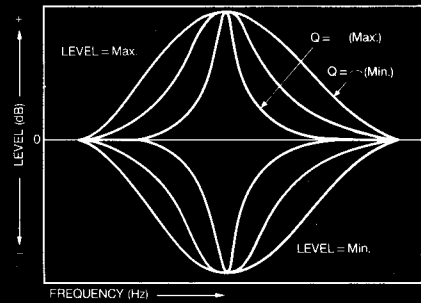

● FREQUENCY CONTROL

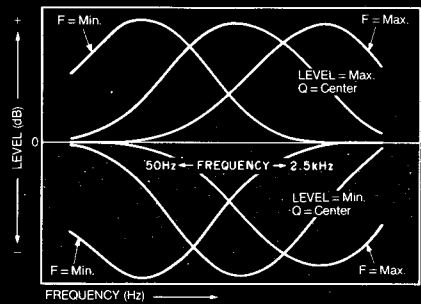

● BLOCK DIAGRAM

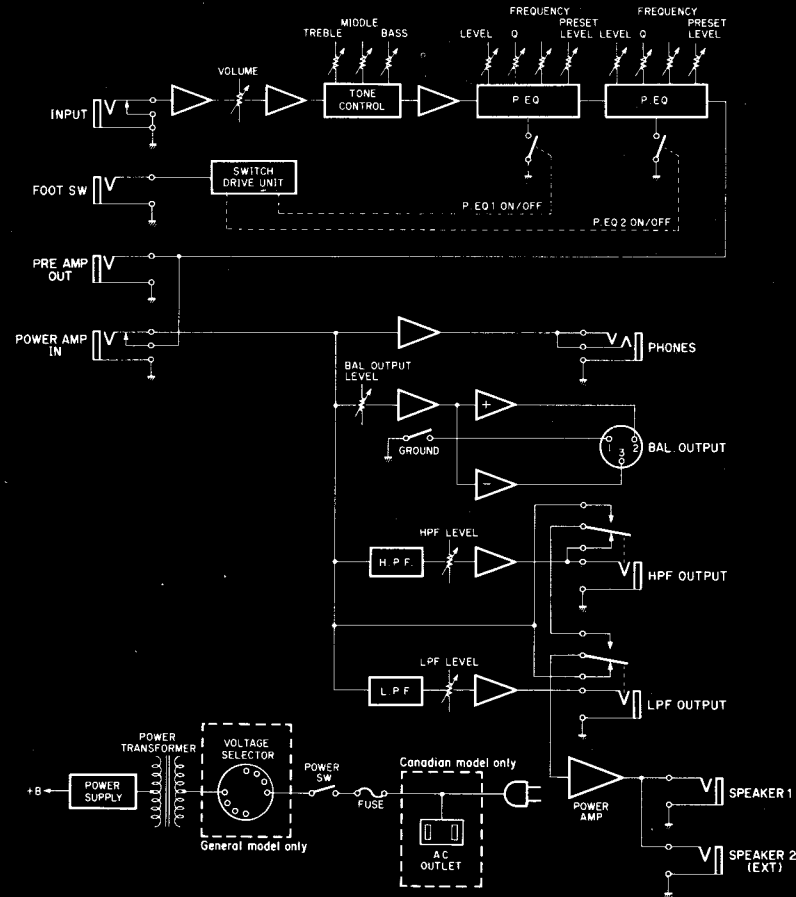

SINCE 1887  **YAMAHA**

NIPPON GAKKI CO., LTD. HAMAMATSU, JAPAN

OMD-87 8690.25  Printed in Japan