

Electone
EL-700/EL-500
OWNER'S MANUAL

SPECIAL MESSAGE SECTION

PRODUCT SAFETY MARKINGS: Yamaha electronic products may have either labels similar to the graphics shown below or molded / stamped facsimiles of these graphics on the enclosure. The explanation of these graphics appears on this page. Please observe all cautions indicated on this page and those indicated in the safety instruction section.

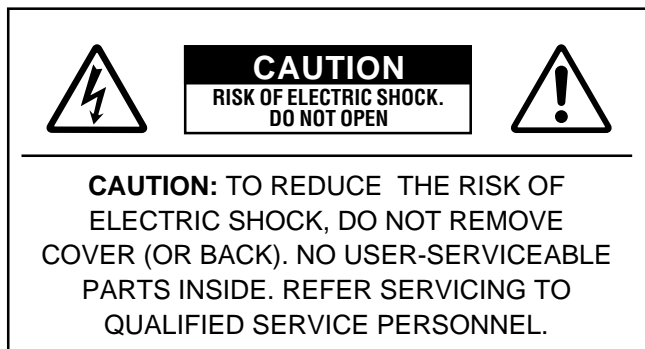

See the name plate for graphic symbol markings.



The exclamation point within the equilateral triangle is intended to alert the user to the presence of important operating and maintenance (servicing) instructions in the literature accompanying the product.

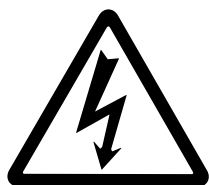

The lightning flash with arrowhead symbol within the equilateral triangle is intended to alert the user to the presence of uninsulated "dangerous voltage" within the product's enclosure that may be of sufficient magnitude to constitute a risk of electrical shock.

IMPORTANT NOTICE: All Yamaha electronic products are tested and approved by an independent safety testing laboratory in order that you may be sure that when it is properly installed and used in its normal and customary manner, all foreseeable risks have been eliminated. DO NOT modify this unit or commission others to do so unless specifically authorized by Yamaha. Product performance and/or safety standards may be diminished. Claims filed under the expressed warranty may be denied if the unit is/has been modified. Implied warranties may also be affected.

SPECIFICATIONS SUBJECT TO CHANGE: The information contained in this manual is believed to be correct at the time of printing. However, Yamaha reserves the right to change or modify any of the specifications without notice or obligation to update existing units.

ENVIRONMENTAL ISSUES: Yamaha strives to produce products that are both user safe and environmentally friendly.

We sincerely believe that our products and the production methods used to produce them, meet these goals. In keeping with both the letter and the spirit of the law, we want you to be aware of the following:

BATTERY NOTICE: This product MAY contain a small nonrechargeable battery which (if applicable) is soldered in place. The average life span of this type of battery is approximately five years. When replacement becomes necessary, contact a qualified service representative to perform the replacement.

WARNING: Do not attempt to recharge, disassemble, or incinerate this type of battery. Keep all batteries away from children. Dispose of used batteries promptly and as regulated by applicable laws. Note: In some areas, the servicer is required by law to return the defective parts. However, you do have the option of having the servicer dispose of these parts for you.

DISPOSAL NOTICE: Should this product become damaged beyond repair, or for some reason its useful life is considered to be at an end, please observe all local, state, and federal regulations that relate to the disposal of products that contain lead, batteries, plastics, etc.

NOTICE: Service charges incurred due to lack of knowledge relating to how a function or effect works (when the unit is operating as designed) are not covered by the manufacturer's warranty, and are therefore the owner's responsibility. Please study this manual carefully and consult your dealer before requesting service.

NAME PLATE LOCATION: The graphic below indicates the location of the name plate. The model number, serial number, power requirements, etc., are located on this plate. You should record the model number, serial number, and the date of purchase in the spaces provided below and retain this manual as a permanent record of your purchase.

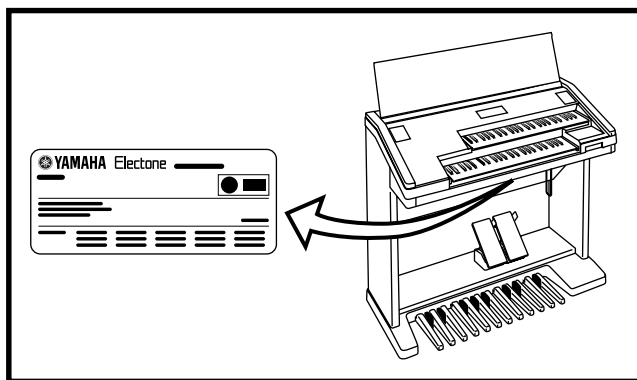

Model _____

Serial No. _____

Purchase Date _____

PRECAUTIONS

PLEASE READ CAREFULLY BEFORE PROCEEDING

* Please keep these precautions in a safe place for future reference.



WARNING

Always follow the basic precautions listed below to avoid the possibility of serious injury or even death from electrical shock, short-circuiting, damages, fire or other hazards. These precautions include, but are not limited to, the following:

- Do not open the instrument or attempt to disassemble the internal parts or modify them in any way. The instrument contains no user-serviceable parts. If it should appear to be malfunctioning, discontinue use immediately and have it inspected by qualified Yamaha service personnel.
- Do not expose the instrument to rain, use it near water or in damp or wet conditions, or place containers on it containing liquids which might spill into any openings.
- If the power cord or plug becomes frayed or damaged, or if there is a sudden loss of sound during use of the instrument, or if any unusual smells or smoke should appear to be caused by it, immediately turn off the power switch, disconnect the electric plug from the outlet, and have the instrument inspected by qualified Yamaha service personnel.
- Only use the voltage specified as correct for the instrument. The required voltage is printed on the name plate of the instrument.
- Before cleaning the instrument, always remove the electric plug from the outlet. Never insert or remove an electric plug with wet hands.
- Check the electric plug periodically and remove any dirt or dust which may have accumulated on it.



CAUTION

Always follow the basic precautions listed below to avoid the possibility of physical injury to you or others, or damage to the instrument or other property. These precautions include, but are not limited to, the following:

- Do not place the power cord near heat sources such as heaters or radiators, and do not excessively bend or otherwise damage the cord, place heavy objects on it, or place it in a position where anyone could walk on, trip over, or roll anything over it.
- When removing the electric plug from the instrument or an outlet, always hold the plug itself and not the cord. Pulling by the cord can damage it.
- Do not connect the instrument to an electrical outlet using a multiple-connector. Doing so can result in lower sound quality, or possibly cause overheating in the outlet.
- Remove the electric plug from the outlet when the instrument is not to be used for extended periods of time, or during electrical storms.
- Before connecting the instrument to other electronic components, turn off the power for all components. Before turning the power on or off for all components, set all volume levels to minimum. Also, be sure to set the volumes of all components at their minimum levels and gradually raise the volume controls while playing the instrument to set the desired listening level.
- Do not expose the instrument to excessive dust or vibrations, or extreme cold or heat (such as in direct sunlight, near a heater, or in a car during the day) to prevent the possibility of panel disfiguration or damage to the internal components.
- Do not use the instrument near other electrical products such as televisions, radios, or speakers, since this might cause interference which can affect proper operation of the other products.
- Do not place the instrument in an unstable position where it might accidentally fall over.
- Before moving the instrument, remove all connected cables.
- When cleaning the instrument, use a soft, dry cloth. Do not use paint thinners, solvents, cleaning fluids, or chemical-impregnated wiping cloths. Also, do not place vinyl, plastic or rubber objects on the instrument, since this might discolor the panel or keyboard.
- Do not rest your weight on, or place heavy objects on the instrument, and do not use excessive force on the buttons, switches or connectors.
- Take care that the key cover does not pinch your fingers, and do not insert a finger or hand in the key cover gap.
- Never insert or drop paper or metallic or other objects between the slits of the key cover and the keyboard. If this happens, immediately turn off the power and remove the electric plug from the outlet and have the instrument inspected by qualified Yamaha service personnel.
- Do not place the instrument against a wall (allow at least 3 cm/one-inch from the wall), since this can cause inadequate air circulation, and possibly result in the instrument overheating.
- Do not operate the instrument for a long period of time at a high or uncomfortable volume level, since this can cause permanent hearing loss. If you experience any hearing loss or ringing in the ears, consult a physician.

■ USING THE BENCH

- Do not play carelessly with or stand on the bench. Using it as a tool or step-ladder or for any other purpose might result in accident or injury.
- Only one person should sit on the bench at a time, in order to prevent the possibility of accident or injury.
- If the bench screws become loose due to extensive long-term use, tighten them periodically using the included tool.

■ SAVING USER DATA

- Always save data to a floppy disk frequently, in order to help prevent the loss of important data due to a malfunction or user operating error.

Yamaha cannot be held responsible for damage caused by improper use or modifications to the instrument, or data that is lost or destroyed.

Always turn the power off when the instrument is not in use.

Congratulations!

You are the proud owner of a fine electronic organ, Electone EL-700/500.

The Yamaha EL-700/500 Electone combines the most advanced AWM tone generation technology with state-of-the-art digital electronics and features to give you stunning sound quality with maximum musical enjoyment.

A large Liquid Crystal Display and sophisticated yet easy-to-use interface also greatly enhance the operability of this advanced instrument.

In order to make the most of the Electone and extensive performance potential, we urge you to read the manual thoroughly while trying out the various features described.

Keep the manual in a safe place for later reference.

Included Items

Registration Menu Disk

3.5" 2HD Floppy Disk

Owner's Manual



Turning the Electone off erases all panel settings you have made. When the Electone is turned on, Basic Registration 1 is automatically selected. If you have made panel settings you wish to keep, save them to Registration Memory before turning the Electone off.



GM (General MIDI System Level 1) is an addition to the MIDI standard which ensures that any GM-compatible music data can be accurately played by any GM-compatible tone generator, regardless of maker. The GM mark is affixed to all software and hardware products that support the General MIDI standard.



XG is a new MIDI format created by Yamaha which significantly improves and expands upon the General MIDI standard by providing a greater variety of high-quality voices plus considerably enhanced effect operation—while being fully compatible with GM.

- The screen displays and illustrations as shown in this owner's manual are for instructional purposes only, and may appear somewhat different from those on your instrument.
- Copying of the commercially available music sequence data is strictly prohibited except for your personal use.
- The company names and product names in this Owner's Manual are the trademarks or registered trademarks of their respective companies.

Table of Contents

EL-700 Panel Layout	6
EL-500 Panel Layout	8
LCD Display/Display Select	10

Main Features 11

1 Quick Introductory Guide 12

1 Getting Started	12
2 Basic Registrations	13
3 Registration Menu Disk	14
4 Basic Operation	19
5 Using the LCD Display	20
6 Voice List	24

2 Voice Sections 26

1 Selecting Voices from the Panel	26
2 Selecting Voices from the Dotted Buttons	29
3 Voice Menus	31

3 Flute Voices (Organ Sounds) - EL-700 only 37

1 Creating Flute Voices	37
2 Save to User Flute Voice	39
3 Using Preset and User Voices	40

4 Voice Controls and Effects 41

1 Selecting from Voice Condition Pages	42
[PAGE 1]	42
1) Touch Tone	42
2) Feet	43
3) Pan	43
4) Reverb	43
5) Volume	43
[PAGE 2]	43
1) Effect (On/Off)	43
2) Brilliance	44
[PAGE 3]	44
1) Vibrato	44
2) Touch Vibrato	45
3) Slide (Lead Voices Only)	45
4) Tune (Lead Voices Only)	45
2 Selecting from Effect Set Pages	45
1) Tremolo/Chorus	46
2) Symphonic/Celeste	46
3) Delay	46
4) Flanger	47
5) Distortion	48
3 Selecting from the Panel	49
1) Reverb	49
2) Sustain	52
3) Tremolo/Chorus	53

5 Rhythm and Accompaniment 56

1 Selecting Rhythms from the Panel	56
2 Rhythm Condition Pages	59
3 Dotted Buttons and User Rhythms	61
4 Rhythm Menus	63
5 Automatic Accompaniment- Auto Bass Chord (A.B.C.)	65
6 Accompaniment Controls	67
7 Preset/User Keyboard Percussion	68
8 Melody On Chord (M.O.C.)	76

6 Registration Memory 77

1 Storing Registrations	77
2 Selecting Registrations	78
3 Saving the Registration Data to Disk	78
4 Registration Shift	79

7 Music Disk Recorder 84

1 Precautions	84
2 Formatting a Disk	86
3 Recording — Punch In Recording	87
4 Recording Registrations (and Bulk Data)	93
5 Recalling Recorded Registrations (and Bulk Data)	94
6 Replacing Registrations	94
7 Playback — About XG Songs	95
8 Other Functions	99

8 Voice Edit 107

1 Editing a Voice	107
2 Saving Your New Voice	112
3 Quitting Voice Edit	114
4 Recalling an Edited Voice	114
5 Selecting Voices from a Voice Disk (Optional)	115
6 Voice Editing Basics	116

9 Rhythm Pattern Program and Rhythm Sequence Program 122

Outline of the Rhythm Programming Operation	122
1 Rhythm Pattern Program	123
1) Entering Rhythm Pattern Program	123
2) Percussion Sounds Used for Rhythm Pattern Program	125
3) Step Write and Real Time Write	127
4) Selecting Step Write or Real Time Write Operation	127
5) Setting the Beat/Quantize Values	127
6) Entering Percussion Sounds to a Rhythm Pattern	128
7) Editing with Step Write	129
8) Editing with Real Time Write	133
9) Selecting Accompaniment Patterns — Lower Rhythmic	134
10) Saving Rhythm Patterns	137
11) Quitting the Rhythm Pattern Program	138
12) Recalling User Rhythm Patterns	139
13) Selecting Rhythm from a Pattern Disk (Optional)	140
2 Rhythm Sequence Program	141
1) Selecting a Sequence	141
2) Programming a Sequence	142
3) Quitting Rhythm Sequence Program	145
4) Playing Rhythm Sequences	145
5) Playing All Sequences in Order	146

10 Footswitches, Knee Lever and Expression Pedals 148

1 Footswitch	148
2 Knee Lever	150
3 Expression Pedals	152

11 Transpose and Pitch Controls 154

12 MIDI 155

13 Accessory Jacks and Controls 157

14 Appendix 158

MIDI	158
MIDI Data Format	164
MIDI Implementation Chart	175
Troubleshooting	177
Specifications	180
Index	182

1 Quick Introductory Guide

2 Voice Sections

3 Flute Voices (Organ Sounds) - EL-700 only

4 Voice Controls and Effects

5 Rhythm and Accompaniment

6 Registration Memory

7 Music Disk Recorder

8 Voice Edit

9 Rhythm Pattern Program and Rhythm Sequence Program

10 Footswitches, Knee Lever and Expression Pedals

11 Transpose and Pitch Controls

12 MIDI

13 Accessory Jacks and Controls

14 Appendix

EL-700/500 Panel Layout

EL-700 Panel Layout

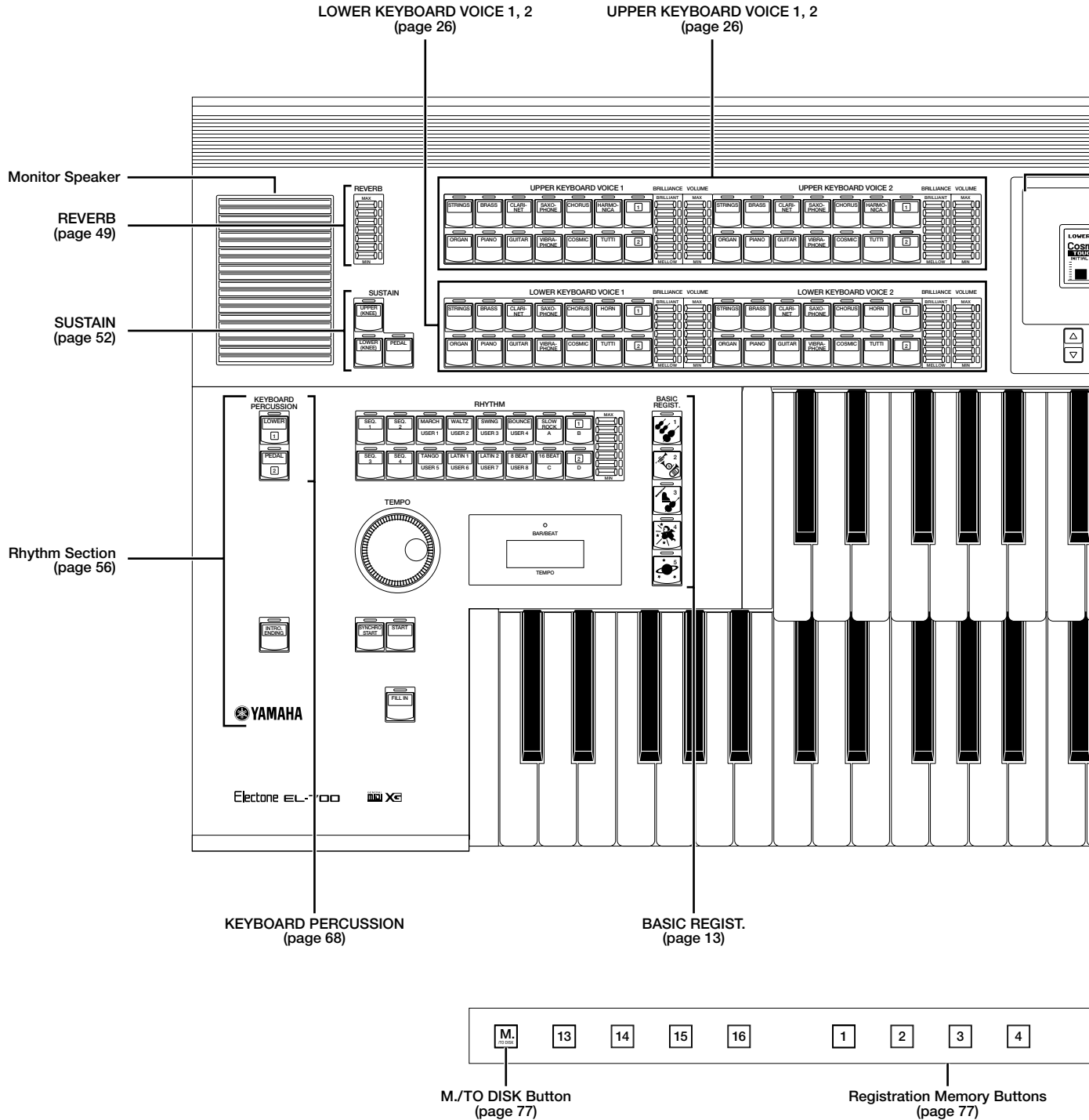

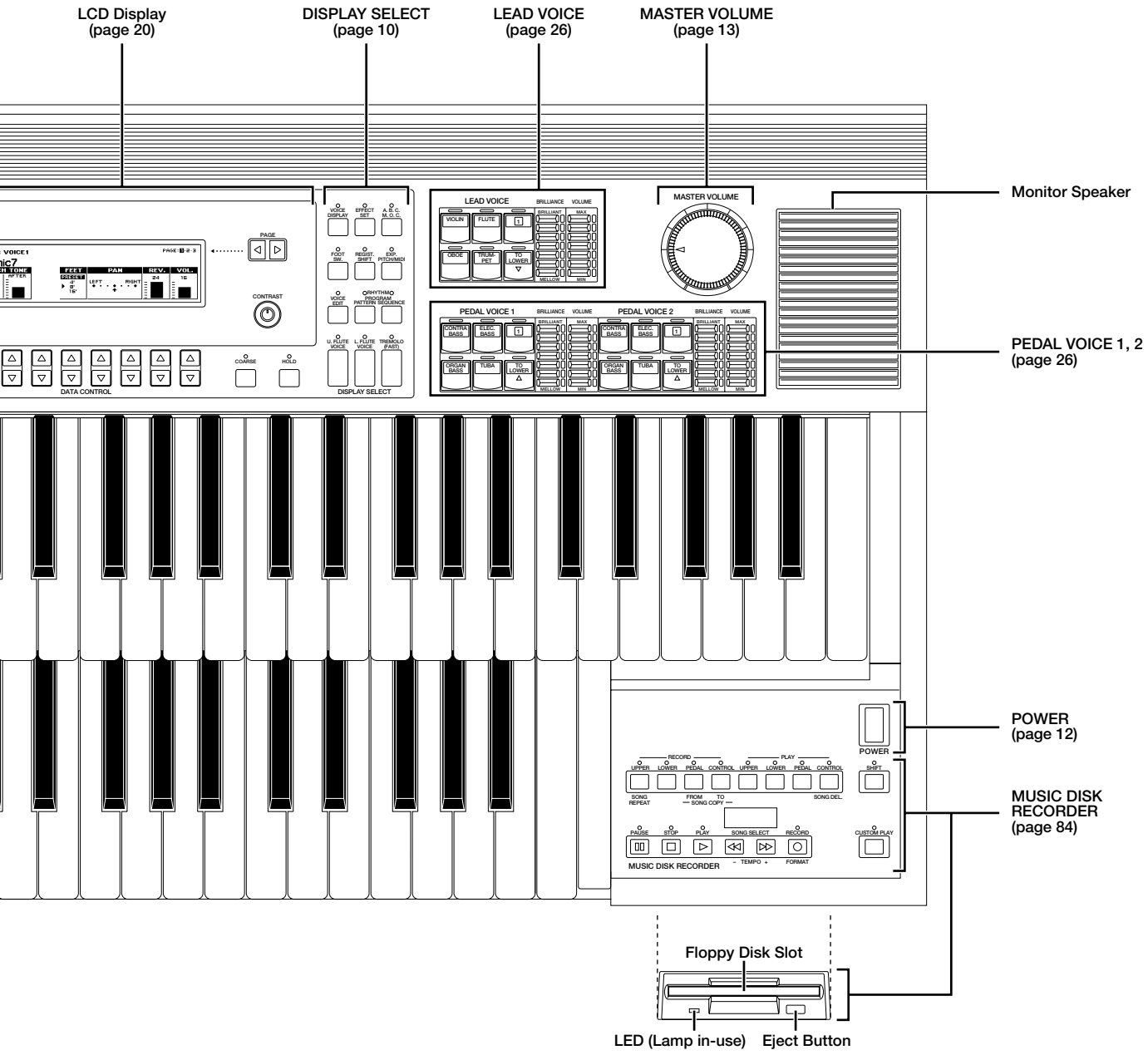

LCD Display
(page 20)

DISPLAY SELECT
(page 10)

LEAD VOICE
(page 26)

MASTER VOLUME
(page 13)

Monitor Speaker

PEDAL VOICE 1, 2
(page 26)

POWER
(page 12)

MUSIC DISK
RECORDER
(page 84)

Floppy Disk Slot
LED (Lamp in-use) Eject Button

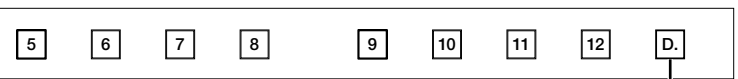

D. (Disable) Button
(page 77)

EL-500 Panel Layout

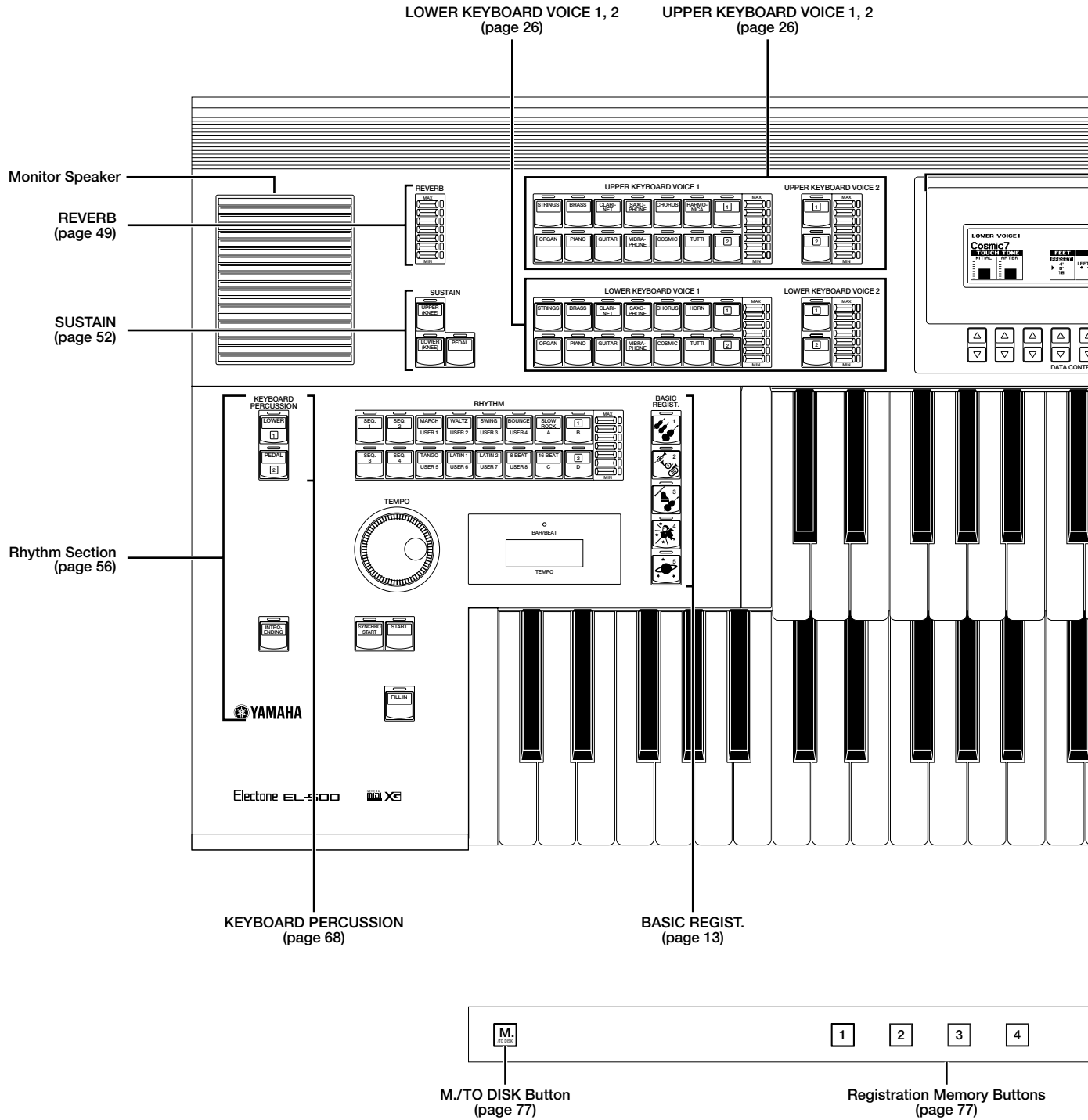

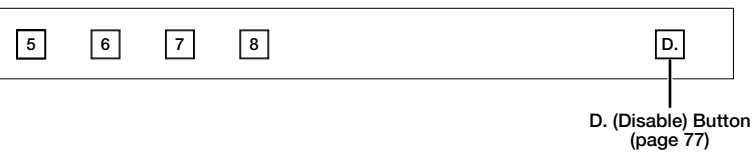
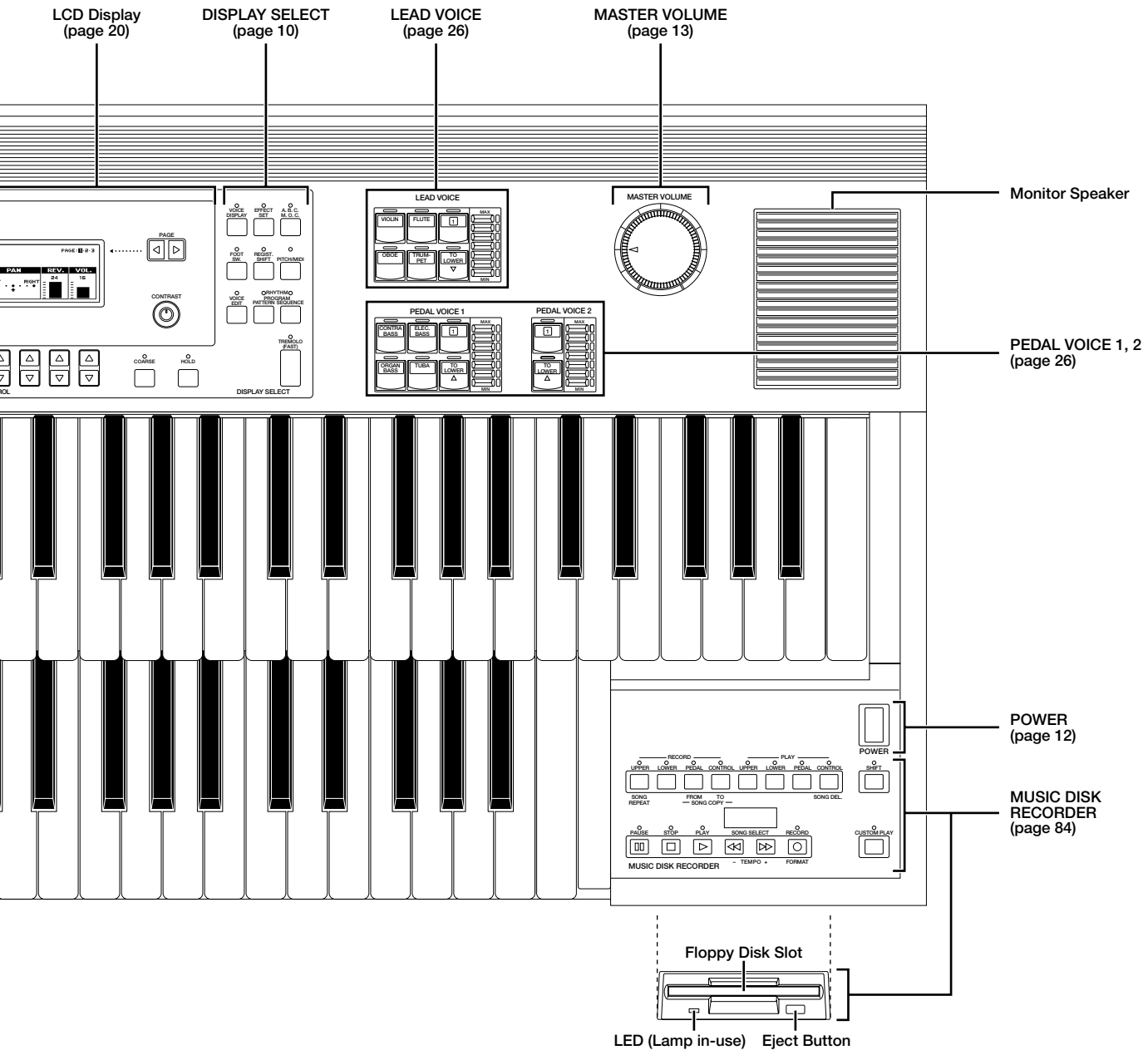

LCD Display/Display Select

EL-700

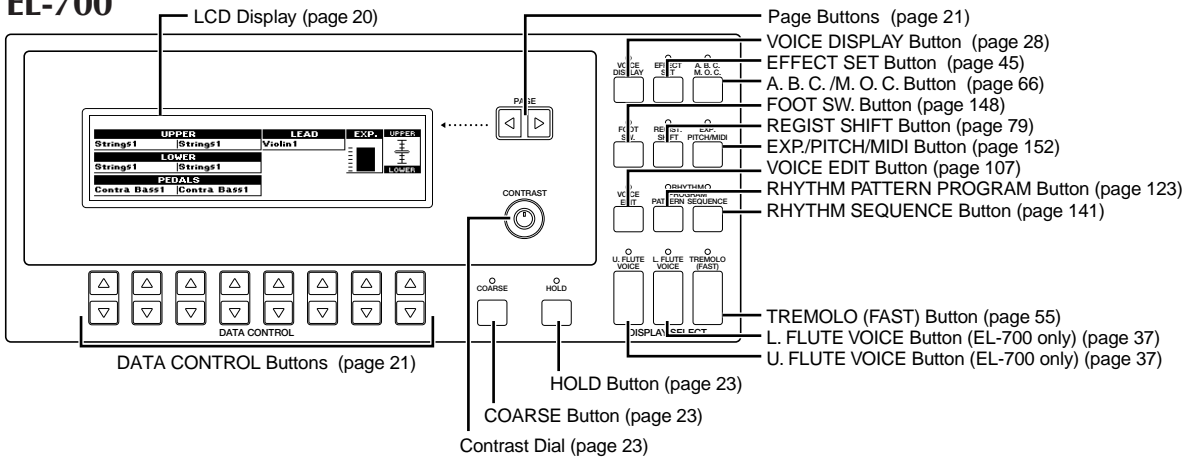

EL-500

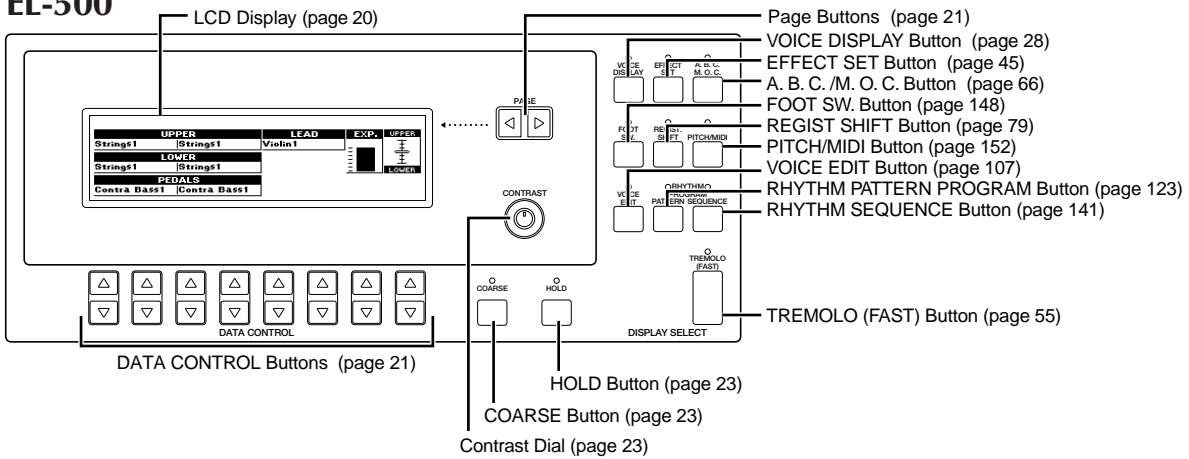

Others

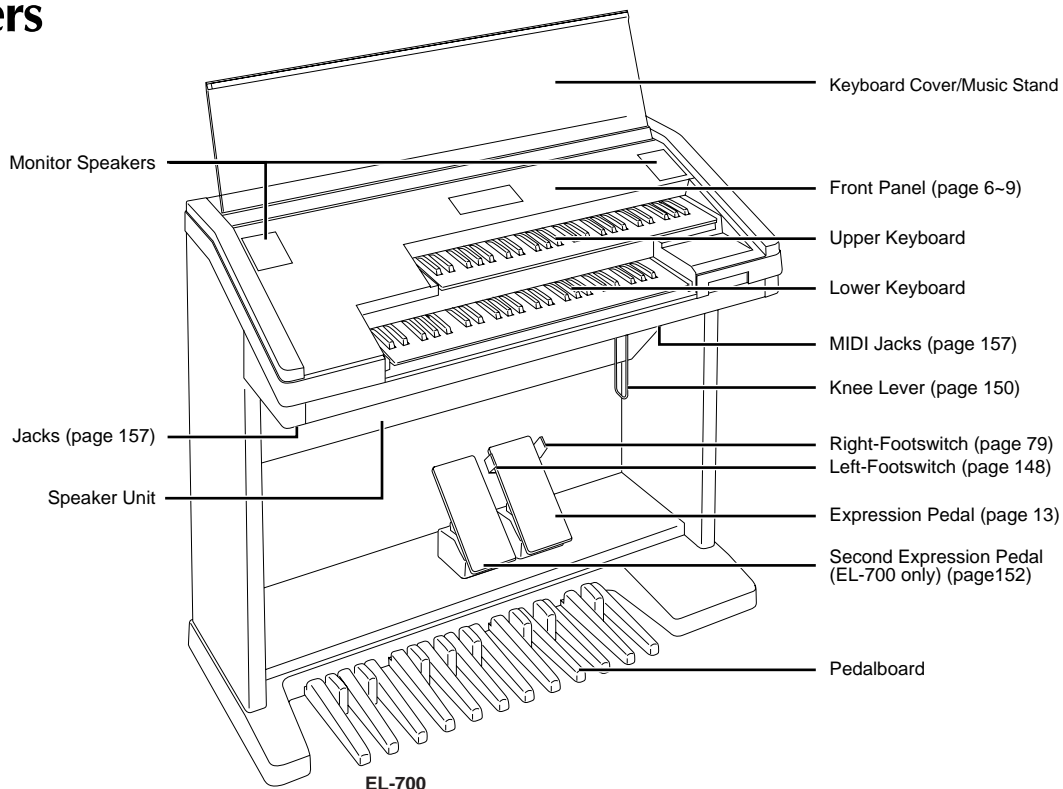

Main Features

Your Yamaha Electone is packed with many sophisticated functions. Yet is amazingly easy to use. The main features are briefly described here so that you can quickly understand the capabilities of your Electone.

Included among the main features are:

1 Astoundingly True-to-life Sounds

The new AWM (Advanced Wave Memory) and FM (Frequency Modulation) tone generation technologies combined with authentic touch response make this Electone a truly expressive musical instrument.

You can enjoy playing a total of 173 AWM/FM voices using the touch response function. (page 26)

2 Limitless Variety of Organ Sounds (EL-700 only)

The Electone also has separate voice sections that feature classic organ sounds—from jazz and pop to church and theater—and lets you easily create your own organ sounds by adjusting the volumes of the various flute footages. (page 37)

3 Original Voice Creation

The Electone also provides easy-to-use voice editing tools for manipulating the sophisticated AWM and FM tone generation technologies, allowing you to create your own original Electone voices. (page 107)

4 Dynamic and Programmable Rhythm Patterns

The Rhythm section of the Electone features authentic drum and percussion sounds, used by expert rhythm programmers in creating a total of 66 rhythm patterns, ranging across all styles of music. (page 56)

Along with the Keyboard Percussion function (page 68), which lets you play 120 different percussion sounds from the keyboard, the Rhythm Pattern Program and Rhythm Sequence Program functions let you record your own rhythm patterns and connect them to make songs. (page 122)

5 Wide Variety of Effects

Electone voices can also be enhanced with a full range of high-quality digital effects, ranging from Tremolo and Reverb to Flanger, Delay and Distortion. Pan and Reverb can be applied to each voice and each percussion sound independently. (page 41)

6 Versatile Functions of the Music Disk Recorder

The Electone also features a Music Disk Recorder (MDR) for recording your registrations and performances to a floppy disk. In addition, the MDR allows you to copy a song from a disk to another, duplicate a disk, and play and save commercially available XG song data. (page 84)

7 Large LCD for Systematic, Intuitive Operation

The large (320 x 80 full dot) LCD display provides comprehensive and easy-to-understand control over virtually all of the operations of the Electone.

Quick Introductory Guide

Whether you are an advanced Electone performer or have never touched an electronic keyboard in your life, we recommend that you take the time to go through this basic section. It shows you in the simplest possible manner how to start playing your Electone. The basic operations and functions that you learn in this section will also be important when you later use the Electone's more advanced features.

1 Getting Started



Only use the voltage specified as correct for the Electone. The required voltage is printed on the name plate of the Electone.

Yamaha products are manufactured specifically for the supply voltage in the area where they are to be sold. If you should move, or if any doubt exists about the supply voltage, please consult with a qualified technician.

1

Plug the power cord in to an appropriate electrical outlet.

2

Turn on the Electone by pressing the POWER switch.

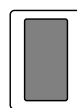

POWER

When you turn on the Electone, the following displays will appear one after the other on the LCD display:

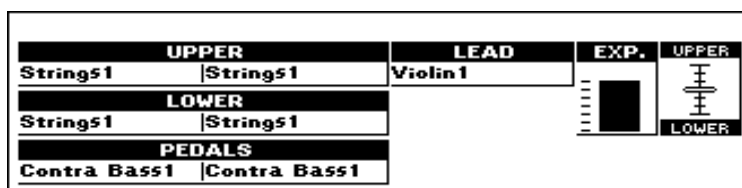
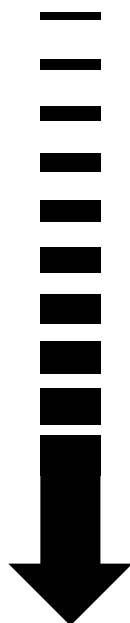

This last display shows the currently assigned voice settings for each voice section, as well as the overall balance between the Upper and Lower voices.

When the Electone is turned on, Basic Registration 1 is automatically selected.

- 3** Set the MASTER VOLUME control.
The MASTER VOLUME control is an overall control which affects the volume of the entire instrument.

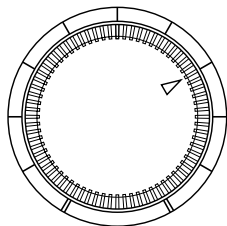

MASTER VOLUME

- 4** Press the Expression pedal down with your foot.
Once you have set the MASTER VOLUME control to a suitable level, you can use the Expression pedal to change the volume with your foot as you play.

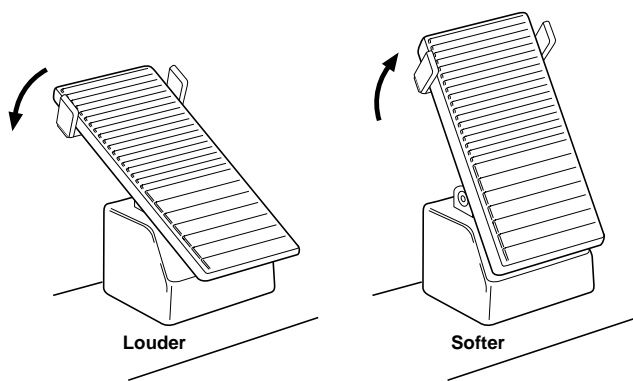

UPPER		LEAD	EXP.	UPPER
String51	String51	Violin1	[Volume indicator]	UPPER LOWER
LOWER				
String51	String51			
PEDALS				
Contra Bass1	Contra Bass1			

2 Basic Registrations

The Basic Registration section has five factory preset registrations, each with a different set of voices for the Upper/Lower keyboards and Pedalboard and each specially suited for playing in a different music style.

To select Basic Registrations:

When you turn the power on, the Electone automatically selects Basic Registration 1. Press the BASIC REGIST. buttons to select each Basic Registration.

The chart below lists the voices that have been set for the Upper/Lower keyboards and Pedalboard in each of the five Basic Registrations.



	Basic Registration 1	Basic Registration 2	Basic Registration 3	Basic Registration 4	Basic Registration 5
Upper Keyboard Voice 1	Strings 1	Brass 1	Flute 1	Cosmic 1	Synth. Brass 1
Lower Keyboard Voice 1	Strings 1	Horn1	Piano 1	Cosmic 2	Cosmic 3
Pedal Voice 1	Contra Bass1	Tuba	Contra Bass 1	Cosmic 2	Synth. Bass 1



Turning the Electone off erases all panel settings you have made. When the Electone is turned on, Basic Registration 1 is automatically selected.

If you have made panel settings you wish to keep, save them to Registration Memory (page 77) before turning the Electone off. You can, however, restore the panel settings that were made before the Electone was last turned off. See page 83 for more information.

3 Registration Menu Disk

The Electone includes convenient Registrations that let you completely and instantly change the voices and other settings for all of the keyboards, even as you play. Each registration is pre-programmed to be used for a specific music style or instrumental combination. Included with your Electone is a Registration Menu Disk. The disk is packed with 80 different types of registrations, including voice and rhythm selections. Each registration is pre-programmed to be used for a specific music style or instrumental combination.



NOTE:

See page 84 for more information on the Music Disk Recorder.



NOTE:

See page 16 for the complete list of the Registration Menus.



NOTE:

While you are in the Voice Edit mode or Rhythm Pattern/Sequence Program mode, the Registration Menu cannot be displayed on the LCD.

To select registrations from the Registration Menu Disk:

- Put the included Registration Menu Disk (with the label of the disk facing upward and the sliding shutter facing forward) into the Disk slot, located just under the Music Disk Recorder at the right side of the Electone. Once you've securely inserted the disk into the slot, the LCD Display on the panel will automatically change to show the available Registration Menus. There are dozens of registrations on a disk, but up to 16 can only be shown in the LCD Display at a time. The page numbers 1 through 5 shown at the top right corner of the LCD indicate this Registration Menu Disk contains five pages.

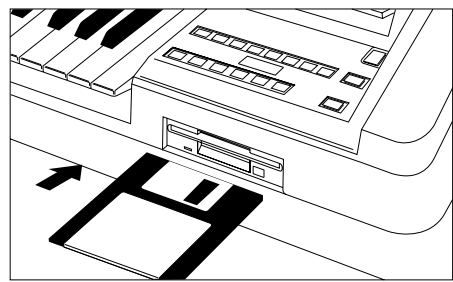

REGIST DISK								PAGE: 1-2-3-4-5
Symphonic Orchestra								
Maestoso	Grand Orch.	Full St.	Str. Ens.	LowSt &Harp	Pizz. Ens.	Class icEns	Woods Quart	
Flute &Harp	Fanfara re	Brass Ens.	PfCli max	Baroq ue	VI.Ro coco	Str. Quart	Choir Tutti	

- Press the Page button to select the various menu "pages" of registrations available on the disk.

REGIST DISK								PAGE: 1-2-3-4-5
Latin								
Samba Brass	Samba Light	Bossa Combo	Bossa Str.	Mambo Slow	Mambo Fast	Rhumb a	Begui ne	
Cha - Cha	Salsa	Tango Argen	Tango Conti	Mexic an	Viva! Bamba	Jamai can15	Jamai can12	

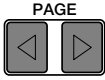

When the page numbers are displayed at the top right corner, you can select the pages by pressing the Page buttons, [▶] to select next page and [◀] to select previous page.

3 Select one of the registrations shown on the LCD by pressing the appropriate Data Control button.



Up to 16 registration selections are shown on the LCD, and the 16 Data Control buttons correspond to those selections.

The Data Control buttons are used to select voices, rhythms and various functions. They are also used to raise or lower volumes and levels, as well as move the cursor up and down, right and left.

 **NOTE:**

Inadvertently pressing another button on the panel may change the content of the LCD during the Registration Menu operation. In this case press PLAY button on the Music Disk Recorder section, to retrieve the Registration Menu display.

Registration Menu List

Page 1: Symphonic Orchestra

	LCD (Name)	Content
1	Maestoso	Symphonic Orchestra 1
2	GrandOrch.	Symphonic Orchestra 2
3	Full St.	String Ensemble 1
4	Str. Ens.	String Ensemble 2
5	LowSt&Harp	Strings & Harp
6	Pizz.Ens.	Pizz. Strings
7	ClassicEns	Classical Orchestra
8	WoodsQuart	Wood Ensemble
9	Flute&Harp	Flute & Harp
10	Fanfare	Brass Ensemble 1
11	BrassEns.	Brass Ensemble 2
12	PfClimax	Piano Concerto
13	Baroque	Baroque 1
14	VI.Rococo	Baroque 2
15	Str. Quart	String Quartet
16	ChoirTutti	Orchestra w/choir

Page 2: Twilight Illumination ~ Jazz Time

	LCD (Name)	Content
1	Sax. Full	Big Band Orchestra 1
2	Full Brass	Big Band Orchestra 2
3	Mute Ens.	Big Band Orchestra 3
4	SolidTutti	Big Band Orchestra 4
5	Moon Light	Big Band Orchestra 5
6	Trb. Ens.	Big Band Orchestra 6
7	Quartet	Quartet
8	Cocktail	Quintet
9	BeBop	Be Bop
10	Afro'Jazz	Afro Cuban
11	Jazz VI.	Jazz Violin
12	SwingWaltz	Jazz Waltz
13	Fast Combo	Combo Jazz
14	Dixie	Dixieland Jazz
15	RadioDays	Ragtime
16	Charleston	Charleston

Page 3: Latin

	LCD (Name)	Content
1	SambaBrass	Samba 1
2	SambaLight	Samba 2
3	BossaCombo	Bossanova 1
4	BossaStr.	Bossanova 2
5	MamboSlow	Mambo 1
6	MamboFast	Mambo 2
7	Rhumba	Rhumba
8	Beguine	Beguine
9	Cha - Cha	Cha - Cha
10	Salsa	Salsa
11	TangoArgen	Tango 1
12	TangoConti	Tango 2
13	Mexican	Mexican 1
14	Viva!Bamba	Mexican 2
15	Jamaican16	Caribbean 1
16	Jamaican12	Caribbean 2

Page 4: Dance & Fusion

	LCD (Name)	Content
1	Disco	70's Disco
2	DancePop	80's Dance
3	Euro Beat	Euro Beat
4	WorldCup	Latin Beat
5	Funk	Funk
6	DanceClass	Dance Classic
7	R&R	Oldies 1
8	Twist	Oldies 2
9	Bounce	16 Beat Shuffle
10	BritePiano	16 Beat 1
11	Sax.&Synth	16 Beat 2
12	JazzFusion	Jazz Fusion
13	OceanGtr.	West coast 1
14	16Bt.Pf	West coast 2
15	16Bt.Balad	16 Beat Ballad
16	16Bt.Latin	16 Beat Latin

Page 5: Black & White ~ Organ Sounds

	LCD (Name)	Content
1	Straight	Flute Combi. 1
2	Cluster	Flute Combi. 2
3	Dry Combi	Flute Combi. 3
4	Fat & Rich	Flute Combi. 4
5	Moody	Jazz Ballad 1
6	Full Balad	Jazz Ballad 2
7	LightCombi	Organ Bossa 1
8	OrganCla.	Organ Bossa 2
9	WhiteShade	8 Beat Ballad 1
10	Pale Great	8 Beat Ballad 2
11	MetalCombi	Rock Organ 1
12	Blues	Rock Organ 2
13	Cathedral	Cathedral
14	Chapel	Chapel
15	Carousel	Carousel
16	Stadium	Stadium

4 Basic Operation

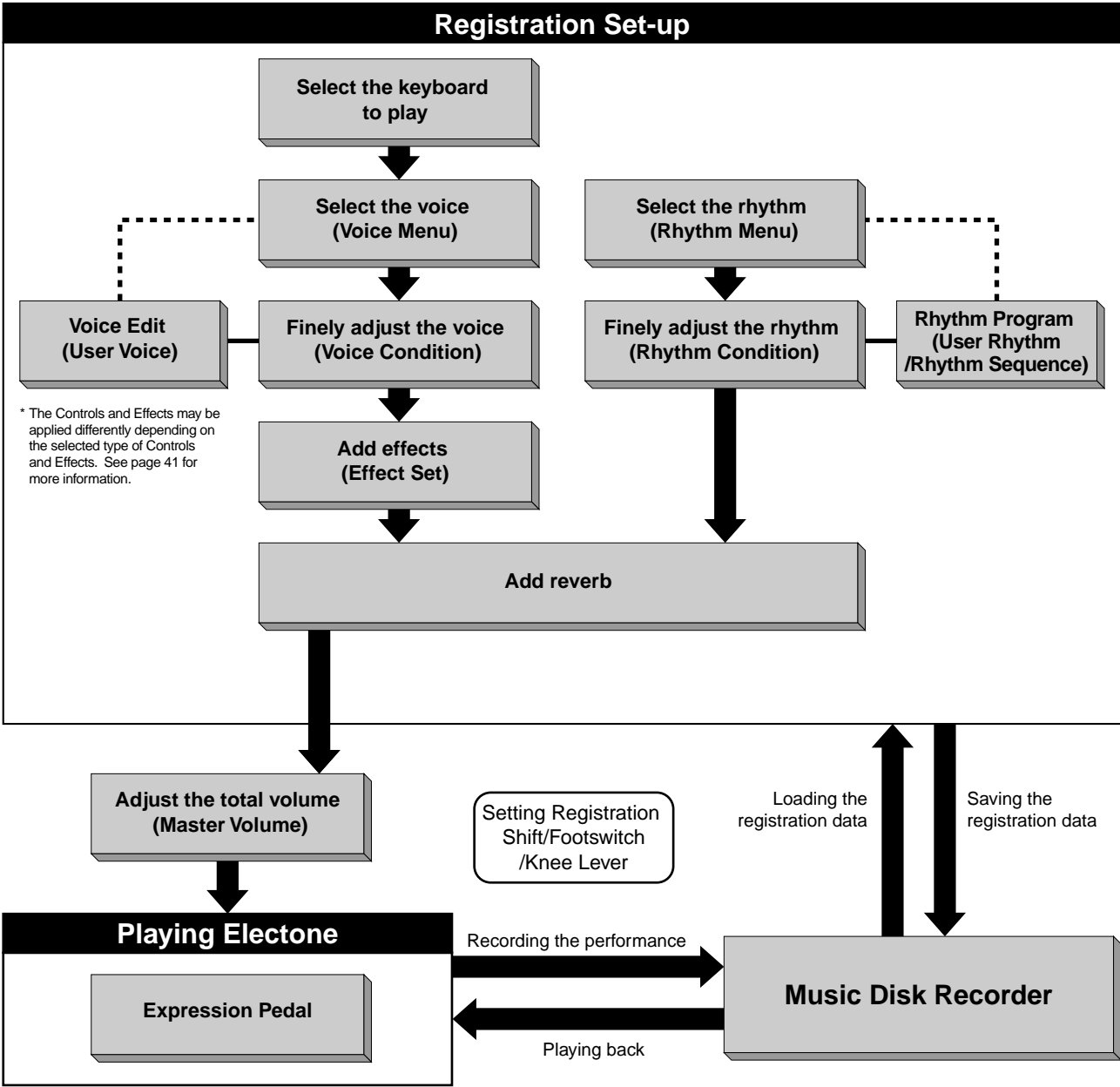

5 Using the LCD Display

This section introduces you the convenient control functions of the LCD display. The LCD display lets you see at a glance the current settings and provides easy-to-understand graphic representation of all parameters.

Selecting a voice/rhythm

1 Press the panel voice/rhythm button which you want to use (For example, press the STRINGS button in the Upper Keyboard Voice 1 section).

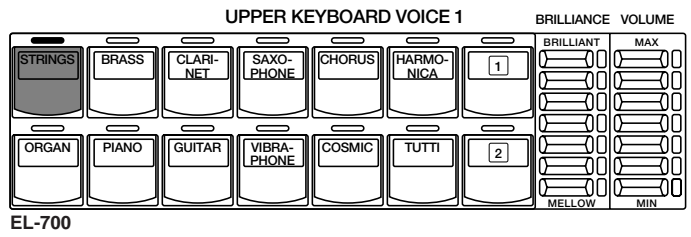

The following display will appear, showing all the available voices/rhythms in the category (Strings Category in this case).

UPPER VOICE 1							
Strings 1							
STRINGS							
Strings 1	Strings 2	Strings 3	Strings 4	Strings 5	Strings 6	Strings 7	STRINGS
Pizz. Strings	Trem. Strings			Synth. Strs.1	Synth. Strs.2	Synth. Strs.3	

2 Press the Data Control button corresponding to the voice you want to play (Strings 3 in this case).

UPPER VOICE 1							
Strings3							
STRINGS							
Strings 1	Strings 2	Strings 3	Strings 4	Strings 5	Strings 6	Strings 7	STRINGS
Pizz. Strings	Trem. Strings			Synth. Strs.1	Synth. Strs.2	Synth. Strs.3	

△

△

△

△

△

△

△

△

▽

▽

▽

▽

▽

▽

▽

▽

The selected voice/rhythm will be shown in the reversed box.

Using Data Control Buttons

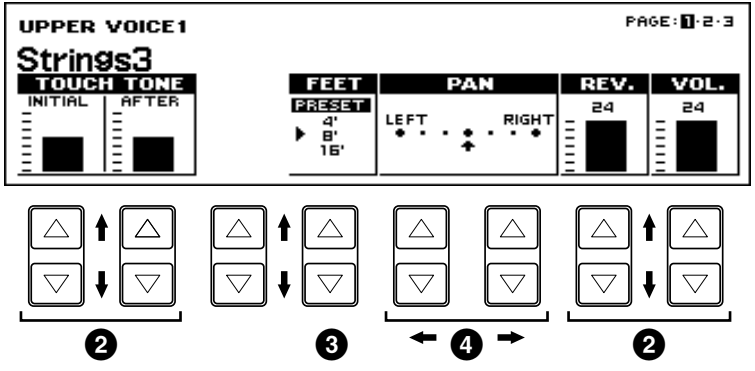
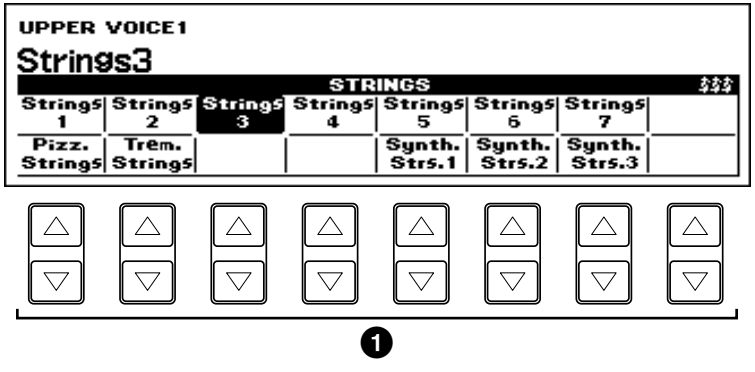

The Data Control buttons are used to select ① a voice/rhythm or function shown on the display.

Press the STRINGS button in the Upper Keyboard Voice 1 section once again.

This LCD changes to show some of the other ways in which the Data Control buttons are used to control Electone functions.

Each pair of buttons corresponding to the section of the display directly above it increases/decreases ② the value or chooses ③ a setting/function. When you are setting the Pan position, each of them moves the cursor ④ to the right/left.

Using Page Buttons

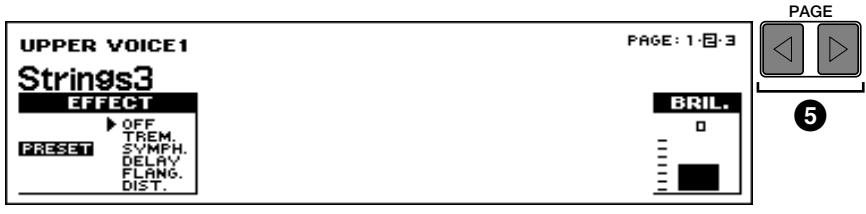

These buttons are used to select (when available) the various “pages” of the display, the names of which appear at the top right of the LCD. Use Page [▶] to select the next page, and Page [◀] to select the previous page.

1. To call up the LCD display

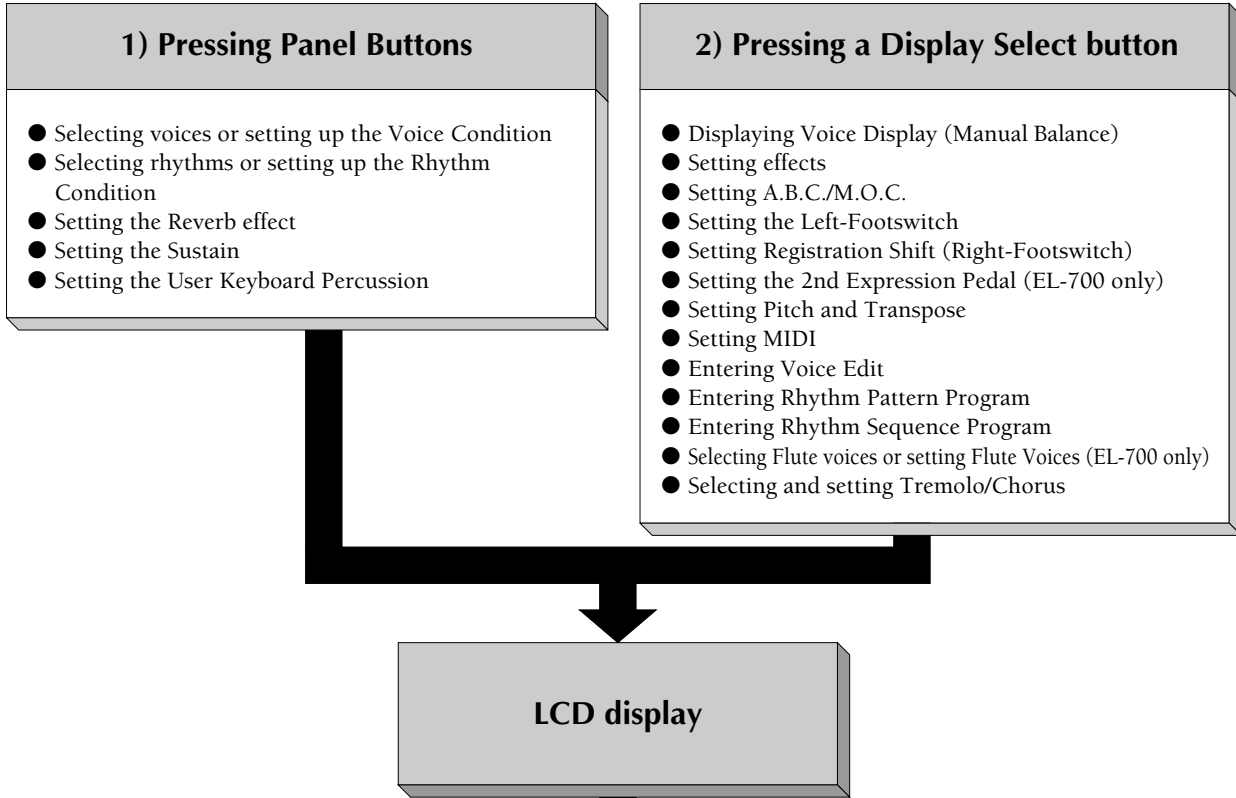

2. To Select Pages

Selecting the page you want to use with the Page buttons

3. To Actually Change the Settings

Using the Data Control buttons to:

- Select voices/rhythms/effects
- Turn on/off the Accompaniment and A.B.C. Memory
- Adjust Touch Tone and Reverb depth
- Edit the rhythm pattern/sequence
- Move the pan position and cursor position

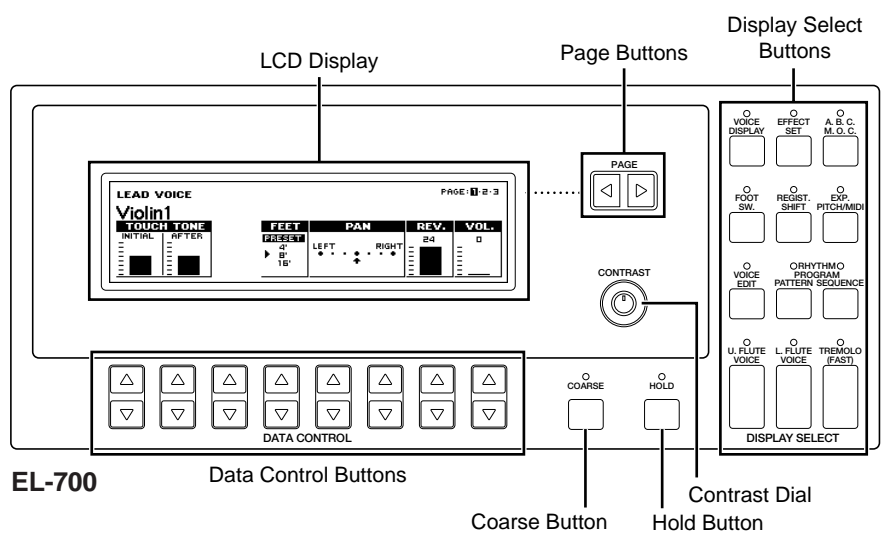

Hold

This button allows you to keep the LCD display at the current function. Normally, if the buttons of other functions are pressed, the LCD will switch to those functions. To keep this from happening, press the Hold button; the button's LED will remain lit as long as Hold is in effect. Press the button again to cancel Hold.

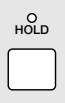

Coarse Button

This button allows you to make quick “jumps” when changing values (of the parameters with bar indications). While holding the Coarse button down, press the Data Control button corresponding to the value you wish to change; the values will change rapidly toward the maximum or minimum.



Contrast Dial

The Contrast Dial at the right side of the LCD display can be used for adjusting the relative sharpness of the characters displayed on the LCD.



6 Voice List

A variety of voices can be divided into the following categories.

ORCHESTRAL

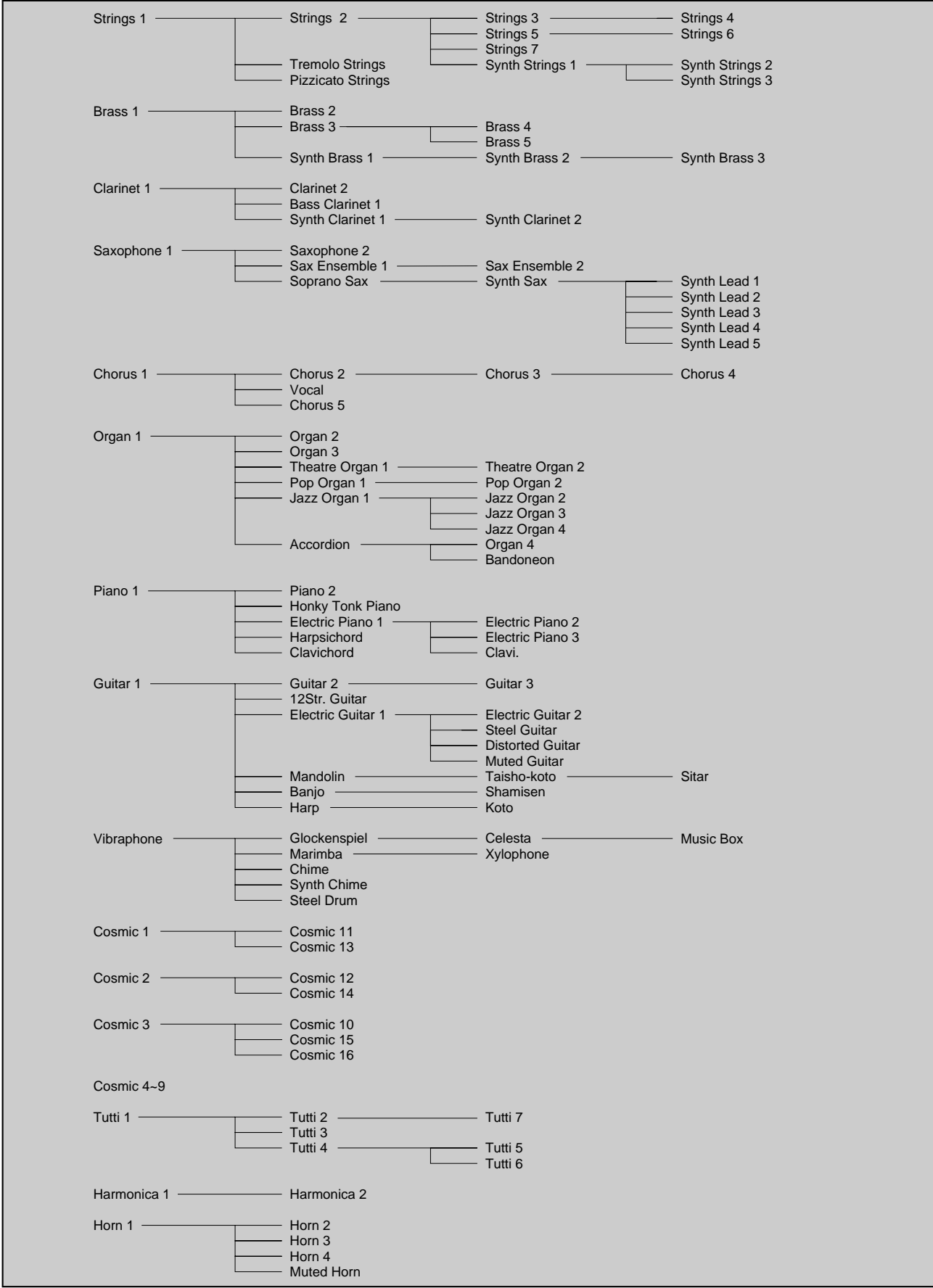

LEAD

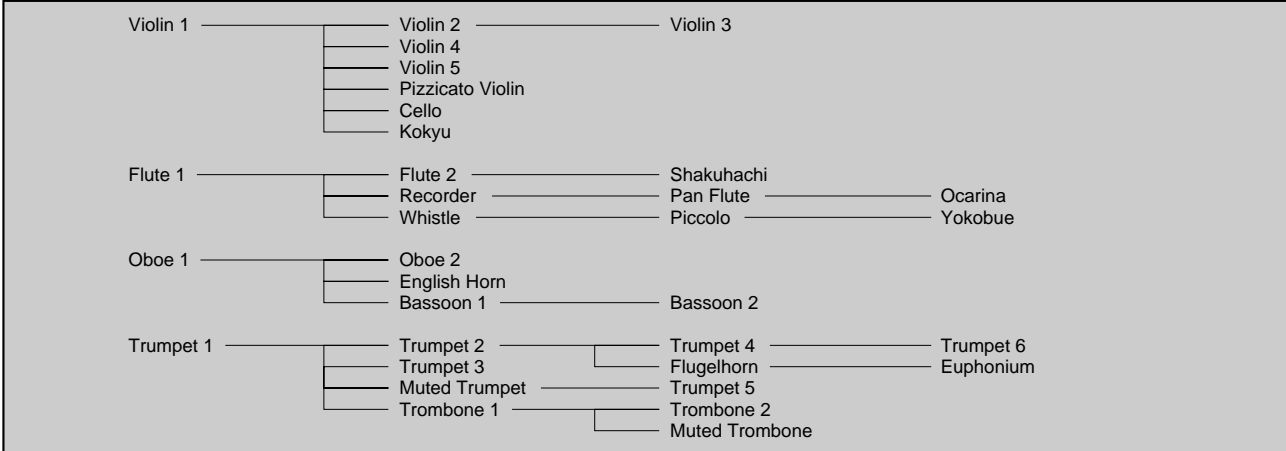

BASS

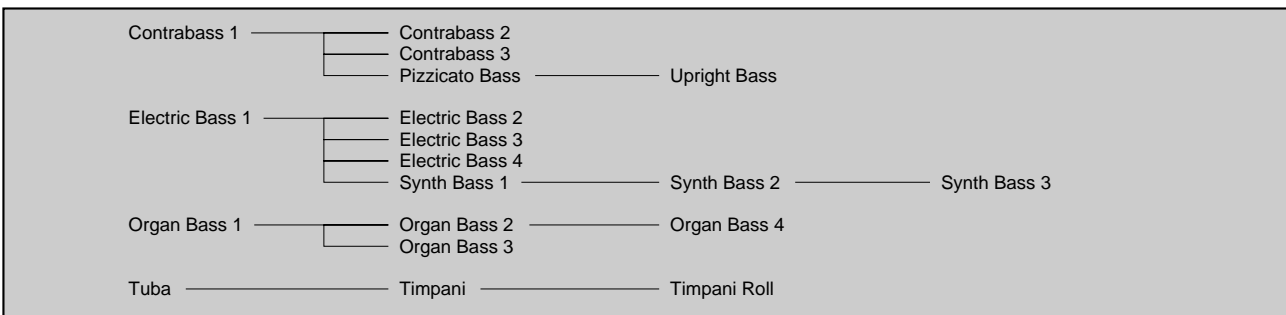

The Preset Voices for Upper/Lower Flute Voices (EL-700 only)

Jazz Organ 1	Jazz Organ 2	Jazz Organ 3	Jazz Organ 4
Pop Organ 1	Pop Organ 2	Pop Organ 3	Pop Organ 4

The EL-700/500 features 173 different high quality AWM/FM voices. Each of the AWM/FM voices can be used on the Upper keyboard, Lower keyboard and Pedalboard.

There are three voice sections for the Upper keyboard, two voice sections for the Lower keyboard and Pedalboard. Each voice section can, of course, have its own Voice Condition page(s), which allow you to finely set up voice and volume settings.

EL-700

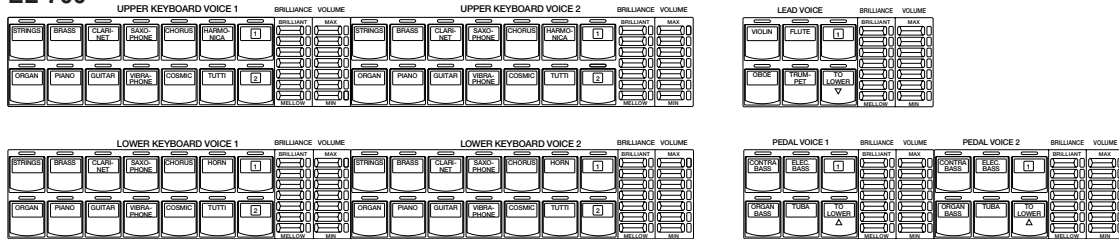

EL-500

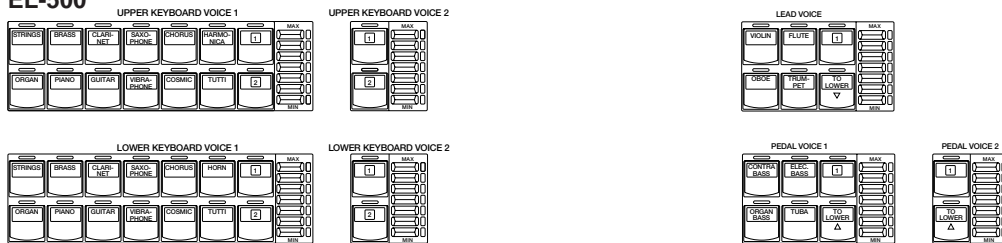

* The illustrations of the EL-700 will be used for instruction in the following sections.

1 Selecting Voices from the Panel

Since selection of panel voices follows the same procedure throughout the various voice sections, instructions for only the Upper Keyboard Voice 1 are given here.

To select voices:

- Select a voice from the Upper Keyboard Voice 1 section by pressing one of the Voice buttons in that section.



NOTE:
To the EL-500 owners: The voices from the Upper Keyboard Voice 2, Lower keyboard Voice 2 and Pedal Voice 2 can be selected differently. See "2. Selecting Voices from the Dotted Buttons" on page 29 for the information how to select a voice.

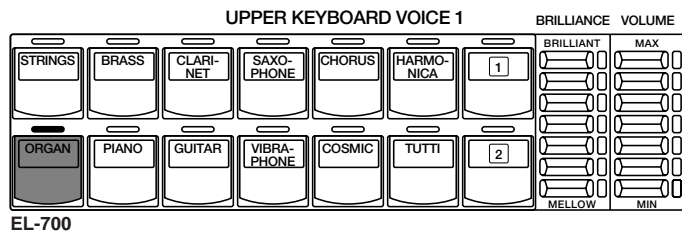

NOTE:
For the detailed information on the AWM/FM tone generation system see page 117.

If, for example, you have selected the ORGAN voice, the following display (Voice Menu) will appear:

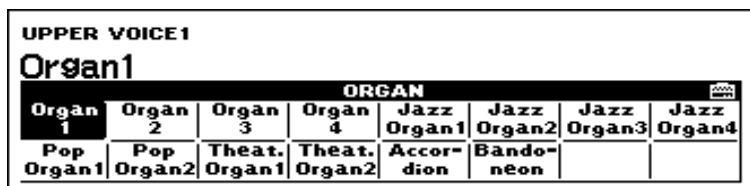

NOTE:
Voices of the Upper and Lower Flute Voice sections (EL-700 only) are selected by a different procedure. Refer to the section Flute Voices on page 37 for details.

Notice that several different voice names are shown on this display. These are variations of the basic organ voice category.

2 Press one of the Data Control buttons that corresponds to voice you wish to select.

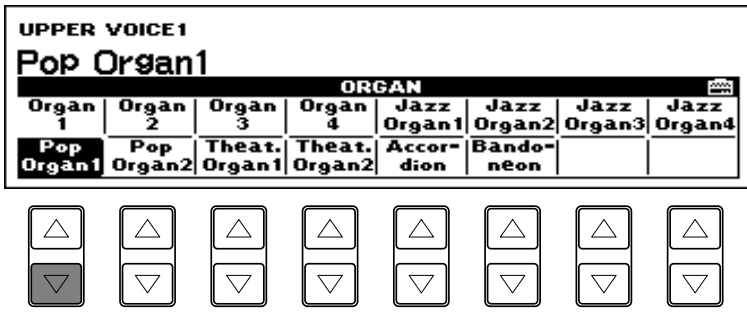

The selected voice will be shown at the upper row of the LCD. In this case, Pop Organ 1 appears.

3 If you wish to, you can select voices from the other Upper Keyboard Voice sections (Upper Voices 2 and Lead Voice), following steps #1 and #2 above.

4 Set the volume for each voice section. There are two volume controls: Coarse and Fine.

Coarse: Use the VOLUME controls of each voice section on the panel to set the desired level for each voice. The controls have seven volume settings, from a minimum of 0, or no sound, to a maximum of full volume.

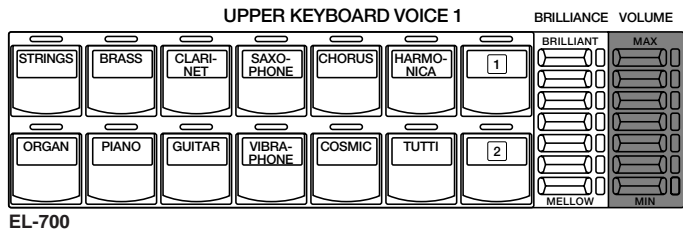

Fine: Pressing the same panel voice button again (or the same Data Control button corresponding to the selected voice) calls up the Voice Condition display. Use the Data Control buttons to the far right side to change the level of the desired voice. The relative level is indicated by the bar under each voice in the display as well as by a numeric value (from 0-24).

 NOTE:

Pressing a voice button once calls up that voice's Voice Menu display. Pressing it a second time calls up the Voice Condition display. Successive presses alternate between the two displays.

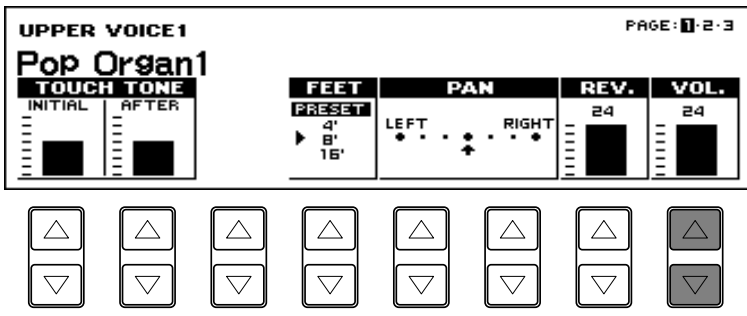



NOTE:
The Lead and Pedal Voices sound one note at a time; when you simultaneously press two or more keys, only the highest note will sound.

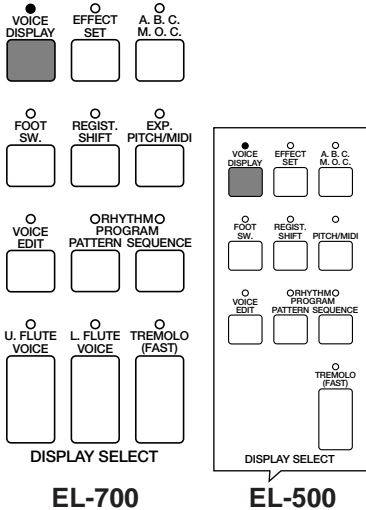

- 5** Now select voices for the Lower keyboard and Pedalboard as you did for the Upper keyboard above. Also set the volumes of the voices.
- 6** Adjust the volume balance between the Upper and Lower Voices with the Balance Control provided on the Voice Display.

- 1.** Return to the Voice Display by pressing the VOICE DISPLAY button in the DISPLAY SELECT section.
- 2.** Adjust the balance with the corresponding Data Control buttons.

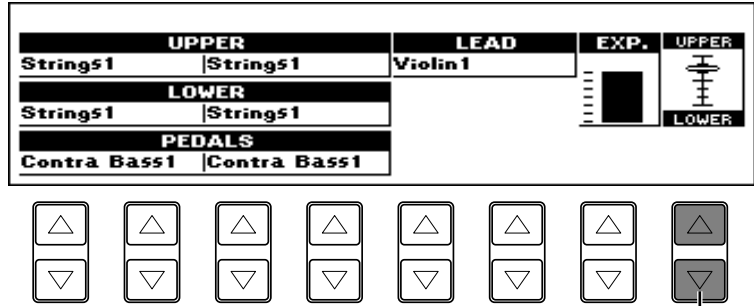

Pressing this pair of Data Control buttons at the same time restores the balance to the center position.



When the TO LOWER button is turned on, the Lead voices and Pedal voices cannot be played on the Upper keyboard and Pedalboard, respectively.

About TO LOWER - Playing (Upper) Lead Voice and Pedal Voice 1/2 from the Lower keyboard:

The Electone has a special "To Lower" function that lets you assign Lead or Bass voices to the Lower keyboard. Simply press the TO LOWER button on the voice section you wish to assign, and that voice will be playable from the Lower keyboard.

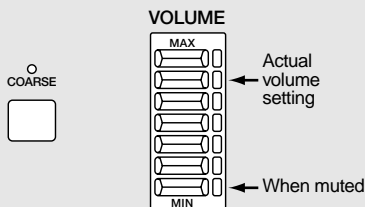
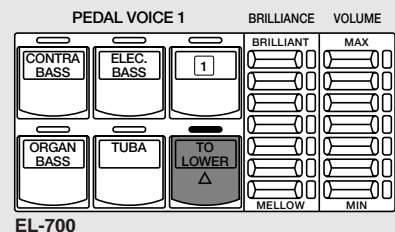
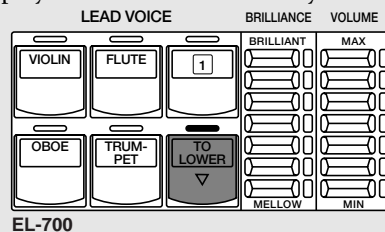

About Mute function:

The voices of the four voice sections of the Upper keyboard (two in the Lower and Pedal) sound together in a layer, and the balance of the voices in the layer is determined by these VOLUME controls. You can easily mute the voice of a voice section by holding down the COARSE button and pressing the panel volume control of the voice section you wish to mute. Repeating the procedure restores the original volume setting.



Turning the Electone off erases all panel settings you have made. When the Electone is turned on, Basic Registration 1 is automatically selected.

If you have made panel settings you wish to keep, save them to Registration Memory (see page 77) before turning the Electone off. You can, however, restore the panel settings that were made before the Electone was last turned off. See page 83 for more information.

2 Selecting Voices from the Dotted Buttons

—Dotted Buttons and User Voices—

The EL-700/500 has a wide variety of voices from which you can choose—far greater than what is immediately apparent from the front panel controls. You’ve already learned in the section above how to select the different voices that are available in the Voice Menu display of each panel voice. The Electone also has dotted buttons in each voice section, giving you access to even more voices by including space for storing and recalling voices you’ve created yourself (User voices) by using Voice Edit function (page 107). Optional Voice Disk voices containing many new voices are also being made available for the EL-700/500 (page 115).

Each voice section has one or two dotted buttons, found on the right side of each voice section. These dotted buttons function as “wild card” Voice Menu selectors; any internal or User voices can be selected from these buttons.

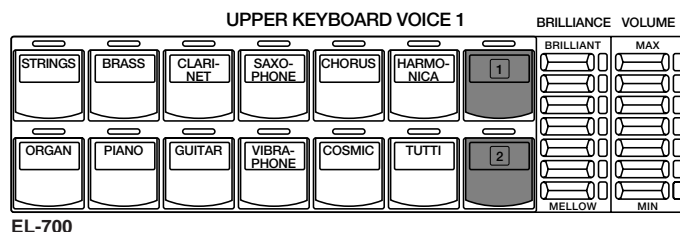

EL-700

The dotted buttons have three basic uses:

- For playing any voice of the Voice Menus from any of the keyboards or Pedalboard. You can play on the Upper keyboard, for example, voices from the twenty-two Voice Menu pages (including User), and not be limited to only the twelve buttons (equivalent to twelve Voice Menu pages) that make up the Upper Voice section. Another advantage to this feature is that when the normally monophonic (one note) Lead and Pedal voices are assigned to the Upper or Lower keyboard Voice sections, they can be played polyphonically.
- For having three different voices from the same Voice Menu page available for selection in the same song. For example, you can assign one of the voices to a dotted button in the Upper Keyboard Voice 1 section, the second voice to the other dotted button in the same section, and the third one on the Voice Menu.
- For playing the User voices of your own creation or those from a Voice Disk. (page 107)

To select voices from the dotted buttons:

1

Press one of the dotted buttons in any of the voice sections.

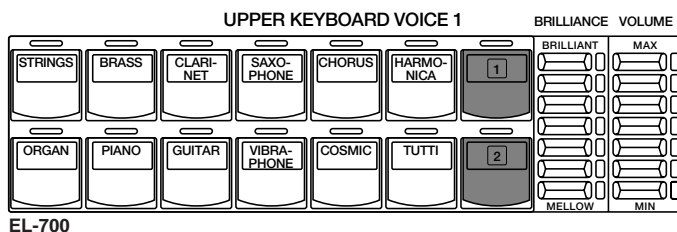

EL-700

- 2 Select one of the pages with the Page buttons, and choose a Voice Menu (PIANO, for example). Each page represents a general voice category and the title of the category appears in the dark bar in the middle of the display when the page has been selected.

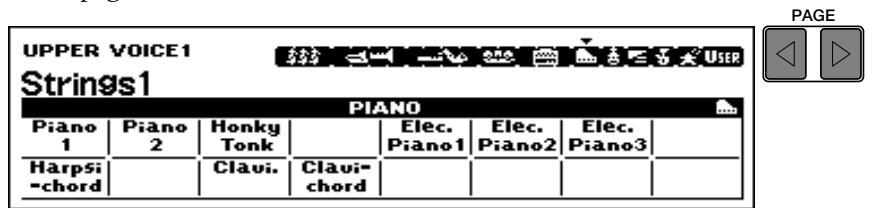

NOTE:

You can directly view and select Voice Menu pages by holding down one of the Dotted buttons and simultaneously pressing the desired voice buttons in succession.

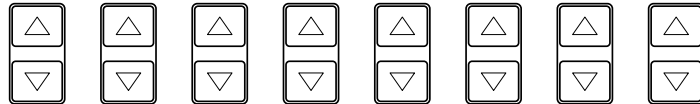

The voice name shown at the top of the LCD is that of the currently assigned voice and is irrelevant to the Voice Menu below.

- 3 Select a voice from the display (PIANO 1, for example) PIANO 1 will be shown at the top of LCD indicating that it has been selected.

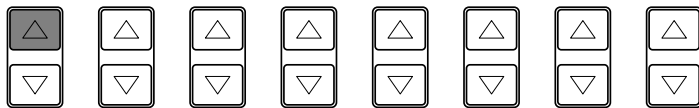
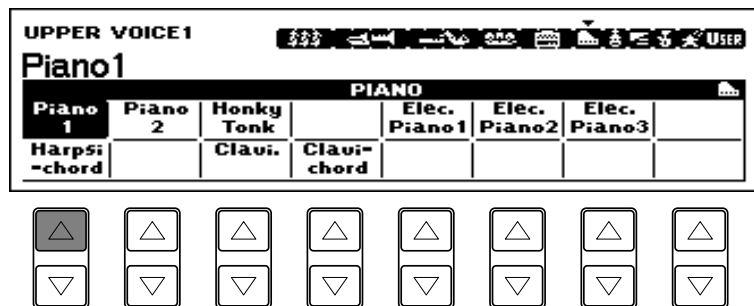

To select User voices:

Select the USER page when you wish to play voices that you've created in Voice Edit (page 107) or voices from a Voice Disk (page 115)

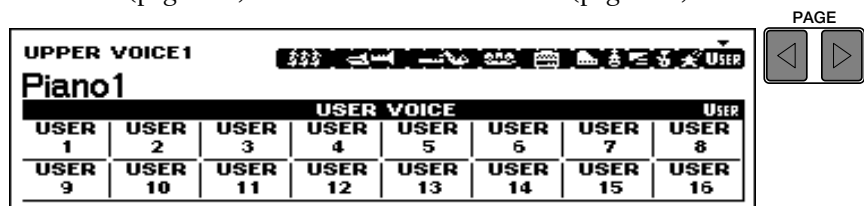

3 Voice Menus

The following chart lists the voices available and their button/page assignment.

STRINGS Upper/Lower

STRINGS							
Strings 1	Strings 2	Strings 3	Strings 4	Strings 5	Strings 6	Strings 7	
Pizz. Strings	Trem. Strings			Synth. Strs.1	Synth. Strs.2	Synth. Strs.3	

VIOLIN Lead

VIOLIN							
Violin 1	Violin 2	Violin 3	Violin 4	Violin 5	Pizz. Violin		
Cello	Kokyū						

CONTRABASS Pedal

CONTRABASS							
Contra Bass 1	Contra Bass 2	Contra Bass 3		Pizz. Bass	Uprght Bass		

BRASS Upper/Lower

BRASS							
Brass 1	Brass 2	Brass 3	Brass 4	Brass 5			
Synth. Brass 1	Synth. Brass 2	Synth. Brass 3					

HORN Lower

HORN							
Horn 1	Horn 2	Horn 3	Horn 4	Muted Horn			

TRUMPET Lead

TRUMPET							
Trumpet 1	Trumpet 2	Trumpet 3	Trumpet 4	Trumpet 5	Trumpet 6	Muted Trp.	
Trombone1	Trombone2	Muted Trb.		Flugel Horn		Euphonium	

TUBA Pedal

TUBA							
Tuba				Timpani	Timp. Roll		

FLUTE Lead

FLUTE							
Flute 1	Flute 2	Piccolo	Yokobue	Recorder	Ocarina	Pan Flute	Shakuhachi
Whistle							

OBOE Lead

OBOE							
Oboe 1	Oboe 2	English Horn		Bassoon1	Bassoon2		

CLARINET Upper/Lower

CLARINET							
Clari- net 1	Clari- net 2	Bass Cla.		Synth. Cla.1	Synth. Cla.2		

SAXOPHONE Upper/Lower

SAXOPHONE							
Saxo- phone1	Saxo- phone2	Sopra. Sax.	Sax. Ens. 1	Sax. Ens.2	Synth. Sax		
Synth. Lead1	Synth. Lead2	Synth. Lead3	Synth. Lead4	Synth. Lead5			

TUTTI Upper/Lower

TUTTI							
Tutti 1	Tutti 2	Tutti 3	Tutti 4	Tutti 5	Tutti 6	Tutti 7	

CHORUS Upper/Lower

CHORUS							
Chorus 1	Chorus 2	Chorus 3	Chorus 4	Chorus 5	Vocal		

HARMONICA Upper

HARMONICA							
Harmo- nica1	Harmo- nica2						

ORGAN Upper/Lower

ORGAN							
Organ 1	Organ 2	Organ 3	Organ 4	Jazz Organ 1	Jazz Organ 2	Jazz Organ 3	Jazz Organ 4
Pop Organ 1	Pop Organ 2	Theat. Organ 1	Theat. Organ 2	Accor- dion	Bando- neon		

ORGAN BASS Pedal

ORGAN BASS							
Organ Bass 1	Organ Bass 2	Organ Bass 3	Organ Bass 4				

PIANO Upper/Lower

PIANO							
Piano 1	Piano 2	Honky Tonk		Elec. Piano 1	Elec. Piano 2	Elec. Piano 3	
Harpsi- -chord		Clavi.	Clavi- -chord				

GUITAR Upper/Lower

GUITAR							
Guitar 1	Guitar 2	Guitar 3	12Str. Guitar	Banjo	Mando- lin	Sitar	Shami- sen
Elec. Guitar1	Elec. Guitar2	Muted Guitar	Dist. Guitar	Harp	Steel Guitar	koto	Taisho koto



VIBRAPHONE Upper/Lower

VIBRAPHONE							
Vibra- phone	Gloc- ken.	Celesta	Music Box	Marim- ba	Xylo- phone		
Chime	Synth. Chime			Steel Drum			

ELECTRIC BASS Pedal

ELECTRIC BASS							
Elec. Bass1	Elec. Bass 2	Elec. Bass 3	Elec. Bass 4	Synth. Bass1	Synth. Bass 2	Synth. Bass 3	

COSMIC Upper/Lower

COSMIC							
Cosmic 1	Cosmic 2	Cosmic 3	Cosmic 4	Cosmic 5	Cosmic 6	Cosmic 7	Cosmic 8
Cosmic 9	Cosmic 10	Cosmic 11	Cosmic 12	Cosmic 13	Cosmic 14	Cosmic 15	Cosmic 16

USER VOICE

USER VOICE							
USER 1	USER 2	USER 3	USER 4	USER 5	USER 6	USER 7	USER 8
USER 9	USER 10	USER 11	USER 12	USER 13	USER 14	USER 15	USER 16

* The details for each voices such as octave (feet) setting and effect on/off status are shown in the list on page 34.

Details on Each Voice

Page/Section	Voice Name	Preset		Comments
		Feet	Effect	
1. Upper/Lower STRINGS	Strings 1	8'	-	Large strings ensemble.
	Strings 2	8'	-	Relatively small strings ensemble for contemporary music.
	Strings 3	8'	-	Small strings ensemble.
	Strings 4	8'	-	Having specific harmonics for layering other voices.
	Strings 5	8'	-	For legato playing.
	Strings 6	8'	-	Strings with clarity. Appropriate for the fast passages.
	Strings 7	8'	-	Expressive full bodied strings with a slow attack.
	Pizz. Strings	8'	-	Pizzicato strings.
	Trem. Strings	8'	-	Tremolo strings.
	Synth. Strings 1	8'	Cele.	Synth. strings with softer attack.
	Synth. Strings 2	8'	Sym.	Bright synth. strings.
Synth. Strs. 3	8'	Cele	Softer Synth. strings.	
2. Lead VIOLIN	Violin 1	8'	-	For multi purposes.
	Violin 2	8'	-	For solo with sharp attack.
	Violin 3	8'	-	Bright fiddle for country music.
	Violin 4	8'	-	Darker synth. violin with wider dynamic range.
	Violin 5	8'	-	Violin with deep vibrato, also suited for chord playing.
	Pizz. Violin	8'	-	Pizzicato violin.
	Cello	8'	-	Cello with realistic rubbed string-instrument feel.
3. Pedal CONTRABASS	Contrabass 1	8'	-	Standard type.
	Contrabass 2	8'	-	True-to-life tight contrabass sounding in an octave unison.
	Contra Bass 3	16'	-	Realistic contrabass solo.
	Pizz. Bass	8'	-	Pizzicato contrabass for classical.
	Upright Bass	8'	-	For jazz.
4. Upper/Lower BRASS	Brass 1	8'	-	Trumpet and trombone ensemble for classical.
	Brass 2	8'	-	For big band with brighter attack.
	Brass 3	8'	-	With strong impact. Can be used as orchestra hit.
	Brass 4	U16'/L8'	-	Trombone ensemble.
	Brass 5	8'	-	Tight octave brass for contemporary music.
	Synth. Brass 1	8'	-	Synth. brass with sharp attack. Used for Basic Regist. 5.
	Synth. Brass 2	8'	-	Analog type. Can be used as melody line.
5. Lower HORN	Synth. Brass 3	8'	-	Fat synth. brass.
	Horn 1	8'	-	Standard horn for classical.
	Horn 2	8'	-	Horn unison solo. Alpenhorn.
	Horn 3	8'	-	For solo playing.
	Horn 4	8'	-	Impressive horn ensemble.
6. Lead TRUMPET	Muted Horn	8'	-	Muted horn.
	Trumpet 1	8'	-	Standard trumpet for classical.
	Trumpet 2	8'	-	Jazz trumpet 1 with full-bodied sounds.
	Trumpet 3	8'	-	Sweet voice.
	Trumpet 4	8'	-	Jazz trumpet 2 with a peculiar attack.
	Trumpet 5	8'	-	Comical synth. trumpet.
	Trumpet 6	8'	-	Resonant trumpet solo.
	Muted Trp.	8'	-	Harmon mute.
	Trombone 1	U16'/L8'	-	For legato playing.
	Trombone 2	U16'/L8'	-	Bright trombone solo. For fast phrases.
	Muted Trb.	U16'/L8'	-	Cup mute.
	Flugel Horn	8'	-	Flugelhorn.
7. Pedal TUBA	Euphonium	U16/L8	-	Euphonium with softer sounds.
	Tuba	16'	-	Accentuated by touch.
	Timpani	8'	-	Standard timpani.
8. Lead FLUTE	Timpani Roll	8'	-	Typical timpani roll.
	Flute 1	8'	-	Standard flute solo.
	Flute 2	8'	-	For legato playing.
	Piccolo	4'	-	Standard piccolo.
	Yokobue	4'	-	Japanese pipe with clear sounds.
	Recorder	4'	-	Block floete.
	Ocarina	4'	-	Ocarina with simple but warm sounds.
	Pan Flute	8'	-	Pan Flute.
	Shakuhachi	8'	-	Japanese Shakuhachi with realistic breath noises.
Whistle	4'	-	Whistle.	

* U16'/L8' indicates that the feet settings of each voice are preset to 16' on the upper keyboard and 8' on the lower keyboard.

Page/Section	Voice Name	Preset		Comments
		Feet	Effect	
9. Lead OBOE	Oboe 1	8'	-	Softer oboe.
	Oboe 2	8'	-	Rounder tone with characteristic tonguing. For fast phrases.
	English Horn	8'	-	Cor Anglais.
	Bassoon 1	U16'/L8'	-	For legato playing.
	Bassoon 2	U16'/L8'	-	For staccato playing.
10. Upper/Lower CLARINET	Clarinet 1	8'	-	Standard clarinet.
	Clarinet 2	8'	-	Clarinet solo for jazz and contemporary.
	Bass Cla.	8'	-	Bass clarinet with fat and resonant sounds.
	Synth. Cla. 1	8'	-	Resonant synth. clarinet.
	Synth. Cla. 2	8'	-	Synth. reed with a unique attack sound.
11. Upper/Lower SAXOPHONE	Saxophone 1	U16'/L8'	-	Alto sax.
	Saxophone 2	U16'/L8'	-	Characteristic tenor sax with strong tonguing.
	Sopra. Sax.	8'	-	Standard soprano sax.
	Sax. Ensem. 1	U16'/L8'	-	Softer sounds for classical.
	Sax. Ens. 2	U16'/L8'	-	Saxophone section for bigband.
	Synth. Sax.	8'	-	Wind synthesizer with thick sounds in the middle and lower range.
	Synth. Lead 1	8'	-	Softer analog synth. reed.
	Synth. Lead 2	8'	-	Clear synth. reed with a sharp attack.
	Synth. Lead 3	4'	-	Hoarse noise reed.
	Synth. Lead 4	8'	-	Digital synth. reed.
Synth. Lead 5	8'	-	Synth. reed with thick fourth notes.	
12. Upper/Lower TUTTI	Tutti 1	8'	-	Strings unison and wood winds ensemble.
	Tutti 2	8'	-	Strings unison and the brasses.
	Tutti 3	8'	-	The brasses for classical and bands.
	Tutti 4	8'	-	Big band. Softer playing = sax only. Harder playing = 1 octave higher brasses added.
	Tutti 5	8'	-	Wood winds ensemble. Instruments vary depending on the register played.
	Tutti 6	8'	-	Wood winds quintet.
	Tutti 7	8'	-	Brass ensemble.
13. Upper/Lower CHORUS	Chorus 1	8'	-	Female "Ah".
	Chorus 2	8'	-	Male "Wh".
	Chorus 3	8'	-	Mixed chorus.
	Chorus 4	8'	-	Mixed chorus with beautiful resonance. Wh.
	Chorus 5	8'	-	Scat type vocal ensemble.
	Vocal	8'	-	Accentuated solo vocal, "Ah".
14. Upper HARMONICA	Harmonica 1	8'	-	Standard type with pitch modulated vibrato.
	Harmonica 2	8'	-	Solo harmonica with filter and amplitude modulated vibrato.
15. Upper/Lower ORGAN	Organ 1	8'	-	Small pipe organ. 8'.
	Organ 2	8'	-	Big pipe organ with full coupler.
	Organ 3	8'	-	Nasard stops. 8'+2 2/3'.
	Organ 4	8'	-	Harmonium.
	Jazz Organ 1	16'	Chor.	For solo playing. 16'+8'+5 1/3'.
	Jazz Organ 2	16'	Trem.	16'+8'+2'.
	Jazz Organ 3	16'	Trem.	For cluster playing. 16'+1 3/5+1 1/3'+1'.
	Jazz Organ 4	16'	Chor.	Fat and noisy jazz organ.
	Pop Organ 1	8'	Chor.	Bright sounds for jazz. 8'+4'+2 2/3'.
	Pop Organ 2	8'	Chor.	For multi purposes.
	Theat. Organ 1	8'	Sym.	8'+4' with slower attack.
	Theat. Organ 2	8'	-	16'+8' with slower attack.
	Accordion	8'	-	Slower attack.
	Bandoneon	8'	-	Attack can be controlled by initial touch.
16. Pedal ORGAN BASS	Organ Bass 1	8'	-	Combination organ bass.
	Organ Bass 2	16'	-	Pipe organ bass 1. Standard type.
	Organ Bass 3	16'	-	For jazz. 16'.
	Organ Bass 4	16'	-	Pipe organ bass 2. Full coupler.
17. Upper/Lower PIANO	Piano 1	8'	-	For multi purposes.
	Piano 2	8'	-	Brighter sounds. CP80 type.
	Honkytonk	8'	-	Honky tonk piano.
	Elec. Piano 1	8'	Cele.	DX7 type.
	Elec. Piano 2	8'	Cele.	Old fashioned, full bodied electric piano.
	Elec. Piano 3	8'	-	Electric piano with clearly brilliant but deep sounds.
	Harpsichord	8'	-	Standard cembalo.
	Clavi.	16'	-	Funky clavi.
Clavichord	8'	-	Clavichord with stable and grave sounds.	

Page/Section	Voice Name	Preset		Comments
		Feet	Effect	
18. Upper/Lower GUITAR	Guitar 1	U16'/L8'	-	Folk guitar. Steel string.
	Guitar 2	U16'/L8'	-	Acoustic jazz guitar. Tone varies depending on the touch.
	Guitar 3	U16'/L8'	-	Classic guitar. Suitable to backing for bossanova.
	12Str. Guitar	U16'/L8'	-	12-string classic guitar with gorgeous sounds.
	Banjo	8'	-	For country and dixieland.
	Mandolin	8'	Cele.	Standard mandolin.
	Sitar	8'	-	Indian sitar with the different resonances between lower and mid./high ranges.
	Shamisen	8'	-	Japanese classical shamisen.
	Elec. Guitar 1	U16'/L8'	-	For backing.
	Elec. Guitar 2	U16'/L8'	-	For solo playing.
	Muted Guitar	U16'/L8'	-	Muted guitar.
	Dist. Guitar	U16'/L8'	-	Distorted guitar.
	Harp	8'	-	Grand harp.
	Steel Guitar	8'	-	Hawaiian guitar. Effective when used with the glide function.
Koto	8'	-	Japanese Koto.	
Taisho Koto	4'	Cele.	Japanese Taisho Koto.	
19. Upper/Lower VIBRAPHONE	Vibraphone	8'	-	Standard vibraphone.
	Glocken	4'	-	Glockenspiel.
	Celesta	4'	-	Celesta.
	Music Box	4'	-	Antique music box.
	Marimba	8'	-	Concert marimba.
	Xylophone	4'	-	Tone varies depending on the initial touch.
	Chime	4'	-	Chime.
	Synth. Chime	8'	Cele.	Starry chime.
Steel Drum	8'	-	Steel Drum.	
20. Pedal ELECTRIC BASS	Elec. Bass 1	8'	-	For multi purposes.
	Elec. Bass 2	16'	-	Slap bass.
	Elec. Bass 3	16'	-	Plucked bass with hard attack.
	Elec. Bass 4	16'	Cele.	Fretless bass, also suited for solo playing.
	Synth. Bass 1	16'	-	Sustained sounds.
	Synth. Bass 2	16'	-	With remarkable attack.
Synth. Bass 3	16'	-	Tone varies depending on the touch.	
21. Upper/Lower COSMIC	Cosmic 1	4'	-	Decay type. For multi purposes. UK in Basic Regist. 4.
	Cosmic 2	8'	-	The lower register of celesta. LK and PK in Basic Regist. 4.
	Cosmic 3	8'	-	Brass type.LK in Basic Regist. 5.
	Cosmic 4	8'	-	Decay type. With fantastic image.
	Cosmic 5	8'	-	Spacious sounds with feedback.
	Cosmic 6	8'	-	Synth. brass type.
	Cosmic 7	8'	-	Vocal type with feedback.
	Cosmic 8	8'	-	Distortion type with feedback.
	Cosmic 9	8'	-	Decay type with unique feedback.
	Cosmic 10	8'	-	Clear synth. pad.
	Cosmic 11	8'	-	Digital synth. pad.
	Cosmic 12	8'	-	Chorus type synth. pad.
	Cosmic 13	8'	-	Special sound effect with a slower attack. The sounds drastically changes.
	Cosmic 14	8'	-	Fantastic digital music box.
	Cosmic 15	8'	-	Ethnic synth. percussion.
	Cosmic 16	16'	-	Special sound effect with a complicated mixture of various sounds.

The Flute Voice feature allows you to create your own organ voices, giving you access to an unlimited combination of organ sounds. With this function, you can recreate all of the classic organ sounds by adjusting the flute footage levels and the percussive sounds, just like on conventional organs. There are eight flute footage settings, with three additional footage settings for the attack sound. You can select various Preset Flute Voices, or create your own and save those to User Voices. There are five pages: Menu, Footage, Attack, Volume, Save.

1 Creating Flute Voices

To create the Flute Voices:

- 1 Press one of the Flute Voice buttons (UPPER or LOWER) in the DISPLAY SELECT section.

The FOOTAGE page appears on the LCD and the LED above the button lights.

FOOTAGE

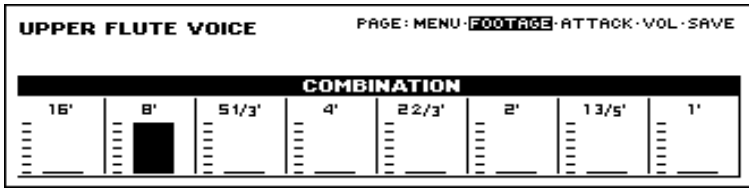

- 2 Use the Data Control buttons directly under the flute footage numbers to change each footage volume.

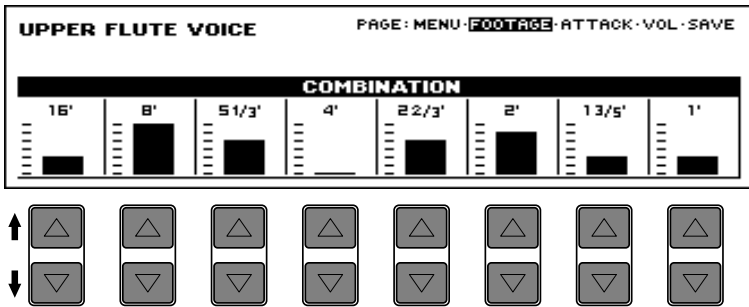

Play the keyboard and listen to the changes in the sound as you adjust the footage volumes.

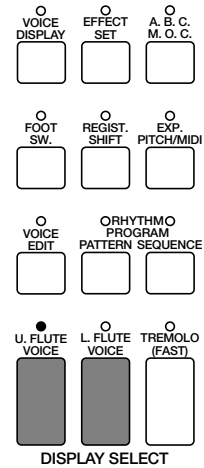

EL-700



NOTE:

Pressing the button again turns the Flute Voice function off (the LED also turns off), and changes the LCD to the Voice Display. Each of the buttons acts as an on/off switch.



NOTE:

The total volume of the all footages are set on the VOL. page below.

3 Press the Page buttons to select the various pages for the other Flute Voice functions.

ATTACK Page

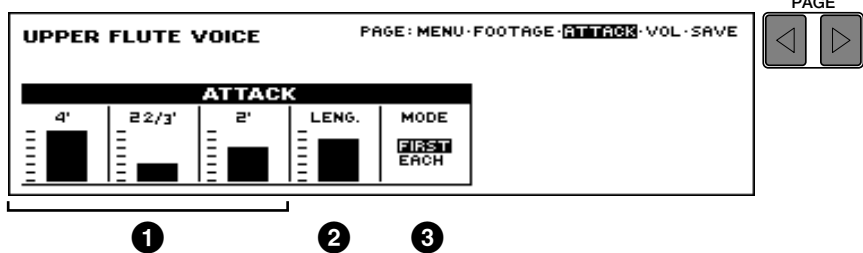

- 1 Attack Footages**
Determines the level of each volume in the percussive portion of the voice. Footage settings are 4', 2-2/3' and 2'.
- 2 Attack Length**
Determines the duration of the attack sound.
- 3 Mode**
Determines which notes in a held group of notes are given an attack sound.
 - **FIRST:** Only the first note played will have attack; all other notes played while the first is held have no attack.
 - **EACH:** All notes played have an attack sound.



NOTE:

“Mode” is common to both Upper and Lower Flute Voices.

VOLUME Page



- 1 Click**
Determines the volume of the key click sound. Click is independent of the Attack sound described above.
- 2 Response**
Determines the overall response speed of the sound. Lower settings make the keyboard response faster; higher settings result in a slower response, creating a pipe organ effect.
- 3 Tremolo**
Turns the Tremolo effect for the Flute Voice on or off. This is the primary on/off switch for the Tremolo/Chorus effect. After this has been set to ON, you can turn the effect on and off during your performance by using the TREMOLO (FAST) button in the DISPLAY SELECT section. (See the Tremolo section, page 56 for more information.)
- 4 Reverb**
Determines the amount of reverb applied to the Flute Voice voice.
Range: 0-24
- 5 Volume**
Determines the overall volume of the Flute Voice voice.
Range: 0-24



NOTE:

No reverb can be obtained even though you raise the level here, unless you raise the total reverb level using the panel Reverb buttons (page 49).



NOTE:

If the Volume is set to 0, no sound will be produced.

2 Save to User Flute Voice

Saves the currently created Flute Voice to the selected User Flute Voice memory space.

After you have created a Flute Voice with the Flute, Attack and Volume pages, you can save that Flute Voice.

To save your own Flute Voice:

1 Press the Page buttons to select the SAVE page.

SAVE Page

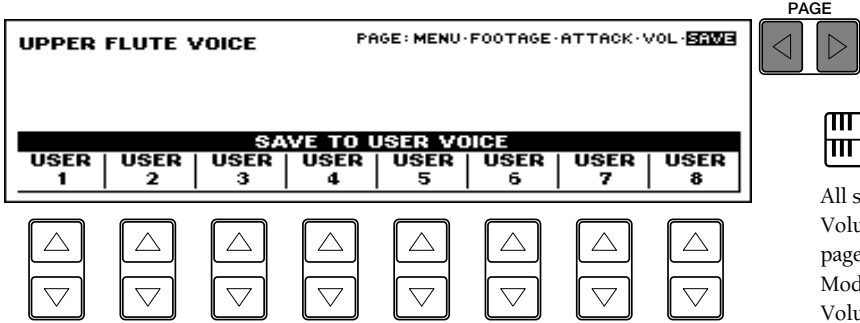

NOTE:

All settings in the Footage, Attack and Volume pages can be saved to the Save page, except for the following: Attack Mode, Tremolo On/Off, Reverb and Volume.

2 Select the desired user voice number (USER 1 through 8) to which the new voice will be saved. Pressing the appropriate Data Control button saves your new Flute Voice to that memory space and erases any voice that had been previously saved there. When the operation has been completed, the selected User number in the display will momentarily flash. User voices 1 through 8 correspond to those shown in the Menu page below.

3 Using Preset and User Voices

To call up the Preset Voices and User Voices:

1 Press the Page buttons to select the MENU page.

MENU Page

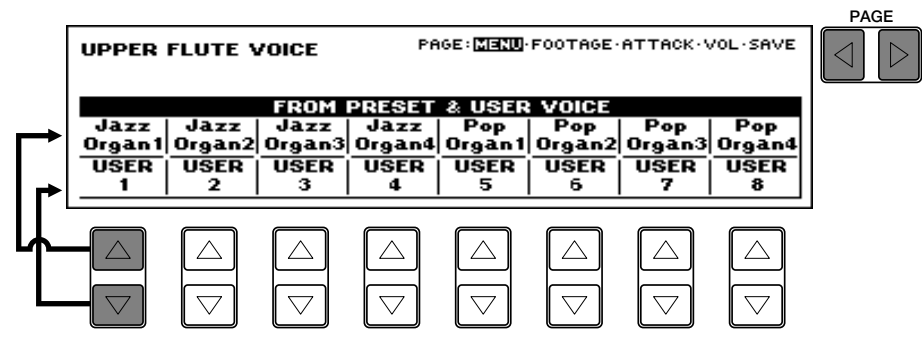

2 Select Preset or User Flute Voices.
 Eight factory-preset voices (four Jazz Organ and four Pop Organ voices) are set to the upper row, and the eight User voices in the bottom row are for selecting voices you created and stored with the SAVE page.



NOTE:

The User area described in this section has no relation to that of the Voice Menu page.



NOTE:

When you use the Upper/Lower Flute Voices and/or other voices at the same time, only one of the voices can be displayed at a time, even though all voices may be operative and both of the Upper and Lower Flute Voice LEDs are lit.



NOTE:

Remember that the UPPER and LOWER FLUTE VOICE buttons are on/off switches. In the process of turning on a Flute Voice, then switching to another function and returning to the Flute Voice, you may unintentionally turn the Flute Voice off. Check whether the Flute Voice LEDs are on or off before you start to play.

The Electone is equipped with two general kinds of functions that can be used to change the sound of the voices: Voice Controls and Effects.

Voice controls are used to change various aspects of the voices, such as the touch sensitivity, volume, octave (footage), vibrato, pan setting and brilliance. The voice controls, as well as the selection of certain effects, are provided in the Voice Condition pages, described below.

Effects are an extremely versatile set of tools through which you can enhance the sound of the voices. They include: Reverb, Sustain, Tremolo, Symphonic, Delay, Flanger and Distortion. Effect settings are controlled from the Reverb, Sustain, Tremolo and Effect Set pages.

Each voice has been given certain factory-preset effect settings to best enhance its sound. However, if you wish, you can change the sound to suit your preferences by using the controls described in this section.

The chart below shows the various voice controls and effects for the individual voice sections. Available functions are indicated by circles.

		Touch Tone (Initial/ After)	Feet	Pan	Brilliance *1	Sym- phonic/ Celeste	Delay	Flanger	Distortion	Vibrato	Lead Slide	Lead Tune	Reverb *2	Sustain	Tremolo /Chorus *3
Upper	Upper Keyboard Voice 1	○	○	○	○	○	○	○	○	○			○	○	○
	Upper Keyboard Voice 2	○	○	○	○	○	○	○	○	○			○	○	○
Lower	Lower Keyboard Voice 1	○	○	○	○	○	○	○	○	○	—	—	○	○	○
	Lower Keyboard Voice 2	○	○	○	○	○	○	○	○	○			○	○	○
Lead	Lead Voice	○	○	○	○	○	○	○	○	○	○	○	○	—	○
Pedal	Pedal Voice 1	○	○	○	○	○	○	○	○	○	—	—	○	○	○
	Pedal Voice 2	○	○	○	○	○	○	○	○	○			○	○	○
Related Pages	Voice Condition Page 1	○	○	○	—	—	—	—	—	—	—	—	○	—	—
	Voice Condition Page 2 *4				○	○	○	○	○	—	—	—	—	—	○
	Voice Condition Page 3					—	—	—	—	○	○	○	—	—	—
	Effect Set Page *4					○	○	○	○				—	—	○
	Reverb Page	—	—	—									○		
	Sustain Page													○	
	Tremolo Page													—	○

*1 Although no Brilliance buttons are provided on the EL-500's front panel, the Brilliance values can be adjusted in the Voice Condition page 2 (page 44).

*2 The total reverb depth and length are controlled on the reverb page 1, though the different reverb settings can be done for each voice section.

*3 Turning tremolo/chorus on/off and switching between tremolo and chorus are common to all voice sections.

*4 The contents of the Voice Condition Page 2 and Effect Set Page are the same except for the Brilliance setting.

To change the settings and add the effects, display the appropriate page:

- Voice Condition page by pressing the panel voice button twice (or pressing the Data Control button corresponding to the selected voice).
- Effect Set page by pressing the EFFECT SET button in the DISPLAY SELECT.
- Reverb, Sustain or Tremolo page by pressing the corresponding panel button.



NOTE:

Sustain, Reverb and Tremolo/Chorus can be set for the Upper/Lower Flute Voices (EL-700 only).

1 Selecting from Voice Condition Pages

To call up the Voice Condition page:

Choose a voice on the panel, then press that voice's panel button again (or again press the Data Control button corresponding to the selected voice).

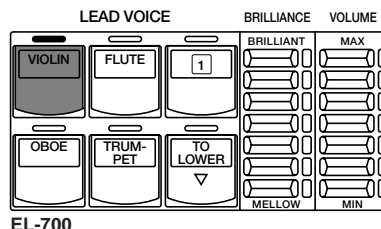

EL-700

The Voice Condition display pages of the various voice sections have slight differences in their functions.

Each function in the Voice Condition page is independently applied to each voice section.

Voice Condition [PAGE 1]

Upper/Lower

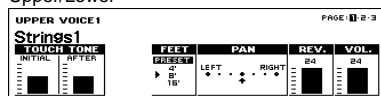

Pedal

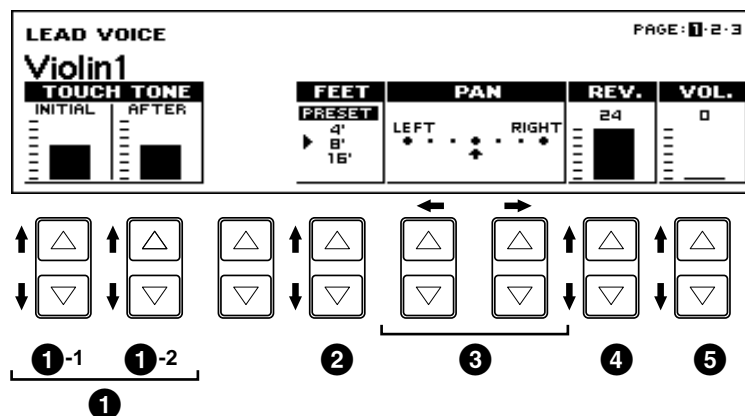
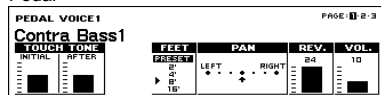

1 TOUCH TONE

The Touch Tone function gives you expressive control over the volume and timbre of a voice. Two types of keyboard touch affect this function: Initial Touch and After Touch.

All voices are provided with this expressive function, making it possible to perfectly reproduce the subtle dynamic and tonal changes of actual instruments. For example, piano voices sound much brighter when you hit the keys strongly, especially in the attack portion of the sound — exactly as if you were playing an acoustic piano.

1-1 INITIAL Touch

Controls volume and timbre according to the velocity at which you strike the keys. The harder you strike the keys, the greater the volume and the brighter the timbre will become.

1-2 AFTER Touch

Controls volume and timbre according to the pressure you apply to the keys after playing them. The harder, you press down on the keys, the greater the volume and the brighter the timbre will become.



NOTE:

Generally, After Touch has no effect on percussive voices (such as Piano, Harpsichord or Vibraphone) or percussion sounds.



NOTE:

Minimum setting produces no effect at all.



NOTE:

In the case of the EL-500 the Touch Tone (Initial/After) value of the Pedal Voice section is grayed out and is not accessible. However, the value can be controlled from the MDR or an external device through MIDI.

2 FEET

Determines the octave setting of the voice. PRESET is the original (factory) setting; 4' is the highest and 16' is the lowest. 2' setting is added to the Pedal Voice sections.

3 PAN

Determines the position of the voice in the stereo image. Seven pan positions are available.

4 REV. (REVERB)

Determines the amount of reverb applied to each Voice section.
Range: 0-24



NOTE:

No reverb can be obtained even though you raise the level here, unless you raise the total reverb level using the panel Reverb buttons (page 49).

5 VOL. (VOLUME)

Fine adjustment of the voice volume. See page 27 for more information.

Voice Condition [PAGE 2]

Press the Page buttons to select PAGE 2.

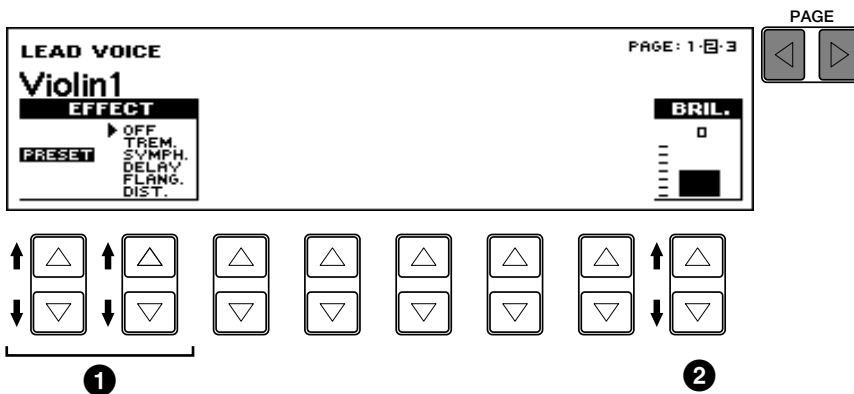

1 EFFECT

Determines the effect type applied to each voice section. The settings and adjustments for the effects are also made from the Effect Set pages. (For more information, see page 45.)

- 1-1 **PRESET:**
Selects the original (factory) effect.
- 1-2 **OFF:**
Cancels the effect.
- 1-3 **TREM. (TREMOLO):**
Selects Tremolo/ Chorus. See page 54 for the details of the Tremolo/ Chorus setting.

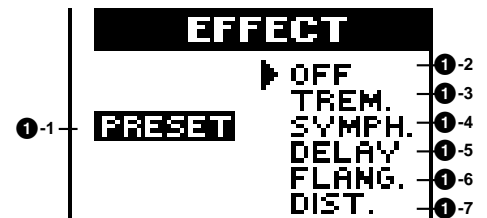

- 1-4 SYMPH. (SYMPHONIC):**
Selects Symphonic/ Celeste. See page 46 for the details of the Symphonic/ Celeste setting.
- 1-5 DELAY:**
Selects Delay. See page 46 for the details of the Delay setting.
- 1-6 FLANG. (FLANGER):**
Selects Flanger. See page 47 for the details of the Flanger setting.
- 1-7 DIST. (DISTORTION):**
Selects Distortion. See page 48 for the details of the Distortion setting.

2 BRIL. (BRILLIANCE)

Adjustment of the voice tone. Higher settings make the voice brighter. (This control is the same as on the EL-700's front panel.)

Range: -3- +3

Voice Condition [PAGE 3]

Press the Page buttons to select PAGE 3.

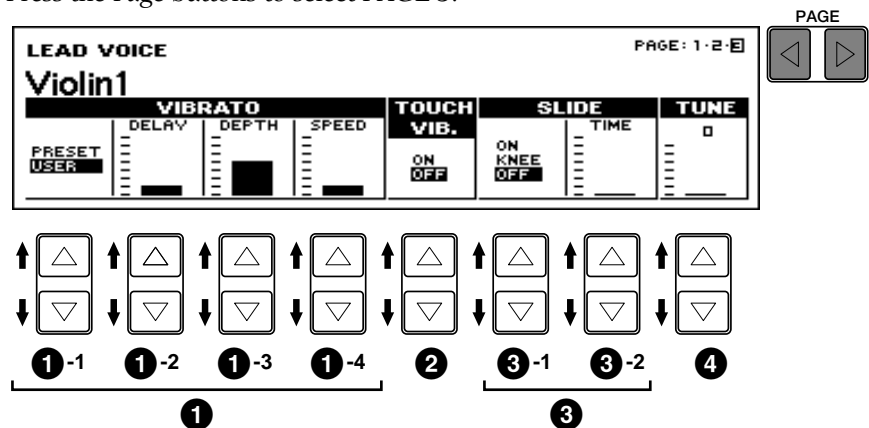

Upper/Lower/Pedal

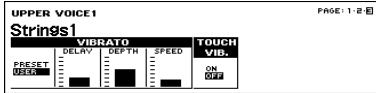

The Lead Slide and Lead Tune functions are only available with the Lead Voice section.



NOTE:

The User vibrato may not be effective for some voices such as Harmonica2, Electric Piano1 and Synth. Chime.



NOTE:

The Delay, Depth and Speed settings are not displayed and cannot be adjusted unless USER has been selected in this setting.

1 VIBRATO

- 1-1 PRESET/USER**
Selects Preset, which calls up the original (factory) vibrato settings for the voice, or User, which lets you adjust the vibrato settings yourself.

1-2 DELAY

Determines the amount of time that elapses between the playing of a key and the start of the vibrato effect (see diagram). Higher settings increase the delay of the vibrato onset.

1-3 DEPTH

Determines the intensity of the vibrato effect (see diagram). Higher settings result in a more pronounced vibrato.

1-4 SPEED

Determines the speed of the vibrato effect (see diagram).

Vibrato Control

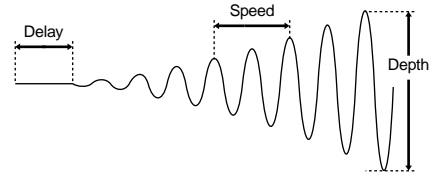

NOTE:

When you set the DEPTH to 0, the Vibrato function will be inactive.



NOTE:

In the case of the EL-500 the Touch Vibrato value of the Pedal Voice section is grayed out and is not accessible. However, the value can be controlled from the MDR or an external device through MIDI.

2 TOUCH VIB. (TOUCH VIBRATO)

On/Off switch for the Touch Vibrato function.

Touch Vibrato lets you apply vibrato to individual notes as you play them. While playing a key, press down harder on it to give the note vibrato. The harder you press the key down, the greater the vibrato will be.

3 SLIDE (Lead voices only)

Slide applies a portamento effect to notes played in legato. For example, if you play one note, then play another before completely releasing the first note, the pitch of the first note will “slide” up or down to the second note. The Slide function is effective within a one-octave range.

3-1 ON/KNEE/OFF

On/Off switch and knee lever selector for the Slide effect.

3-2 TIME

Determines the speed of the slide or portamento effect. The higher the value that is set, the slower the speed.

4 TUNE (Lead voices only)

Determines the pitch of the Lead voice. This control lets you detune the Lead voice relative to the other voices of the Electone, for producing a richer sound. The higher the value set, the higher the pitch. Range: 0-24 (max. 28.88 cents; 1 step= Ca.1.2cents)



NOTE:

You can select the voice section to which the effect should be applied, by pressing the Page buttons.

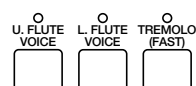
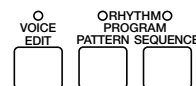
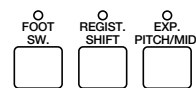
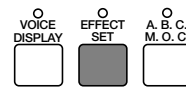

DISPLAY SELECT

EL-700

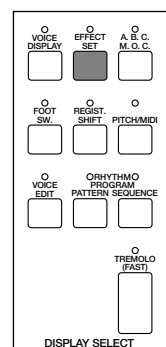

EL-500

2 Selecting from Effect Set Pages

Pressing the EFFECT SET button in the DISPLAY SELECT section calls up the Effect Set pages. The page contents are the same as the ones from the Voice Condition Page 2 except for the Brilliance. See page 43 for the functions of the PRESET and OFF.

Effect Set Page

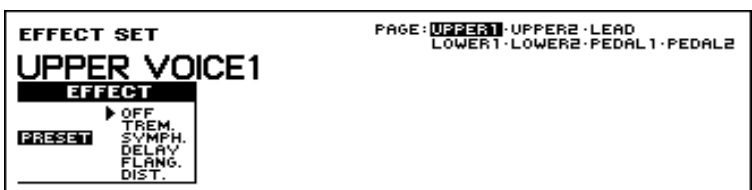

1 TREM./CHOR. (TREMOLO/CHORUS)

See Tremolo section on page 53. Independently applied to each voice section.

2 SYMP. (SYMPHONIC/CELESTE)

Determines the type of the Symphonic effect, SYMPHONIC (SYMP.) or CELESTE (CELE.). Symphonic is a subtle echo effect that makes one voice sound like an ensemble. For example, a solo violin voice played through Symphonic would sound like many violins playing together. SYMPHONIC simulates the effect of a large ensemble, while CELESTE creates the effect of a gradually expanding sound. Independently applied to each voice section.

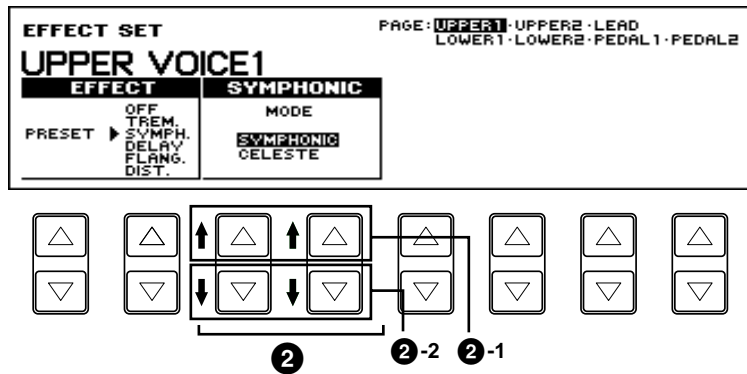

2-1 SYMPHONIC

Selects the Symphonic effect to the designated voice section.

2-2 CELESTE

Selects the Celeste effect to the designated voice section.

3 DELAY

Delay is a pronounced echo effect, with distinct delayed repeats of the original sound. Independently applied to each voice section.

Delay Effect

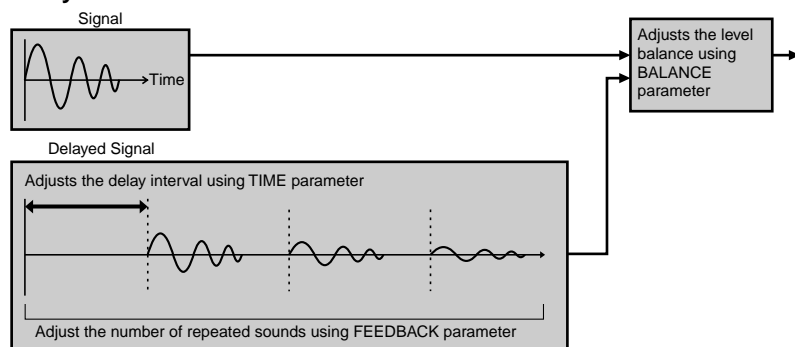

EFFECT SET PAGE: UPPER1 · UPPER2 · LEAD
LOWER1 · LOWER2 · PEDAL1 · PEDAL2

UPPER VOICE1

EFFECT		DELAY			
PRESET	OFF TREM. SYMPH. DELAY FLANG. DIST.	TIME 242ms	F.B. 28.5%	BAL. 60.6%	MODE MONO ST.1 ST.2 ST.3

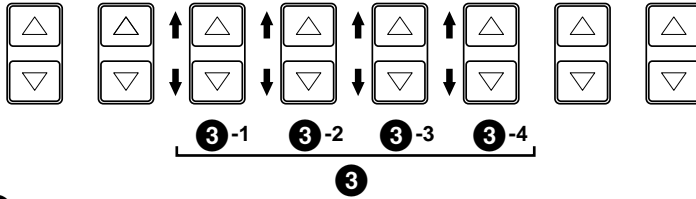

- 3-1 TIME**
Determines the time between delayed repeats. Range: 5ms - 956ms
- 3-2 F.B. (Feedback)**
Determines the number of delayed repeats. Range: 0.2% - 46.9%
- 3-3 BAL. (Balance)**
Determines the volume of the delay effect, relative to the original sound. Higher settings produce a louder delay. Range: 0% - 100%
- 3-4 MODE**
Selects the delay type from Mono, ST (Stereo) 1, 2, 3.
Selecting one of the Stereo Delays produces more expanding image or an image sounds move from right to left (or left to right).
Range: MONO, ST.1, ST.2, ST.3

Characteristics of Each Stereo Type

- ST.1: produces the most complicated reflections.
- ST.2: repeats the periodical movements in the following order:
center → right → left.
- ST.3: adds thickness and brilliance to the mono delay.

4 FLANGER

Flanger introduces a swirling, animated modulation effect to the sound. Independently applied to each voice section.

Flanger Effect

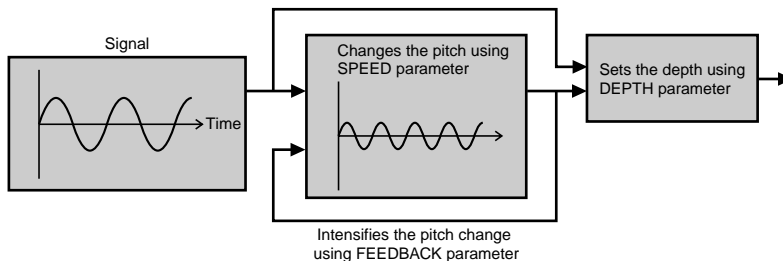

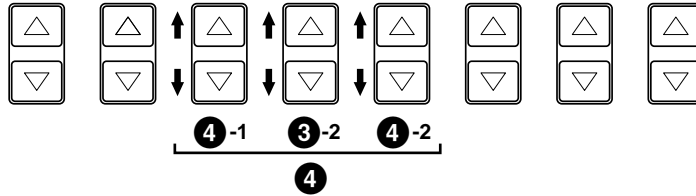
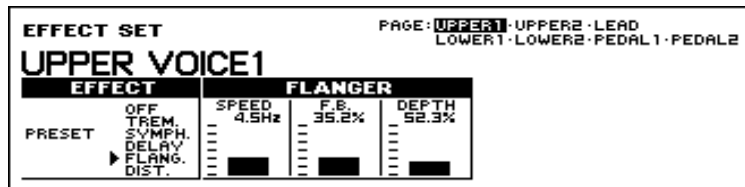

4-1 SPEED

Determines the speed of the modulation. Range: 0Hz - 12.1Hz

4-2 F.B. (Feedback)

Controls the brightness and the metallic sound of the effect.
Range: 0.6% - 94.0%

4-3 DEPTH

Determines the intensity of the effect. Range: 37.8% - 87.8%

5 DISTORTION

Distortion adds a distorted image to the sounds usually found in electric guitars. Independently applied to each voice section.

Distortion Effect

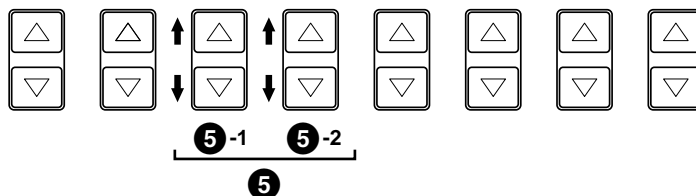
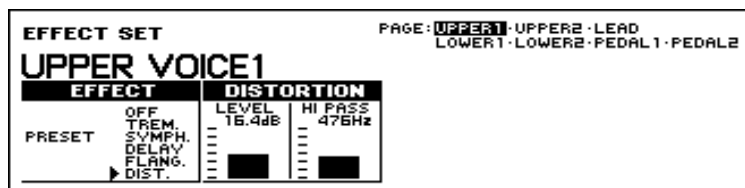
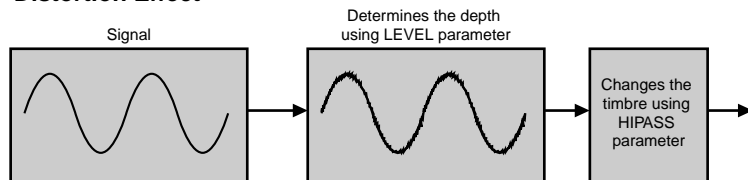

5-1 LEVEL

Determines the depth of the distorted sounds.
Range: 0dB - 21.8dB

5-2 HI PASS

Changes the timbre of the distorted sounds.
Range: 20Hz - 1036Hz

3 Selecting from the Panel

Reverb, Sustain and Tremolo/Chorus pages are called up by pressing the respective panel buttons.

1) Reverb

Reverb adds an echo-like effect to the sound, giving the impression of a performance in a large room or concert hall. The effect can be applied equally and simultaneously to all voices, or set individually for each voice section of the Electone, even independently for rhythm and accompaniment.

To adjust the reverb effect and call up the Reverb pages:

Press one of the REVERB buttons, located to the left of the Upper Keyboard Voices section.

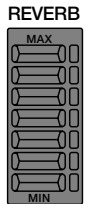

REVERB Page 1

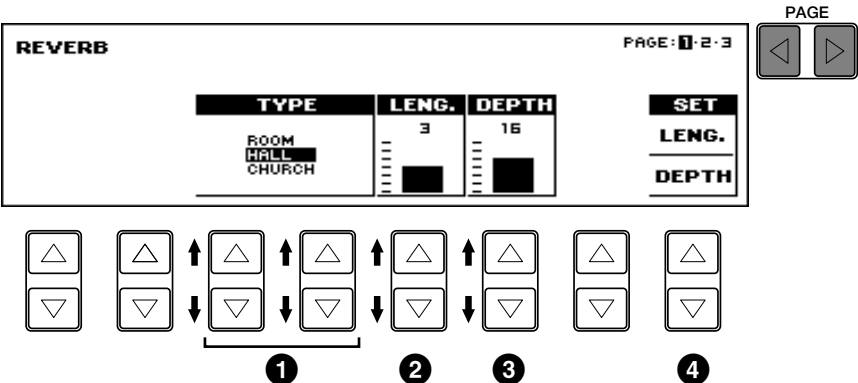

- 1 TYPE**
Determines the type of reverb effect: Room, Hall or Church. Each type simulates a different acoustic environment; Room is the smallest and Church the largest.
- 2 LENG. (Length)**
Determines the acoustic liveliness of the simulated room in the effect. Higher settings make the room more reverberant.
Range: 0-6
- 3 DEPTH**
Fine adjustment of the depth of reverberation or the level of the reflected sounds. (Coarse reverb depth settings are made with the front panel REVERB controls.) A setting of 0 cancels the reverb effect. Range: 0-24
- 4 SET**
Uniforms the Length and Depth settings set for all registrations to the currently displayed values on the LCD.



NOTE:

When this parameter or the panel REVERB control is set to the minimum, the settings in the pages that follow have no effect.

Selecting LENG. (LENGTH) will display the following message.

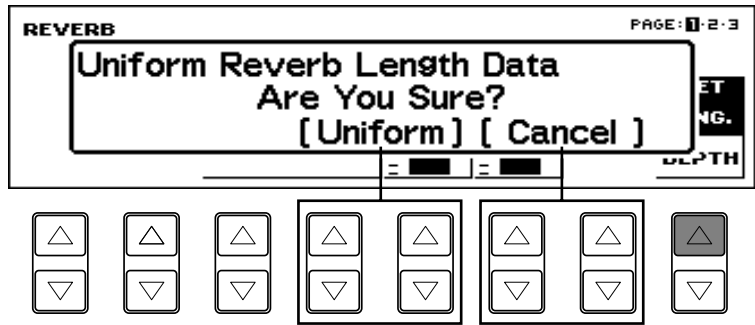

NOTE:

In the case of EL-500 equipped with 8 Registration Memories (page 77), from 1 through 8, executing the operation (uniforming Length/Depth) equally affects the Registration Memories 9 through 16, too. This function is useful when you edit the data created with the upper models such as EL-700 and EL-900.

Select [Uniform] to set the current Length value for all registrations in the 16 Registration Memories. Select [Cancel] to abort the operation.

Selecting DEPTH will display the following message.

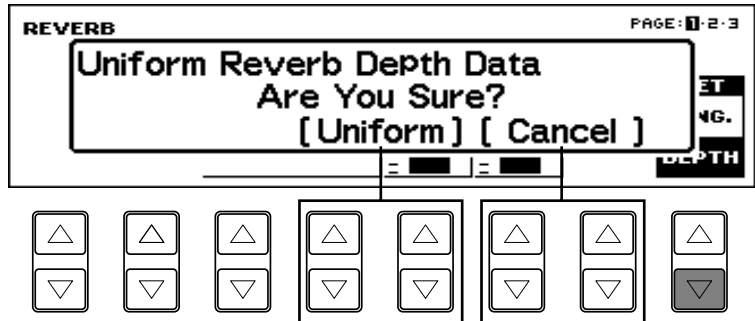

Select [Uniform] to set the current Depth value for all registrations in the 16 Registration Memories. Select [Cancel] to abort the operation.

REVERB Page 2

Determines the amount of Reverb effect applied to each voice section. Each parameter corresponds to REV. (REVERB) in the Voice Condition page 1.

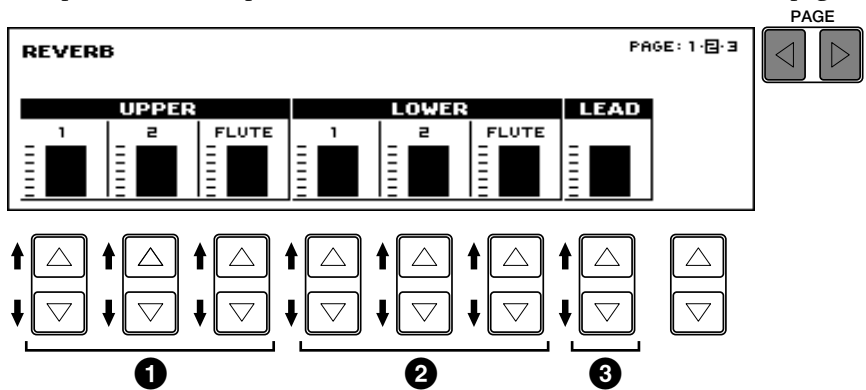

EL-700

1 UPPER 1, 2, FLUTE (EL-700 only) Sections

Determines the amount of reverb applied to each voice section.

Range: 0-24

2 LOWER 1, 2, FLUTE (EL-700 only) Sections

Determines the amount of reverb applied to each voice section.

Range: 0-24

3 LEAD Section

Determines the amount of reverb applied to the Lead Voice section.

Range: 0-24

REVERB Page 3

Determines the amount of Reverb effect independently applied to Pedal Voice sections, Rhythm section and Accompaniment.

Each parameter corresponds to REV. (REVERB) in the respective Condition pages.

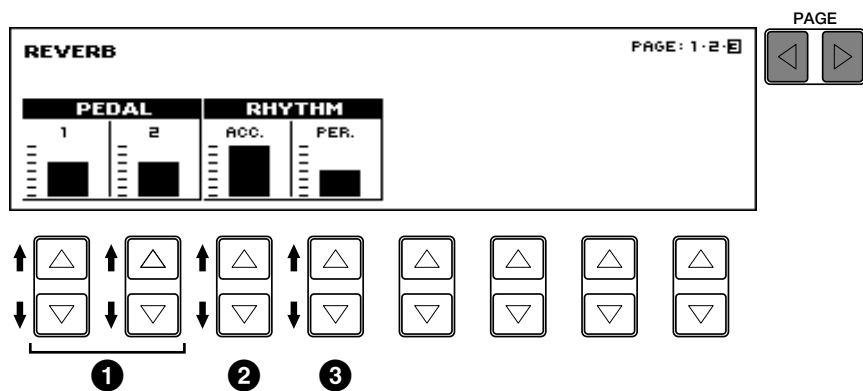

1 PEDAL 1, 2 Sections

Determines the amount of reverb applied to the Pedal Voice sections.

Range: 0-24

2 RHYTHM ACC. (Accompaniment)

Determines the amount of reverb applied to the Accompaniment (mentioned on page 67).

Range: 0-24

3 RHYTHM PER. (Percussion)

Determines the amount of reverb applied to the rhythm pattern percussion sounds (mentioned on page 59).

Range: 0-24



NOTE:

Sustain cannot be applied to the Lead voices.



NOTE:

If Knee Lever control of the Upper or Lower sustain has been turned on (folded down), pressing the Upper or Lower buttons here will not add sustain unless the Knee Lever is pushed (See page 150 for more information.).



NOTE:

Remember that the SUSTAIN buttons are on/off switches. If you use them to simply check the sustain length values, you may unintentionally change the on/off status of the effect. Remember to check whether the sustain button lamps are on or off before you start to play.

2) Sustain

The Sustain effect, selectable for the Upper, Lower and Pedal voices, causes voices to gradually fade out when the keys are released. The sustain on/off and sustain length settings are independent for each keyboard, providing maximum expressive control.

To add sustain to the voices and call up the Sustain Length page:

Press one of the SUSTAIN buttons in the SUSTAIN section.

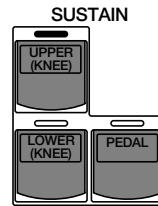

The lamp of the button lights up to indicate that sustain is on. Press the button again to turn sustain off.

SUSTAIN LENGTH Page

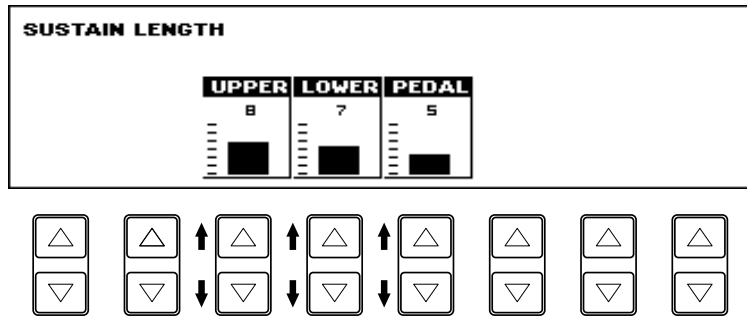

NOTE:

The values here must be set high enough for the sustain effect to be noticeable.

UPPER/LOWER/PEDAL

Determines the length of sustain applied to each keyboard. The display shows the current sustain length values for each keyboard. Range: 0-12

3) Tremolo/Chorus

Tremolo recreates the rich, swirling sound of the popular rotating speaker effect. Just as with a conventional rotating speaker, you can switch between slow and fast speeds. And like a motor-driven speaker, the characteristic tremolo effect gradually changes speed after it is switched. You can also adjust the maximum speed of the effect to suit your playing style. The Tremolo effect can be switched in real time as you play with either the front panel button or the Left Footswitch (when properly set for Footswitch operation).

■ Tremolo Operation

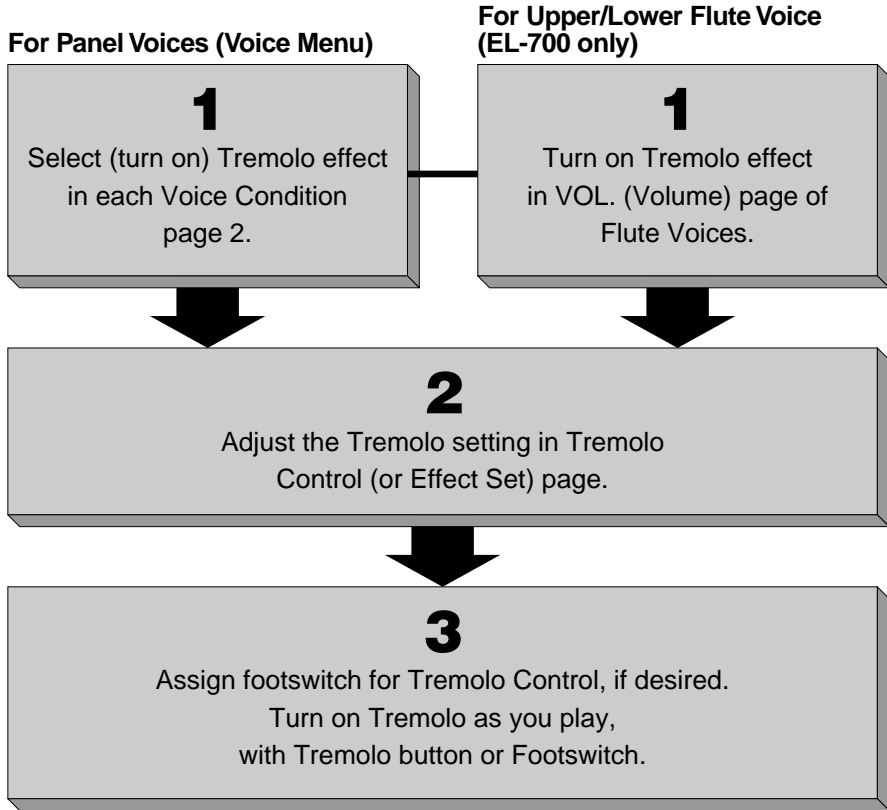

1) Turning on the Tremolo effect (set to standby):

Before you switch Tremolo on and off in real time, you must first turn the effect on in the various voice sections. This doesn't actually start the effect, but merely puts Tremolo in a "standby" condition.

Tremolo can be applied selectively to the voice sections; in other words, the Upper Keyboard voices can have the Tremolo effect while the Lead voices have another effect or no effect at all.

Select (turn on) Tremolo

■ For Lead, Upper, Lower and Pedal (Voice Menu) voices

1. Press the desired voice button on the panel twice to display one of the Voice Condition pages.

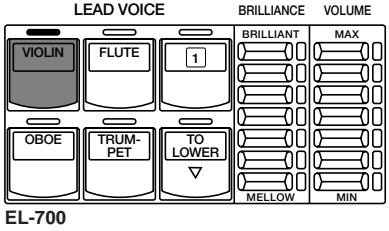

2. Then press the Page buttons to select the Voice Condition page 2.

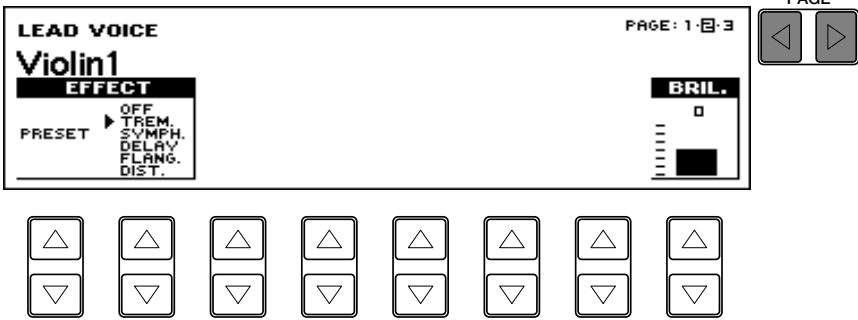

3. Select TREM. to turn on Tremolo for the selected Voice section (or the currently assigned voice group).

■ For Flute Voices (EL-700 only)

1. Press the U. FLUTE VOICE button and/or L. FLUTE VOICE button in the DISPLAY SELECT section to display one of the Flute Voice pages.

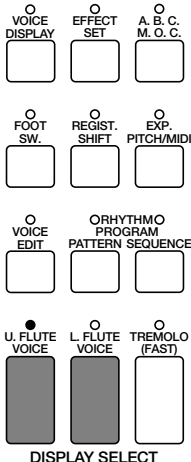

EL-700

2. Then press the Page buttons to select the VOL page.

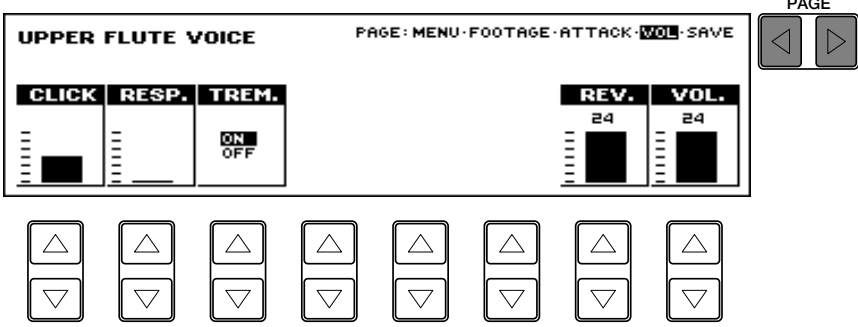

3. Select ON in TREM. turns on Tremolo for the current Flute Voice.

2) Setting the Tremolo effect

Tremolo setting made here are global; in other words, they are applied the same to all voices for which Tremolo has been turned on (set to standby).

To turn on the Tremolo effect and call up the Tremolo Control page:

Press the TREMOLO (FAST) button in the DISPLAY SELECT section.

The lamp of the button lights up to indicate that Tremolo is on.

Press the button again to turn Tremolo off and Chorus on (the LED turns off).

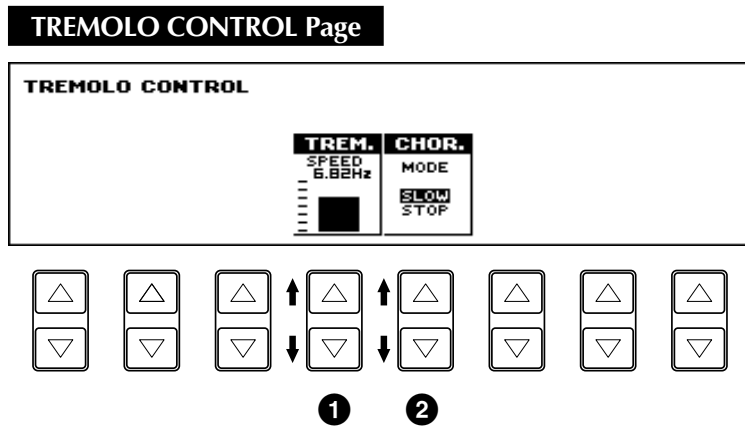

1) TREM. SPEED (Tremolo Speed)

Determines the speed of the Tremolo (rapid rotation) effect.

Range: 4.75Hz - 7.77Hz

2) CHOR. MODE (Chorus Mode)

Determines the effect applied when Tremolo is switched off: a slow chorus effect (SLOW) or STOP. Use the SLOW setting when you want to have a constant rotating speaker sound.

3) Realtime control of Tremolo effect

Once the Tremolo effect has been turned on and set, you can control the effect in real time from the panel or from the Left Footswitch (page 148).

Panel Control

Simply press the TREMOLO (FAST) button in the DISPLAY SELECT section to turn the Tremolo effects on and off while you're playing.

This button functions just like the fast/slow switch on an actual rotating speaker cabinet. When Tremolo is on, the rotation effect is fast; when off (Chorus), it is slow. The speed change is gradual, effectively simulating the slowing down and speeding up of a rotating speaker.

Footswitch Control

You can also use the Left Footswitch to control the Tremolo effect in the same way, if the Footswitch has been properly assigned. (See the section Footswitch Assign on page 148 for details.)

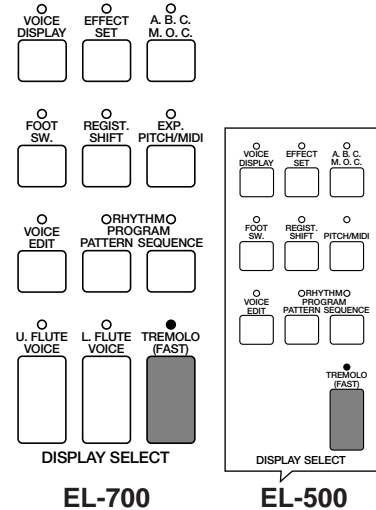

Rhythm and Accompaniment

The Rhythm features of the Electone use actual drum and percussion sampled sounds to automatically play various rhythms. Automatic Accompaniment functions are used with the rhythms, providing appropriate and completely automatic accompaniment to match the style of the selected rhythm. Moreover, the Electone has a Keyboard Percussion feature that allows you to play drum and percussion sounds from the Lower keyboard and Pedalboard.

1 Selecting Rhythms from the Panel

Ten different rhythm categories in various styles can be instantly selected from the front panel. The Electone has many more “hidden” rhythms, however. A total of 66 rhythms are available, and can be selected by using the display.

1) To select and play a rhythm:

- 1 Choose a rhythm by pressing one of the Rhythm buttons in the Rhythm section on the panel.

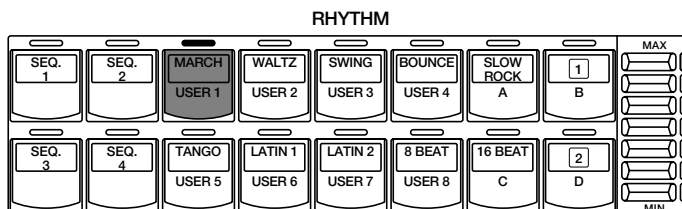

From this display, you can also select other rhythms. These additional patterns are generally variations on the basic rhythm categories.

RHYTHM						ACCOMPANI.	
March1					M	TYPE 1	TYPE 2
March 1	March 2	March 3	Polka 1	Polka 2		TYPE 3	TYPE 4
Coun-try 1	Coun-try 2	Broad-way	Baro-que				

- 2 Press the Data Control button corresponding to the rhythm you wish to play, as you do with the voices. The selected rhythm will be shown at the upper row of LCD.



NOTE:

The chord/bass patterns matching with the designated rhythm will be selected automatically when the A.B.C. function is turned on.

RHYTHM						ACCOMPANI.	
March3					M	TYPE 1	TYPE 2
March 1	March 2	March 3	Polka 1	Polka 2		TYPE 3	TYPE 4
Coun-try 1	Coun-try 2	Broad-way	Baro-que				

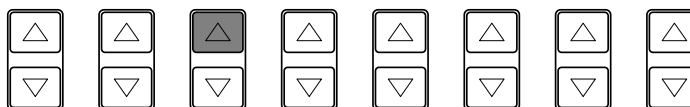

3 Turn the rhythm on. You can use one of three buttons to turn on the rhythm:

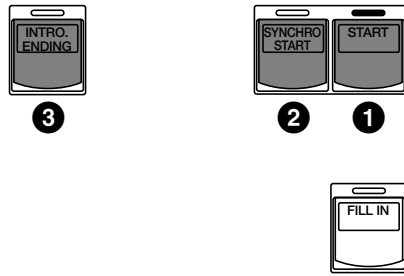

1 START

This button does as its name indicates; the rhythm begins as soon as the button is pressed. To stop the rhythm, press this button again.

2 SYNCHRO START

This button puts the rhythm in “stand-by”; the rhythm will start when you press a note on the Lower keyboard or Pedalboard. To stop the rhythm, press this button again.

3 INTRO. ENDING

Pressing this button automatically adds a short introduction (of up to eight measures) before starting the actual rhythm. First, press the INTRO. ENDING button, then the START or SYNCHRO START button to actually start the rhythm.

While the introduction is playing, the display shows the countdown to the first measure of the pattern. For example, if there is a eight-measure lead-in for a pattern in 4/4 time, the following display appears:

Pressing the INTRO. ENDING button again while the pattern is being played will automatically add an ending phrase before stopping the rhythm.

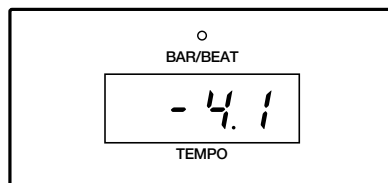

LEAD IN

Pressing the START button while holding down the INTRO. ENDING button automatically plays a special one-measure Lead In, with a click on each beat, to cue you in to the beginning of the song.

4 Set the volume. Press the VOLUME controls to the right of the Rhythm buttons to set the desired level of the rhythm. The controls have seven volume settings, from a minimum of 0, or no sound, to a maximum of full volume.

Fine adjustments in the volume of the rhythm can also be made from the Rhythm Condition page (page 59).

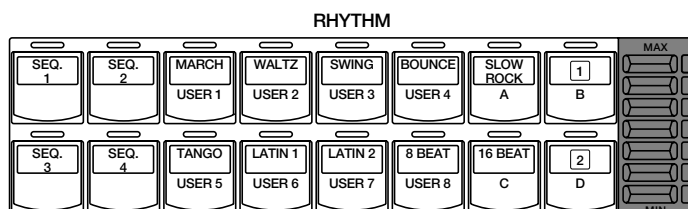

NOTE:
The Left Footswitch can also be used to turn the rhythm on and off in the middle of song. To assign the Footswitch for rhythm control, see page 148.)



NOTE:
ABOUT SYNCHRO START:
Synchro Start functions quite differently when the Auto Bass Chord feature is turned on and the Accompaniment Memory is turned off. The rhythm starts when a key on the Lower keyboard is played, but then immediately stops when the key is released. To keep this from happening, turn the Memory function on. (Refer to the Auto Bass Chord section, page 65, for details on Auto Bass Chord and Memory.)



NOTE:
When the Electone is turned on, the Rhythm Volume is automatically set to 0.

5 Set the tempo.

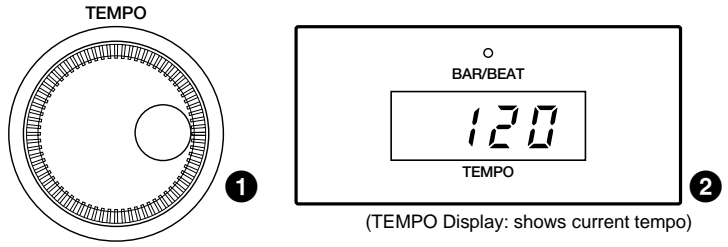

(TEMPO Display: shows current tempo)

1 TEMPO Dial

For adjusting the speed of the rhythm. Turn the dial clockwise to increase the tempo, and counter-clock wise to decrease it.

2 TEMPO Display (BAR/BEAT Indicator)

Shows the current tempo. (Displayed values are given in beats per minute, just as on a conventional metronome.) The tempo range is 40 to 240 beats per minute.

When the rhythm begins playing, the TEMPO display changes function to a Bar/Beat indicator.

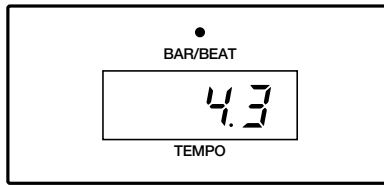

(BAR/BEAT Indicator: shows the current position in the measures)

The number on the left indicates the current bar or measure and the one on the right indicates the number of the beat in each bar. The beat indicator lamp above the display also indicates the beats.



NOTE:

When you turn the TEMPO Dial even while the rhythm is playing, the display momentarily changes to show the current tempo.

2) To use the Fill In patterns:

Fill In patterns are designed to be used as temporary and regular rhythmic breaks to spice up a repeating rhythm. Like the regular rhythms, all Fill In patterns have been designed to perfectly match the bass and chord parts of the Automatic Accompaniment feature.



NOTE:

USING A FILL IN FOR THE START OF A SONG:

Fill In patterns can also be used as introductions; simply press the FILL IN button before starting the rhythm with the START or SYNCHRO START buttons.



NOTE:

PLAYING PARTIAL FILL IN PATTERNS:

You can also start Fill In patterns within a bar, in order to play only the final one or two beats of the Fill In pattern and create additional rhythmic interest. Since the Fill In feature is very sensitive to bar/beat boundaries, you should be very careful to “play” the FILL IN button precisely on (or just slightly before) the beat that you want the Fill In pattern to begin.

1 Select and play a rhythm.

2 As you play the Electone along with the rhythm, occasionally press the FILL IN button.

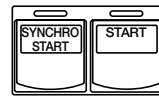

2 Rhythm Condition Pages

The Rhythm Condition includes the following two pages: the Rhythm Condition page used to adjust the rhythms and the Instrument page used to make up each drum/percussion instrument, each of which comprises the rhythms and is playable using the Keyboard Percussion function.

1) To select the Rhythm Condition page:

Choose a rhythm, and press that pattern's panel button again (or again press the Data Control button corresponding to the selected rhythm). (The button should be pressed only once if the Rhythm display has already been called up; otherwise press the button twice.)

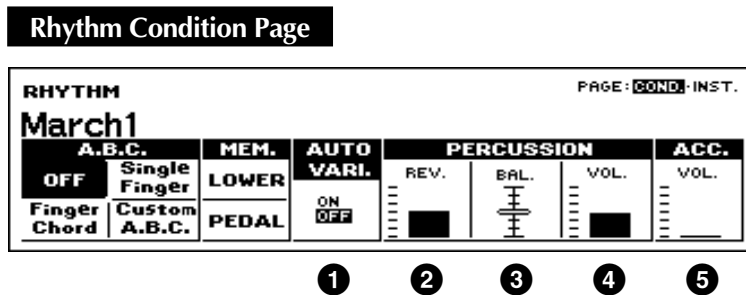

NOTE:

See page 65 for the information on A.B.C.



NOTE:

The Auto Variation function is not applied to some of the rhythms.

1 AUTO VARI. (Auto Variation)

The Auto Variation function lets you set pattern variations to be played automatically. When set to ON, Auto Variation automatically substitutes additional pattern variations to make the rhythm more interesting and complex.

2 PERCUSSION REV. (Reverb)

Determines the amount of reverb applied to the rhythms and percussion sounds used in the rhythms. When the panel REVERB control is set to the minimum, the setting here will have no effect. Range: 0-24
(See page 51 for the detailed information on the Reverb effect.)

3 PERCUSSION BAL. (Balance)

Determines the balance between two main sound types of the rhythms: the drum sounds and the cymbal sounds. Higher settings emphasize the cymbal sounds, while lower settings emphasize the drums.

4 PERCUSSION VOL. (Volume)

Fine adjustment of the overall volume of the rhythms and Keyboard Percussion (page 68).

5 ACC. VOL. (Accompaniment Volume)

(This control is the same as that described in the Accompaniment section, page 67.)

**NOTE:**

Though independent Tune, Pan, Reverb and Volume settings can be made each instrument, only one set of settings is available. (Settings cannot be memorized to Registration Memory.)



The changes made here affect the entire instrument settings including the Preset/User rhythm patterns and Keyboard Percussion. Consequently, you may unintentionally have modified the settings you didn't want to change. Executing the Copy Preset (shown below) operation returns you to the factory preset settings.

**NOTE:**

The volume of the voice section(s) on the keyboard on which you want to set an instrument should be turned off.

**NOTE:**

Loading the registration data created on the ELX-1 will set the Pan, Reverb and Volume settings to the values set for the ELX-1 and reset the Tune setting to the factory preset value. Using registration data created on other Electone models will restore all Instrument Page settings to the factory preset status.

**NOTE:**

Refer to page 125 for the instrument assignments of each set.

2) To select the Instrument page:

Choose a rhythm, and press that pattern's panel button again (or again press the Data Control button corresponding to the selected rhythm) to display the Rhythm Condition page. Then press the Page buttons to select INST. (Instrument) page.

Instrument Page

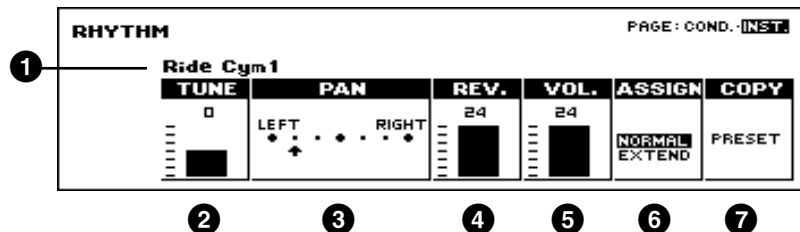

In this page, individual drum and percussion sounds used to make up the Rhythms and Keyboard Percussion can be given independent settings.

1 Instrument Name

This shows the name of the currently selected instrument. To select a different instrument, press the key or pedal to which the sound is assigned. (Refer to page 125 for instrument/key assignments of the Rhythm Pattern Program.)

2 TUNE

Determines the pitch of the currently selected instrument.

Range: -6 - 0 - +6

3 PAN

Determines the position of the currently selected instrument in the stereo image. Seven pan positions are available.

4 REV. (Reverb)

Determines the amount of reverb applied to the currently selected instrument.

Range: 0 - 24

5 VOL. (Volume)

Determines the fine volume setting of the currently selected instrument.

Range: 0-24

6 ASSIGN (NORMAL/EXTEND)

Selects the instrument set you want to use. Two types are available:

NORMAL: Selects the instruments assigned to the Upper/Lower keyboards.

EXTEND: Selects the instruments which are normally assigned to the outside of the keyboard range.

7 COPY./PRESET

Replaces the current user settings with the factory preset settings.

To use the Copy function, press one of the rightmost Data Control buttons. The following display will appear:

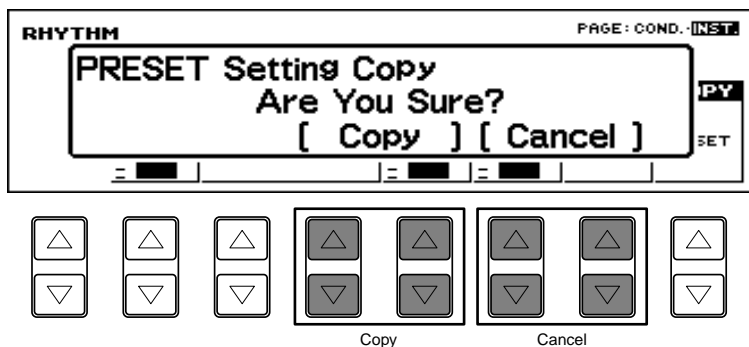

Press any of the Data Control buttons below [Copy] on the display to erase all user settings and restore the preset data. When [Copy] is selected, a “Completed” message momentarily appears on the display. Press any of the Data Control buttons below [Cancel] in the display to abort the operation.

3 Dotted Buttons and User Rhythms

The Rhythm section also has, like the voice sections, dotted buttons from which rhythms can be selected. These dotted buttons function as “wild card” rhythm selectors; any of the rhythms available from the panel buttons, the Rhythm Menu or User rhythms can be selected from these buttons.

1) To select a rhythm from a dotted button:

- 1 Press one of the dotted buttons on the right side of the Rhythm section.

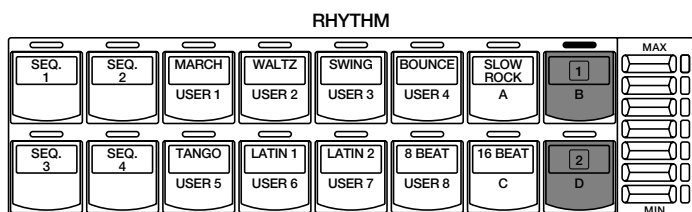

The Rhythm Menu page appears.



 NOTE:

As with the Voice sections dotted buttons, you can set two or three rhythms from the same page to be selected from different buttons (one from the original Rhythm button, and the others from the dotted buttons).

2 Select one of the pages with the Page buttons.

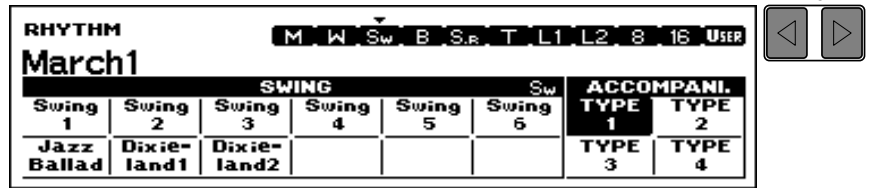

Each page represents the same general rhythm types as those selected from the panel buttons. The currently assigned rhythm name appears at the top of the display when the page has been selected. The rhythm name shown at the top of the LCD is that of the currently assigned rhythm and is irrelevant to the Rhythm Menu below.

3 Press the Data Control button corresponding to the rhythm you wish to use.

2) To call up the User rhythms:

You can select the User page and rhythm when you wish to play the rhythms you've created with the Rhythm Pattern Programmer function (page 139).



NOTE:

When you select the user rhythm with the Lower Rhythmic function turned on, "RHYTHMIC" will be shown above the "ACCOMPANI." on the LCD display.

1 Press Page buttons to select the USER page.

2 Press to select the User rhythm number and its Type.

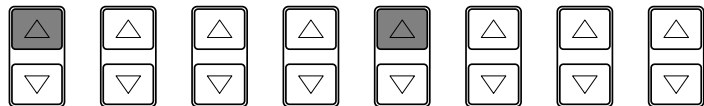
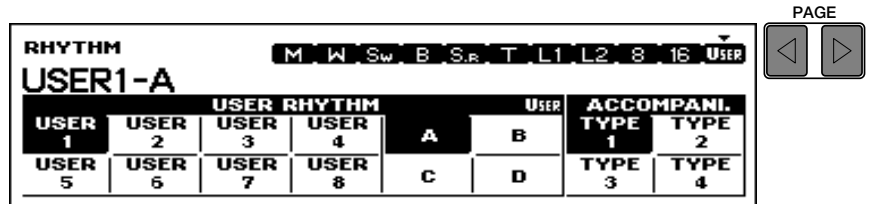

4 Rhythm Menus

This chart lists all 66 of the rhythms available on the Electone.

MARCH

MARCH					
March 1	March 2	March 3	Polka 1	Polka 2	
Country 1	Country 2	Broadway	Baroque		



NOTE:

The Baroque on the March page is configured with accompaniment only; it does not contain any drum or percussion.

WALTZ

WALTZ					
Waltz 1	Waltz 2	Waltz 3	Waltz 4	Waltz 5	
Jazz Waltz 1	Jazz Waltz 2	Jazz Waltz 3	Bolero		

SWING

SWING					
Swing 1	Swing 2	Swing 3	Swing 4	Swing 5	Swing 6
Jazz Ballad	Dixieland 1	Dixieland 2			

BOUNCE

BOUNCE					
Bounce 1	Bounce 2	Bounce 3			
Reggae 1	Reggae 2				

SLOW ROCK

SLOW ROCK					
Slow Rock 1	Slow Rock 2	Slow Rock 3			

TANGO

TANGO					
Tango 1	Tango 2	Tango 3			

LATIN1

LATIN1					
Cha-cha	Rhumba	Beguine			
Mambo	Salsa				

LATIN2

LATIN2					
Samba 1	Samba 2	Samba 3			
Bossa-nova1	Bossa-nova2	Bossa-nova3			

8 BEAT

8 BEAT					
8 Beat 1	8 Beat 2	8 Beat 3	8 Beat 4	8 Beat 5	
Dance Pop 1	Dance Pop 2	Dance Pop 3	Dance Pop 4		

16 BEAT

16 BEAT					
16 Beat 1	16 Beat 2	16 Beat 3	16 Beat 4	16 Beat 5	
16 Beat Funk 1	16 Beat Funk 2	16 Beat Funk 3			

USER RHYTHM

USER RHYTHM					
USER 1	USER 2	USER 3	USER 4	A	B
USER 5	USER 6	USER 7	USER 8	C	D

5 Automatic Accompaniment - Auto Bass Chord (A.B.C.)

The Auto Bass Chord (A.B.C.) function works with the Rhythm section of the Electone to automatically produce chord and bass accompaniment as you play. It adds an entirely new dimension to your performance by effectively putting a full backing band at your disposal. Depending on the feature or mode selected, you can play anything from a single note to a full chord on the Lower key board and hear complete, rhythmical bass and chord accompaniment.

1) To select the A.B.C. function (from the Rhythm Condition page):

Choose a rhythm on the panel, then press that rhythm's panel button again (or again press the Data Control button corresponding to the selected rhythm).

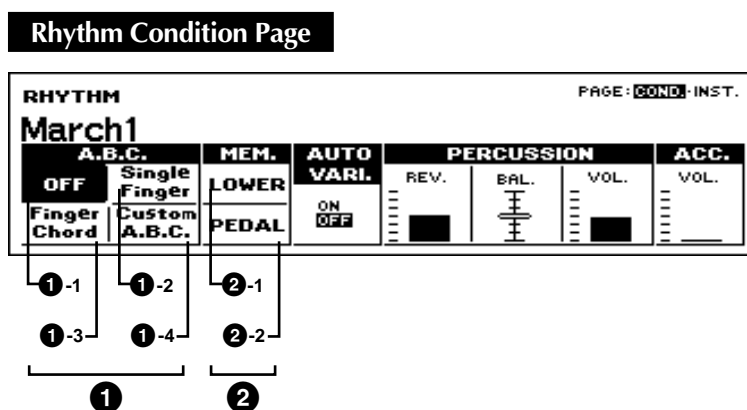

1 A.B.C.

1-1 OFF

Cancels the Auto Bass Chord function.

1-2 Single Finger Mode

The Single Finger mode provides the fastest and easiest means to obtain many different chord/bass combinations, by simply using one, or at most, two or three fingers to play the chords.

1-3 Fingered Chord Mode

The Fingered Chord mode automatically produces bass and chord accompaniment for chords played in the Lower keyboard. It allows you to use a wider range of chord types than in the Single Finger mode. In the Fingered Chord mode, you play all the notes of the chord while the Auto Bass Chord function automatically selects the appropriate bass pattern.

1-4 Custom A.B.C. Mode

The Custom A.B.C. mode is a slight variation on the Fingered Chord mode. It allows you to determine what bass notes will be played in the accompaniment by playing a note on the Pedalboard along with the chords you play in the Lower keyboard.

2 MEM. (Memory)

2-1 LOWER

Selecting this keeps the chord accompaniment of the Lower Keyboard voices playing even after you release your fingers from the Lower keyboard.

2-2 PEDAL

Selecting this keeps the bass accompaniment of the Pedalboard voices playing even after you release your fingers from the Lower keyboard.

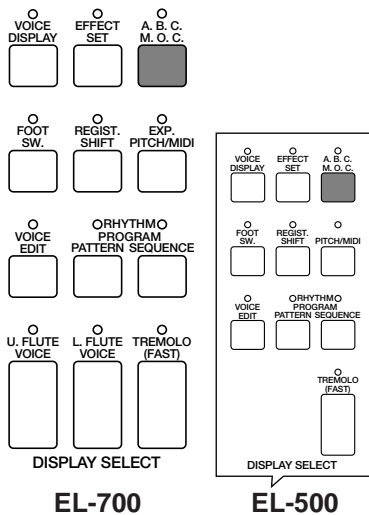

2) To select the A.B.C. function (from the A.B.C./M.O.C. page):

The Auto Bass Chord page can be called up by pressing the A.B.C./M.O.C. button in the DISPLAY SELECT section.

The A.B.C. section on this page are the same as the one found in the Rhythm Condition page.

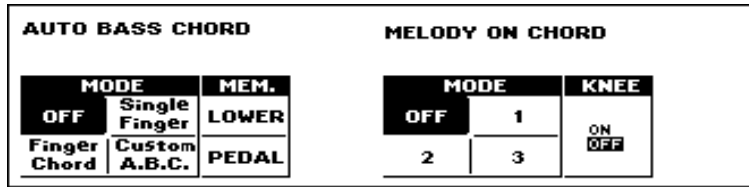

3) Chords Recognized in the Single Finger Mode

Major, minor, 7th and minor 7th chords can all be played in the Single Finger mode.

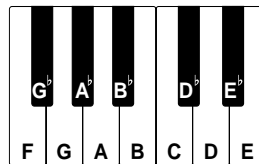

NOTE: With Single Finger, the chord produced will sound in the same octave regardless of where it is played on the Lower keyboard.



PLAYING SINGLE FINGER CHORDS WITHOUT RHYTHM: Auto Bass Chord is generally used with rhythms to create full rhythmic accompaniment, but it can also be used in the Single Finger mode to add full continuous chords to your performance without the use of the rhythm. Simply leave the rhythm off in Single Finger mode, and play Single Finger chords from the Lower keyboard.



If you forget to cancel the Single Finger or Fingered Chord accompaniment functions, single notes that you play will be sounded as continuous chords.



Minor, 7th and minor 7th chords with black key roots (such as Bb or Gb) are played in the same way as those with white key roots.

(Key of C)

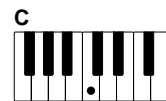

Major chords: Press the root of the chord (the note that corresponds to the chord's name).

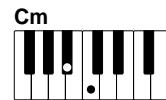

Minor chords: Simultaneously press the root and any one black key to the left of it.



7th chords: Simultaneously press the root and any one white key to the left of it.



Minor 7th chords: Simultaneously press the root as well as any black key and any white key to the left of it.

4) Chords Recognized in the Fingered Chord Mode

(Key of C)

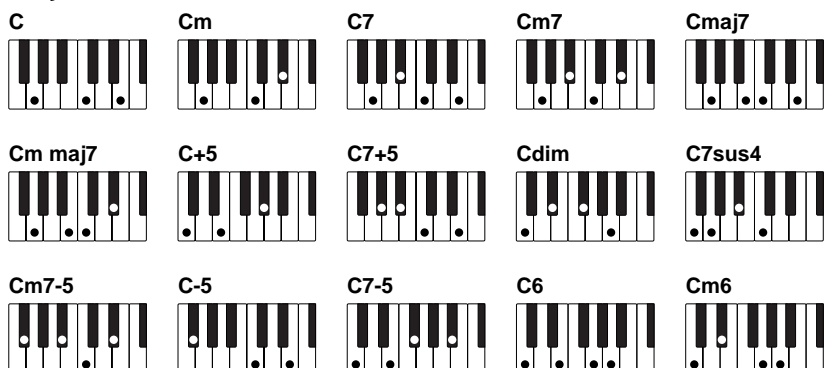

6 Accompaniment Controls

The Accompaniment function described in this section is independent of the A.B.C. accompaniment. When rhythms are used, A.B.C. provides rhythmical chords and bass, while the Accompaniment of this section provides arpeggiated chords and other instrumental embellishments. Accompaniment controls include the setting of the Accompaniment type and its volume. These controls are selected from the Rhythm Menu and Rhythm Condition pages.

To select and set up the Accompaniment controls:

- 1 Press any of the RHYTHM buttons once.

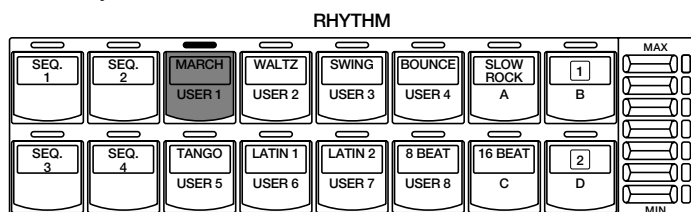

Rhythm Menu Page

RHYTHM						M		ACCOMPANI.	
March1								TYPE 1	TYPE 2
March 1	March 2	March 3	Polka 1	Polka 2				TYPE 3	TYPE 4
Coun-try 1	Coun-try 2	Broad-way	Baro-que						

1

ACCOMPANI. (Accompaniment)

- 1 Type 1-Type 4

These settings provide various types of rhythmic and melodic accompaniment, and generally become more complex according to the type number.

- 2 Press the same rhythm button again to display the Rhythm Condition page.

Rhythm Condition Page

RHYTHM				PAGE: COND. INST.			
March1							
A.B.C. OFF	Single Finger	MEM. LOWER	AUTO VARI. ON OFF	PERCUSSION REV.	BAL.	VOL.	ACC. VOL.
Finger Chord	Custom A.B.C.	PEDAL					

2

- 2 Volume

Determines the volume of the Accompaniment. Accompaniment can also be turned off by setting this parameter to the minimum value. Range: 0 - 24



NOTE:

To turn the Accompaniment function off, press the Data Control button corresponding to the currently selected type. (When off, all types should appear in normal display.)



NOTE:

Even if the Accompaniment Type is changed, the Intro/Ending and Fill In patterns remain the same.



NOTE:

When the Electone is turned on, the Accompaniment Volume is automatically set to 0. Be sure to set the Accompaniment Volume to the appropriate value when using the Accompaniment function.

7 Keyboard Percussion

The Keyboard Percussion function features a total of 120 different drum and percussion sounds, playable from the keyboards and Pedalboard. Keyboard Percussion has two different modes, Preset and User. Preset Keyboard Percussion lets you play 43 different sounds from the Lower keyboard and Pedalboard, while the User Keyboard Percussion lets you freely assign the 120 available sounds to any key or pedal you wish. The two Keyboard Percussion buttons on the panel function as on/off switches for both Keyboard Percussion modes.

1) To use the Preset Keyboard Percussion:

- 1 Turn off the Lower and/or Pedal voices by setting each voice's volume to MIN.
- 2 Turn on the Keyboard Percussion function by pressing the LOWER/1 and/or PEDAL/2 buttons in the KEYBOARD PERCUSSION section on the left side of the panel.



NOTE:

Pressing the KEYBOARD PERCUSSION buttons calls up the Menu display. You can select Preset (LK Preset or PK Preset) or User (one of the eight Users you created). If one of the Users is currently active, select "LK PRESET" (Lower Keyboard Preset) or "PK PRESET" (Pedalboard Preset).



NOTE:

When the Rhythm Pattern Program function (page 123) is engaged, different drum and percussion sounds are available on the upper keyboard.

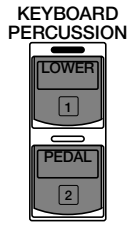

K.B.P.[1]

MENU				
LK PRESET	USER 1	USER 2	USER 3	USER 4
PK PRESET	USER 5	USER 6	USER 7	USER 8

- 3 Set the volume. The volume of the percussion sounds is set together with that of the rhythm volume.

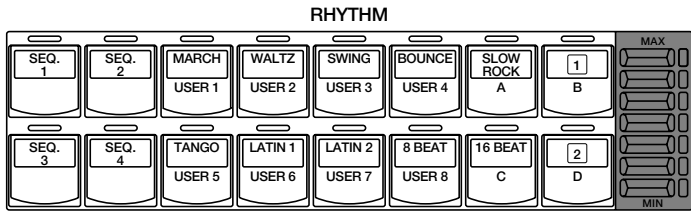

- 4 Play some notes on the Lower keyboard and/or Pedalboard. The 43 percussion sounds have been assigned to the keyboards as shown in the chart below.

Preset Keyboard Percussion

Preset Percussion Assignments for the Lower Keyboard (43)

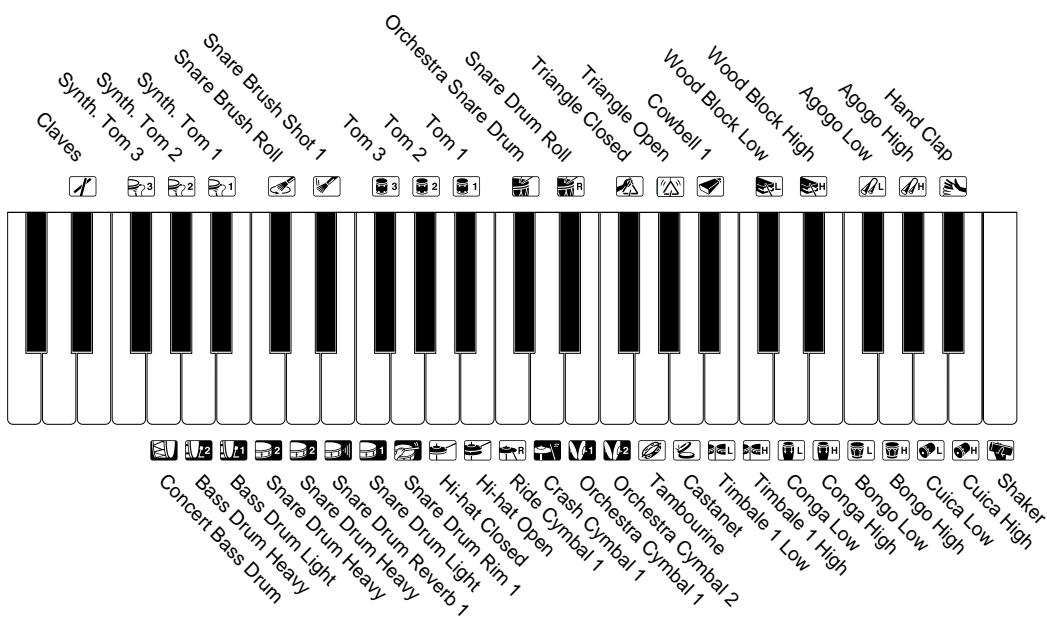

Preset Percussion Assignments for the Pedalboard (18)

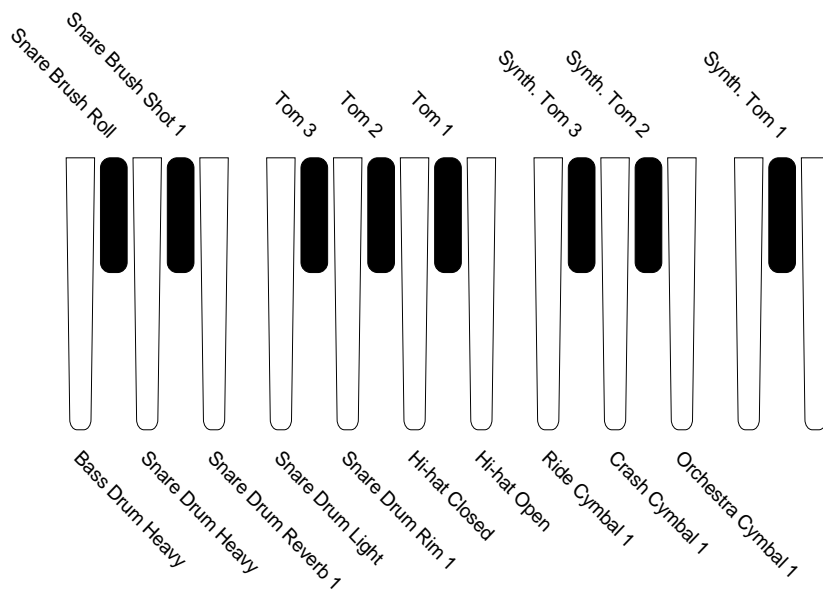

NOTE:

You can rearrange the key assignments of the drum and percussion sounds using the following User Keyboard Percussion function.

2) To use the User Keyboard Percussion

A total of 120 different drum and percussion sounds can be assigned to any key or pedal, and your original setups can be saved to eight memory locations: User 1 through User 8. (For this example, use User 1.)

- 1 Turn on the Keyboard Percussion function by pressing the LOWER/1 button in the KEYBOARD PERCUSSION section.

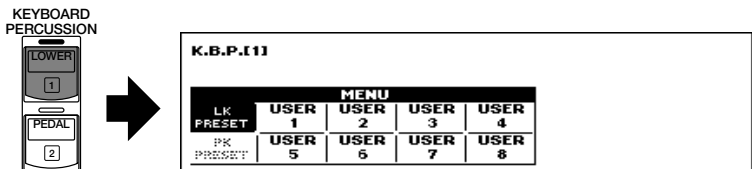

The Menu display appears on the LCD, and indicates that the LK Preset is currently selected. The Menu can be selected from LK (Lower Keyboard) PRESET and eight Users, USER 1 through USER 8.

When the PEDAL/2 button is used to call up the Menu display:

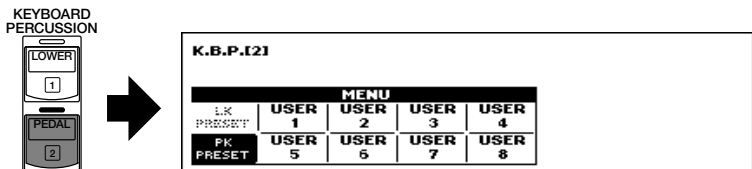

The Menu can be selected from PK (Pedalboard) PRESET and eight Users, USER 1 through USER 8.

- 2 Press one of the Data Control buttons corresponding to USER 1 to select USER1. The MENU/ASSIGN page indication appears at the top right corner of the display.



NOTE:

USER 1 and USER 2 contain the LK PRESET data and PK PRESET data, respectively, as those defaults.



NOTE:

See page 74 for the information on "Copy" function, which will be added to the right side of the display when a User Keyboard Percussion is selected.

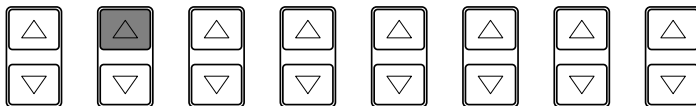
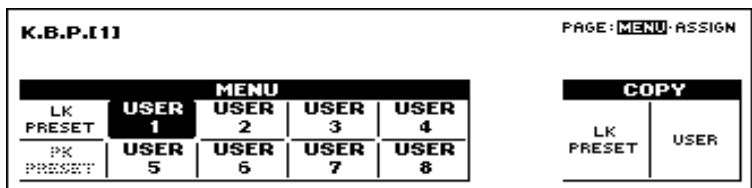

- 3 Select the ASSIGN page by pressing the Page buttons. The display will be replaced with the Assign Page:

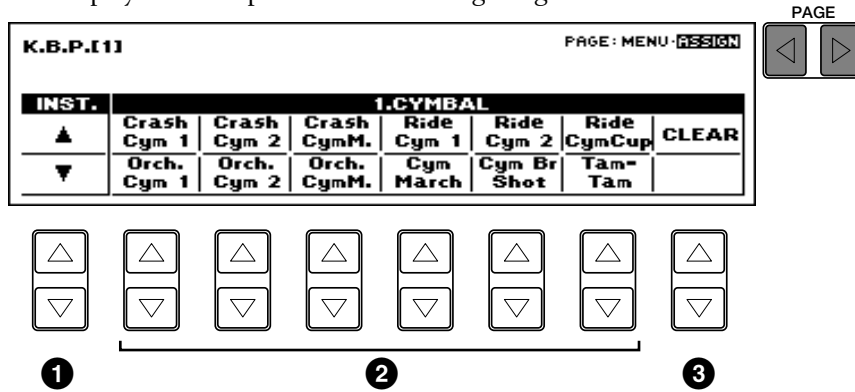

- 1 **INST. (Instrument)**
Use the Data Control buttons below INST. on the display to page through the 12 available Instrument categories. (Refer to the User Keyboard Percussion Categories list below.)
- 2 **Instrument Names**
The individual instruments are shown in the display and can be selected with the appropriate Data Control buttons.
- 3 **CLEAR**
This function is used to erase User assignments for User 1. CLEAR works in two ways: either to erase a single instrument, or to erase all instruments. (See step #5 below.)

User Keyboard Percussion Categories

Page 1

1.CYMBAL					
Crash Cym 1	Crash Cym 2	Crash CymM.	Ride Cym 1	Ride Cym 2	Ride CymCup
Orch. Cym 1	Orch. Cym 2	Orch. CymM.	Cym March	Cym Br Shot	Tam-Tam

Page 2

2.HI-HAT					
HH Open	HH Close	HH Pedal1	HH Pedal2		
Analog HH O	Analog HH C				

Page 3

3.SNARE DRUM					
SD Light	SD Heavy	SD Rim 1	SD Rim 2	SD Ac-cent1	SD Ac-cent2
SD Re-verb1	SD Re-verb2	Synth. SD	Orch. SD	SD Roll	Analog SD

Page 4

4.SNARE BRUSH					
SD Br Shot 1	SD Br Shot 2	SD Br Roll			

Page 5

5.TOM						
Tom 1	Tom 2	Tom 3	Tom 4			
Tom Br Shot 1	Tom Br Shot 2	Tom Br Shot 3	Tom Br Shot 4	Synth. Tom 1	Synth. Tom 2	Synth. Tom 3

Page 6

6.BASS DRUM					
BD Light	BD Heavy	BD Attack	Synth. BD	BD March	ConcertBD
Analog BD 1	Analog BD 2				

Page 7

7.CONGA/BONGO					
Conga High	Conga Low	Conga Slap	Conga Muff.	Conga Slide	
Bongo High	Bongo Low	Bongo Slap	Bongo Mute		

Page 8

8.CUICA/SURDO					
Cuica High	Cuica Med.	Cuica Low	Tambo-rimO.	Tambo-rimM.	
Surdo Open	Surdo Mute	Surdo Rim	Surdo Muff.		

Page 9

9.TIMBALES/COWBELL					
Timbale1 H.	Timbale1 L.	Timbale2 H.	Timbale2 L.	Timbale3 H.	Timbale3 L.
Timbale4 H.	Timbale4 L.	Cowbell 1	Cowbell 2	Cowbell 3	Cowbell 4

Page 10

10.PERCUSSION1					
Cabasa	Shaker	Mara-cashH.	Mara-cashL.	Guiro Short	Guiro Long
Wood High	Wood Med.	Wood Low	Claves	Castanet	Vibra-slap

Page 11

11.PERCUSSION2						
Agogo High	Agogo Low	Trian-gleO.	Trian-gleC.	Wind-bell 1	Wind-bell 2	
Tambou-rine	Pan-deiro	Bell	Hand Claps	Finger-snap	Scra-tch	Noise Per.

Page 12

12.PERCUSSION3						
Kotsu-zumi1	Kotsu-zumi2	Kotsu-zumi3	Kotsu-zumi4	Ohtsu-zumi1	Ohtsu-zumi2	
Taiko 1	Taiko 2	Ohdai-ko 1	Ohdai-ko 2	Take-goe 1	Take-goe 2	Take-goe 3

4 To assign an instrument to a particular key or pedal: simultaneously hold down the Data Control button corresponding to the desired instrument and press the key (or pedal) to which the instrument is to be assigned.

The newly assigned instrument name and key are shown near the top of the display.

K.B.P.111		PAGE: MENU: ASSIGN					
LK A1 : BD Heavy							
INST.	6.BASS DRUM						
▲	BD Light	BD Heavy	BD Attack	Synth. BD	BD March	Con-certBD	CLEAR
▼	Analog BD1	Analog BD2					

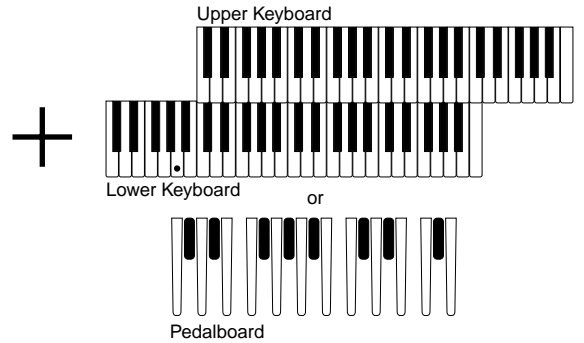
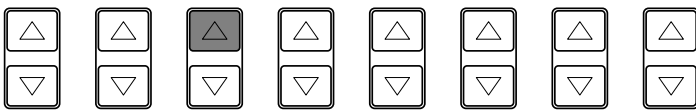

Continue the operation above to build up your own User Keyboard Percussion set.

5 To erase an instrument/key assignment, use the Clear function. Clear can be used in two ways: to erase one instrument or all instruments.

■ **To erase one instrument:**

Simultaneously hold down the Data Control button corresponding to CLEAR and press the key (or pedal) corresponding to the instrument you wish to erase. (A short “beep” sound indicates that the instrument has been erased.)

■ **To erase all instruments:**

1. Press, then release the Data Control button corresponding to CLEAR. The following display appears, prompting confirmation of the operation.

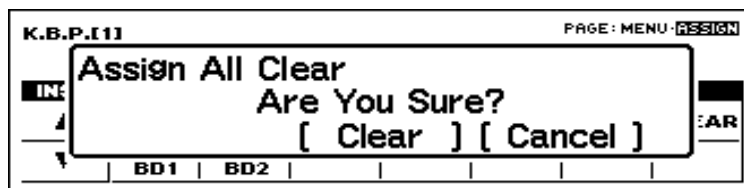

2. Press any of the Data Control buttons below [Clear] in the display to erase all data. When [Clear] is selected, a “Completed” message momentarily appears on the display. Press any of the Data Control buttons below [Cancel] in the display to abort the operation.



NOTE:

Though eight User Keyboard Percussion setups can be created, they cannot be memorized to Registration Memory. Only on/off data and the Keyboard Percussion Menu are memorized to Registration Memory.



NOTE:

Two User Keyboard Percussions currently selected by LOWER/1 and PEDAL/2 are playable if both buttons are on.



NOTE:

When creating a User Rhythm pattern, the instrument assignments are different from the ones described here. (See page 125 for Rhythm Pattern Program instrument assignments.)

3) Other User Keyboard Percussion Functions

Additional operations in the User Mode include copying of Lower/Pedal Preset Keyboard Percussion to one of the Users, and copying from one User location to another. The copy operations here are convenient for creating a basic foundation over which you can make your own custom Keyboard Percussion setups, without having to start from scratch.

■ To copy the Lower Preset Keyboard Percussion to one of the Users:

1. Select the MENU page by using the Page buttons.

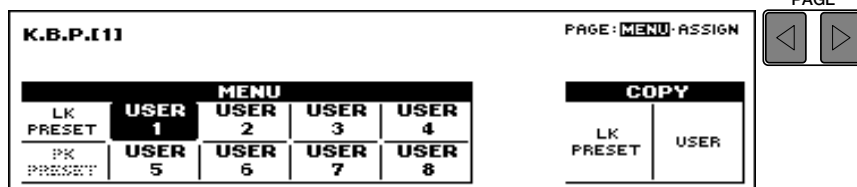

COPY/LK PRESET (COPY/PK PRESET)

Copies Lower Preset Keyboard Percussion (Pedal Preset Keyboard Percussion) to one of the eight Users.

2. With USER 1 selected as the Menu (for this example, use User 1), press one of the Data Control buttons below “LK PRESET” on the COPY window. The following display appears, prompting confirmation of the operation.

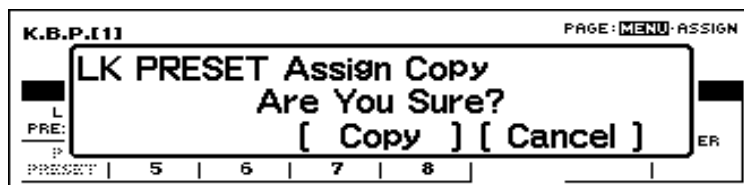

3. Press any of the Data Control buttons below [Copy] in the display to copy the Lower Preset. When [Copy] is selected, a “Completed” message momentarily appears on the display. Press any of the Data Control buttons below [Cancel] in the display to abort the operation. The Pedal Preset Keyboard Percussion (PK PRESET) can be copied in the same way.

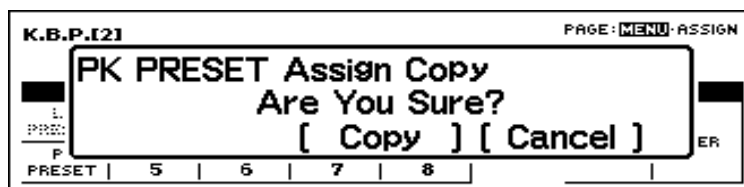

■ **To copy from one User location to another:**

1. Select the MENU page by using the Page buttons.

COPY/USER

Copies one of the eight Users to another.

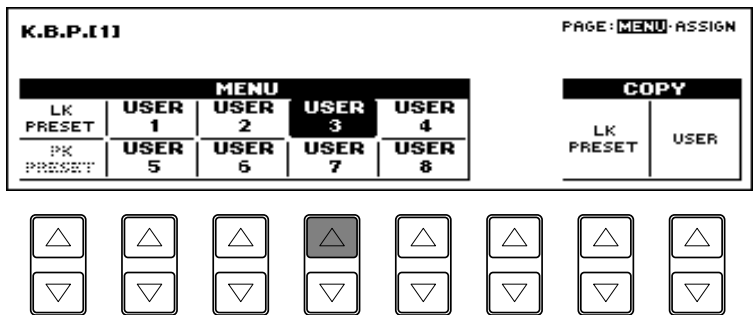

2. With USER 3 selected as the MENU (for this example, use User 3 as the destination and User 1 as the source), press one of the Data Control buttons below “USER” in the COPY window. The following display appears, prompting confirmation of the operation.

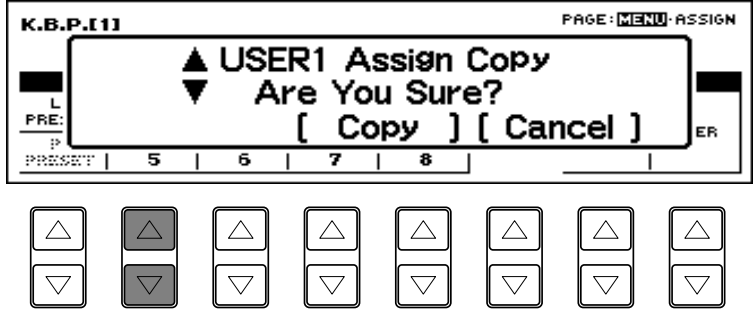

3. Select a User as the copy source (copied from) by pressing the Data Control buttons corresponding to the ▲ marks.
4. Press any of the Data Control buttons below [Copy] in the display to copy from the source (USER 1) to the destination (USER 3). When [Copy] is selected, a “Completed” message momentarily appears on the display. Press any of the Data Control buttons below [Cancel] in the display to abort the operation.

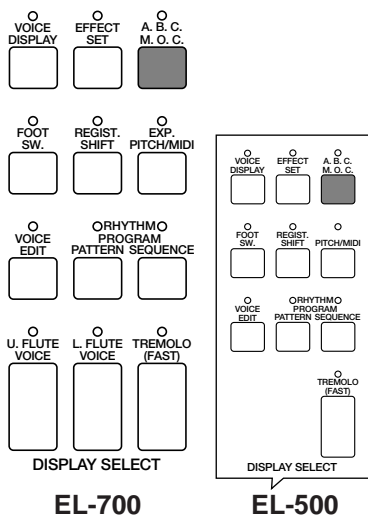

8 Melody On Chord (M.O.C.)

The Melody On Chord (M.O.C.) feature automatically adds a harmony part to the melodies you play on the Upper keyboard. The harmony is derived from the chords you play on the Lower keyboard — or from the chords that are played for you, if you use Automatic Accompaniment. Melody On Chord has three different modes, each providing a different set of harmonies to accompany the melody played. The modes are selected from the A.B.C./M.O.C. page.

To select the M.O.C. function:

Press the A.B.C./M.O.C. button in the DISPLAY SELECT section.

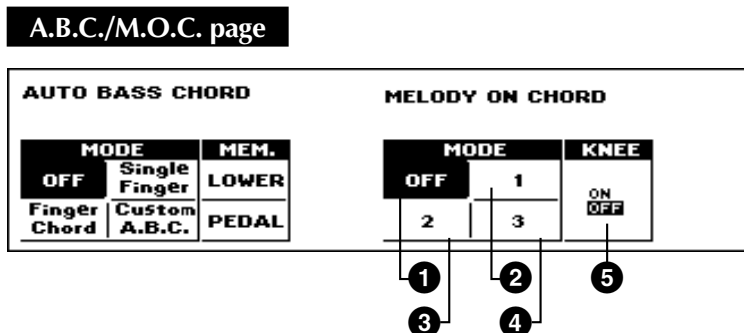

MELODY ON CHORD

- ❶ **OFF**
Cancels the Melody On Chord function.
- ❷ **Mode 1**
Produces harmonies of up to two notes in a range close to the melody played.
- ❸ **Mode 2**
Produces harmonies of up to three notes in a range close to the melody played.
- ❹ **Mode 3**
Produces harmonies of up to four notes in a range relatively distant from the melody played.
- ❺ **KNEE**
On/off switch for Knee Lever control over Melody On Chord operation. To use the Melody On Chord function with Knee Lever control (page 151), first switch the Knee setting to ON, then select one of the three modes (described above). When the control is on, pressing the Knee Lever to the right activates the Melody On Chord function.



NOTE:

Melody On Chord applies only when the Upper keyboard voice section's volume is set to the appropriate value.

Registration Memory allows you to store virtually all the settings you make on the panel and LCD, providing a convenient way to instantly change all voice settings and rhythms while you're playing, with the simple touch of a single button on the Registration Memory panel. The buttons are conveniently located between the Upper and Lower keyboards for easy access while playing.

EL-700



EL-500

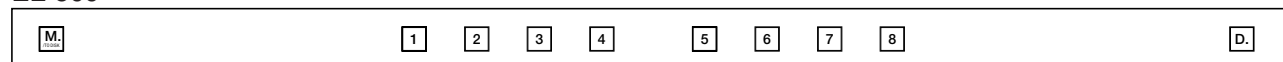

Functions and settings that cannot be memorized are:

- Reverb type
- Attack mode in Flute Voices (EL-700 only)
- Pan, Reverb, Tune and Volume settings for the instruments (Drum and percussion sounds)
- User Keyboard Percussion settings (except for User numbers currently assigned to the Lower/Pedal buttons)
- Registration Shift settings
- Pitch/Transpose settings
- Voice Edit settings (except for User voice numbers currently assigned to the Dotted buttons)
- Voice Disk voices
- User rhythms in the Rhythm Pattern Program (except for User rhythm numbers currently assigned to the Dotted buttons)
- Rhythm Sequences
- MIDI settings
- Lead Initial Touch setting

1 Storing Registrations

Newly created registrations you make can be stored to the Registration Memory panel buttons. All registrations in Registration Memory can also be saved to floppy disk for future recall.

To store registrations to the Registration Memory:

- 1 After creating your original registration, decide which numbered button you wish to store.
- 2 While holding down the M (Memory) button in the Registration Memory section, press the numbered button to which you wish to save your registration.

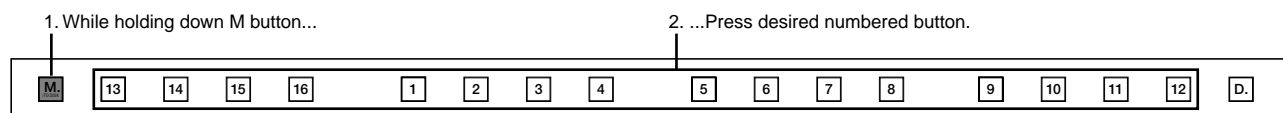

EL-700

When the registration is stored, the numbered button flashes momentarily.



NOTE:

Although the number of the Registration Memory buttons of EL-500 are limited to eight, from Registration Memory 1 through Registration Memory 8, the Registration Memory 9 through Registration Memory 16 can be accessible when using MDR playback and Registration Shift functions.

2 Selecting Registrations

Simply press the numbered button that corresponds to the registration you wish to select.

Using the D (Disable) button:
 Rhythm and automatic accompaniment patterns also change when you select different Registration Memory buttons. Pressing the D (Disable) button allows you to keep the same rhythm and accompaniment patterns throughout all your registration changes, or make your own rhythm selections if you want to.

3 Saving the Registration Data to Disk



NOTE:

See pages 93 and 94 for the details on saving/recalling registrations to/from the M.D.R.

1

Insert a formatted disk into the disk slot under the Music Disk Recorder (M.D.R.).
 Make certain that the disk is either blank or has data you can erase. If the disk is new and unformatted, you will have to format it. Refer to the instructions how to format a disk (page 86).

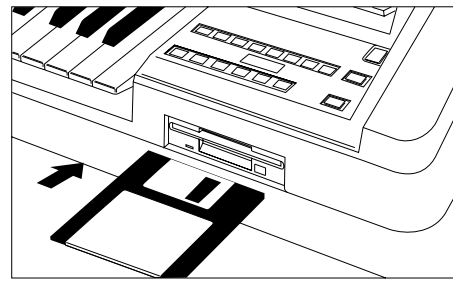

NOTE:

No song names will be provided for the songs recorded by the other Electone models.

2

Select a song number on the M.D.R. using the SONG SELECT buttons. You can also select a song number shown on the display using the appropriate Data Control button and (if necessary) using Page buttons to display the appropriate page. A song name is displayed next to the song number which already contains data.

SONG NAME		PAGE	UTIL.
1:	5:	2:	CHANGE NAME
2:	7:	3:	
3:	9:	4:	
4:	11:	5:	
5:	13:		

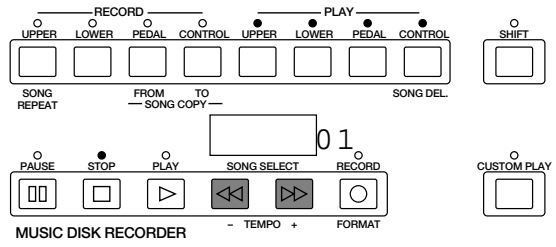

NOTE:

You can freely name the songs you have recorded. See page 89 for the details.

There are 40 songs (ten song numbers on the four pages), or memory locations, available on a single disk.

3 While holding down the RECORD button on the M.D.R., press the M (Memory) button in Registration Memory.

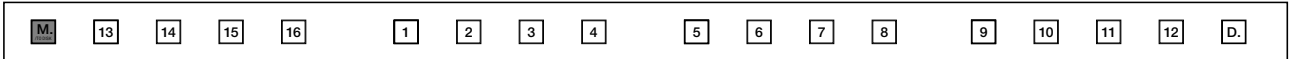
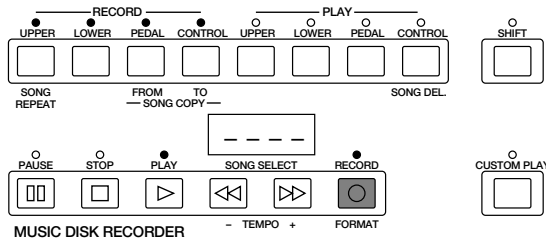

EL-700

This operation saves all 16 registrations (eight registrations with EL-500) in Registration Memory to one song. The other 39 available songs on the disk can be used for saving additional batches of 16 registrations.

4 Registration Shift

The Registration Shift function allows you to change registrations, all the settings you make on the panel and LCD, without taking your hands from the keyboards. By using the Right Footswitch on the Expression Pedal, you can “jump” to a specified registration or step through the panel registrations in sequence, either in numeric order or in any order you specify. Registration Shift has three modes: Shift, Jump and User.

To select the Registration Shift functions:

Press the REGIST. SHIFT button in the DISPLAY SELECT section.

REGIST SHIFT Page

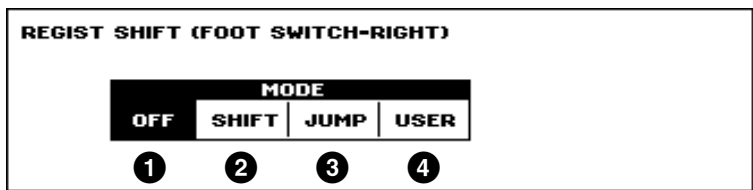

- 1 OFF**
Turns off the Registration Shift assignment.

- 2 SHIFT**
Selects the Shift mode. In the Shift mode, each press of the Right Footswitch selects the Registration Memory presets in their numerical order. After the last preset is reached, the function “wraps around” to select the first preset again. The numbered buttons light up as they are selected.

■ To set the Shift mode function:

Press any of the Data Control buttons below SHIFT in the Registration Shift page.

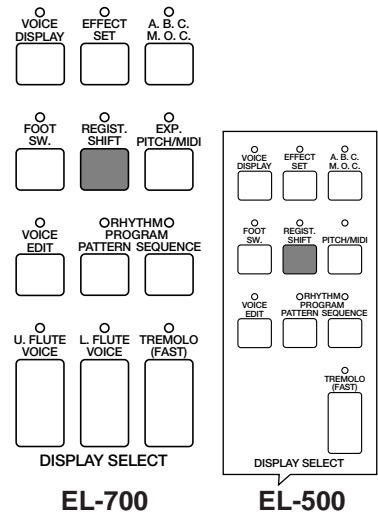

NOTE:

Even with the EL-500 each press of the Right Footswitch selects the Registration Memory numbers from 1 through 16, to accomplish the compatibility with its upper models. A press of the Right Footswitch after reaching the last number (16) returns both models to the number 1.

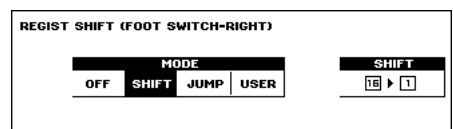



NOTE:

Although the number of the Registration Memory buttons of EL-500 are limited to eight, from Registration Memory 1 through Registration Memory 8, you can select the other eight Registration Memory numbers, the Registration Memory 9 through Registration Memory 16. This means that you can change the Registration Shift data created with the upper models such as EL-700 and EL-900.

3 JUMP

Selects the Jump mode. In the Jump mode, each press of the Right Footswitch selects a specified panel registration.

To set the Jump mode function:

1. Press any of the Data Control buttons below JUMP in the Registration Shift page.
The Jump “destination” appears at the right side of the LCD.

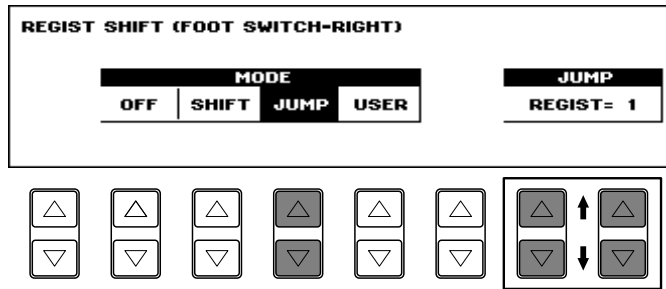

2. Enter the desired registration number using the Data Control buttons to select the registration number.

4 USER

Selects the User mode. In the User mode, each press of the Right Footswitch selects registrations according to the order you specify.

To set the User mode function:

1. Press any of the Data Control buttons below USER in the Registration Shift page.
The page information, indicating that the Edit page is available, appears at the top right section of the LCD.

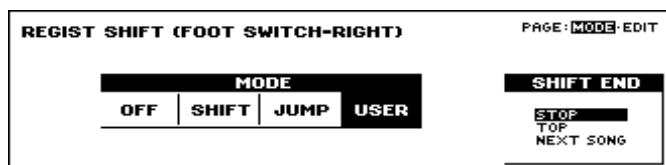

2. Press any of the Data Control buttons below SHIFT END to determine how to terminate the registration shift function.

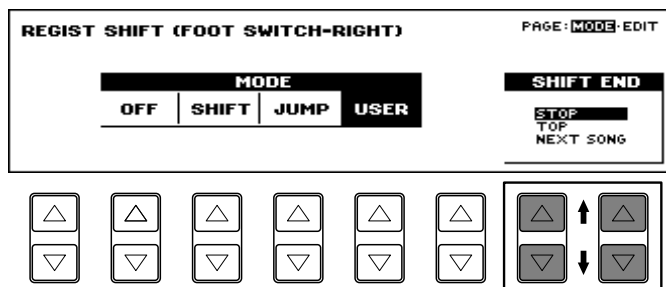

STOP: Selects the last registration and quits the operation.

TOP: After reaching the last preset, then selects the first preset again and repeats the operation.

NEXT SONG: After reaching the last preset, then calls up the registration data of the next song. This function is handy for you to play a song containing more than 16 registrations.

Recording the songs onto the M.D.R. using this function allows you to play back them successively.

3. Press the Page buttons to select the EDIT page.

The Edit page appears.

There are two pages in the User mode: Mode and Edit.

Select the Edit page to program the desired sequence.

EDIT Page

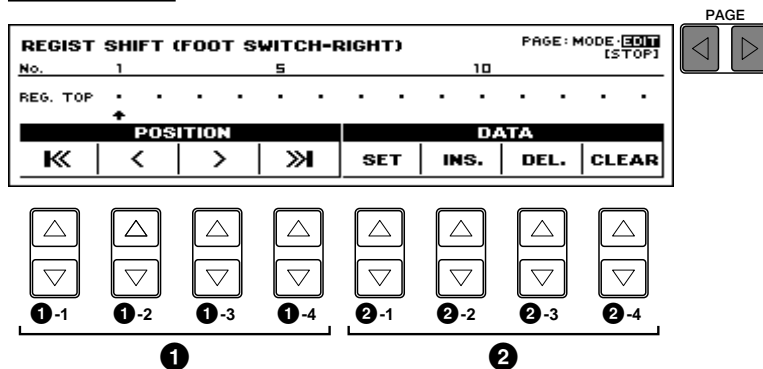

1 POSITION (Cursor Controls)

The cursor controls are used to move the cursor (the arrow in the display) along the registration row in the display. Entered registration numbers are shown in boxes, while the numbers in the row above indicate the number of successive presses of the Right Footswitch.

Move the cursor to the point you wish to edit.

1-1 |<< Moves the cursor to the first position.

1-2 < Moves the cursor one step to the left.

1-3 > Moves the cursor one step to the right.

1-4 >>| Moves the cursor to the last position.

2 DATA (Data Controls)

The data controls are used to enter and delete registration numbers in the registration row. Move the cursor to the desired position and edit the registration data.

2-1 SET

For initially entering a registration number to a blank space in the registration row, or for replacing a number at the current cursor position. To enter a number, press the desired Registration Memory button (the selected button will light), then press the Data Control button corresponding to SET. After using SET to enter registrations, the cursor can be moved among the numbers.



NOTE:

Always press the PLAY button to start the songs and activate this function on the M.D.R. The CUSTOM PLAY button will not cause to activate the Next Song function.



NOTE:

Using the Next Song function will not read the User voices, and the User rhythm patterns/sequences while playing back a rhythm.



NOTE:

The cursor cannot be moved unless registration numbers have been entered.



NOTE:

Though about 15 Registration Shift steps are shown in the display at one time, up to 80 steps can be memorized; use the cursor controls to access the undisplayed steps.

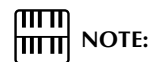

NOTE:

The Shift End (see above) mark cannot be moved using the cursor controls.



NOTE:

The Shift End mark (for Top and for Next Song) will automatically be put at the end of the registrations you entered when TOP or NEXT SONG is selected as the Shift End on the Mode page.



NOTE:

In the case of the EL-500 the registration numbers from 9 through 16 are shown in the dashed line-boxes.

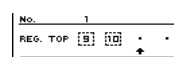

2-2 INS. (Insert)

For inserting a registration number just before the current cursor position. The new registration number is inserted at the cursor position and all other numbers to the right of the cursor are moved to accommodate the new numbers. To perform the operation, first move the cursor to a numbered position. Then press the desired Registration Memory button (the selected button will light), and press the Data Control button corresponding to INS.

2-3 DEL. (Delete)

For deleting a registration number at the current cursor position. To delete the unnecessary number, move the cursor to a numbered position and press the Data Control button corresponding to DEL.

2-4 CLEAR

For erasing all current user Registration Shift Settings.

After selecting CLEAR, the following display appears:

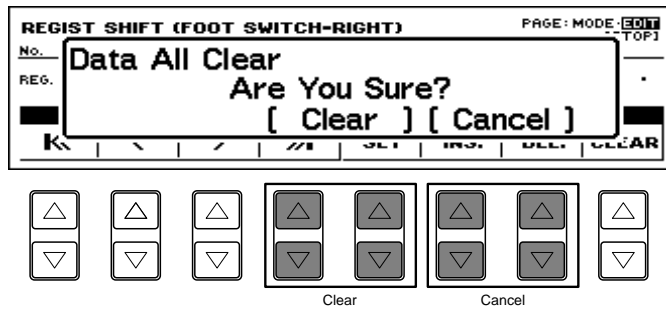

Select [Clear] to clear all data. The message “Completed!!” momentarily appears on the LCD and returns to the previous display.

Select [Cancel] to abort the operation.

Registration numbers cannot be entered beyond the Registration Shift function’s capacity of 80. The following message momentarily appears when the 80 spaces have been filled: First delete unnecessary registrations, then perform the operation again.

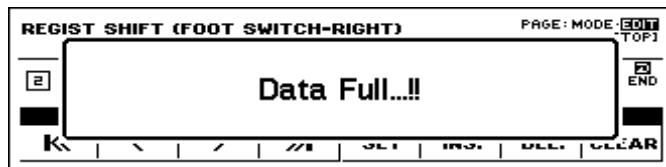

Resetting the Electone to the Factory Preset (Power On Reset)

All current settings including Registration Memories, User voices and User rhythms can be deleted at once by using the Power On Reset function.

To reset the all settings:

- 1 Turn off the power.
- 2 While holding down the top left Data Control button, turn the power back on.

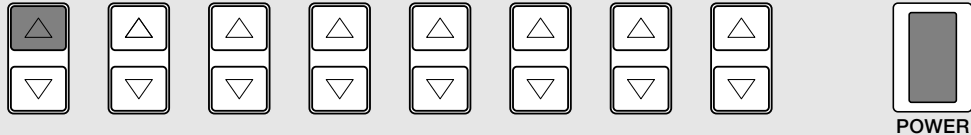

Be careful when using this operation, since it erases all your existing data. Always save your important data to a floppy disk using M.D.R. (page 84) in advance.

Turning the Electone off erases all panel settings you have made. When the Electone is turned on, Basic Registration 1 is automatically selected. If you have made panel settings you wish to keep, save them to Registration Memory before turning the Electone off.

You can, however, restore the panel settings that were made before the Electone was last turned off. In doing this, first be careful NOT to press any panel buttons (excepting those in Basic Registration) after you turn the Electone back on. Then, to restore the previous settings, hold down the M./TO DISK (Memory) button and press D. (Disable) button.

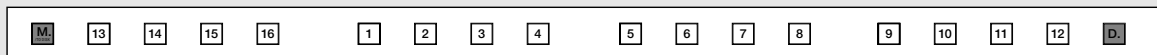

EL-700

The Music Disk Recorder (M.D.R.) is a sophisticated recording device built into the Electone that lets you record your performances and registration settings. The Music Disk Recorder not only records the notes you play; it also remembers the voices and rhythms you select, the front panel controls you change, as well as all expression pedal, footswitch and knee lever positions, to reproduce your performance exactly as you play it. Moreover, the M.D.R. lets you play back commercially available XG song data, and allows you to execute song copy operation even between different disks and disk copy operation which makes it possible to create a backup disk.

1 Precautions

Be sure to handle floppy disks and treat the disk drive with care. Follow the important precautions below.

Compatible Disk Type

3.5" 2DD and 2HD type floppy disks can be used. A blank 2HD floppy disk has been included with your Electone for you to record your performances.

Inserting/Ejecting Floppy Disks

■ **To insert a floppy disk into the disk drive:**
Hold the disk so that the label of the disk is facing upward and the sliding shutter is facing forward, towards the disk slot. Carefully insert the disk into the slot, slowly pushing it all the way in until it clicks into place and the eject button pops out.

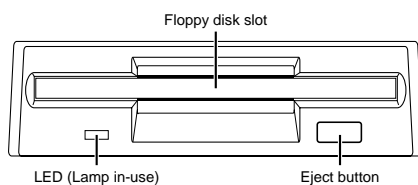
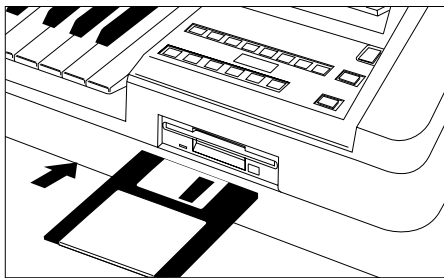

NOTE:

When the EL-700/500 is turned on, the LED below the floppy disk slot will be lit indicating that the M.D.R. is ready to use.

To eject a floppy disk:

- ❗ Before ejecting the disk, be sure to confirm that the M.D.R. is stopped (check if the LED above the STOP button in the M.D.R. section is lit).
Press the eject button slowly as far as it will go; the disk will automatically pop out. When the disk is fully ejected, carefully remove it by hand.
- ⊘ **Never attempt to remove the disk or turn the power off during recording, reading and playing back. Doing so can damage the disk and possibly the disk drive.**
- ❗ If the eject button is pressed too quickly, or if it is not pressed in as far as it will go, the disk may not eject properly. The eject button may become stuck in a half-pressed position with the disk extending from the drive slot by only a few millimeters. If this happens, do not attempt to pull out the partially ejected disk, since using force in this situation can damage the disk drive mechanism or the floppy disk. To remove a partially ejected disk, try pressing the eject button once again, or push the disk back into the slot and then repeat the eject procedure.
- ❗ **Be sure to remove the floppy disk from the disk drive before turning off the power. A floppy disk left in the drive for extended periods can easily pick up dust and dirt that can cause data read and write errors.**

Cleaning the Disk Drive Read/Write Head

- Clean the read/write head regularly. This instrument employs a precision magnetic read/write head which, after an extended period of use, will pick up a layer of magnetic particles from the disks used that will eventually cause read and write errors.
- To maintain the disk drive in optimum working order Yamaha recommends that you use a commercially-available dry-type head cleaning disk to clean the head about once a month. Ask your Yamaha dealer about the availability of proper head-cleaning disks.
- ⊘ Never insert anything but floppy disks into the disk drive. Other objects may cause damage to the disk drive or floppy disks.

About the Floppy Disks

■ To handle floppy disks with care:

- ! Do not place heavy objects on a disk or bend or apply pressure to the disk in any way. Always keep floppy disks in their protective cases when they are not in use.
- ⊘ Do not expose the disk to direct sunlight, extremely high or low temperatures, or excessive humidity, dust or liquids.
- ⊘ Do not open the sliding shutter and touch the exposed surface of the floppy disk inside.
- ⊘ Do not expose the disk to magnetic fields, such as those produced by televisions, speakers, motors, etc., since magnetic fields can partially or completely erase data on the disk, rendering it unreadable.
- ⊘ Never use a floppy disk with a deformed shutter or housing.
- ⊘ Do not attach anything other than the provided labels to a floppy disk. Also make sure that labels are attached in the proper location.

■ To protect your data (Write-protect Tab):

To prevent accidental erasure of important data, slide the disk's write-protect tab to the "protect" position (tab open). If you attempt to modify the disk when the write-protect tab is set to "on" position, "Prot (Protected)" will appear on the LED display in the M.D.R. section indicating that the operation is not possible.

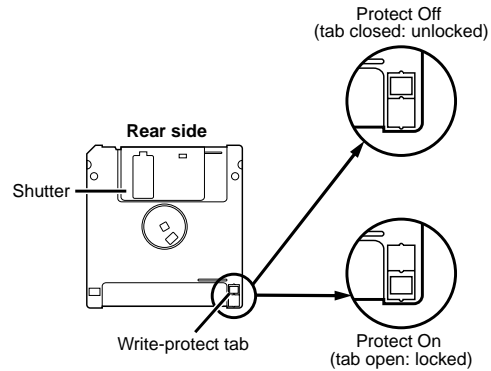

■ Data backup

For maximum data security Yamaha recommends that you keep two copies of important data on separate floppy disks. This gives you a backup if one disk is lost or damaged. To make a backup disk use the Disk Copy function on page 103.

Improved Potentiality of the M.D.R.

The M.D.R. of the EL-700/500 begins reading all data as soon as you insert a disk into the floppy disk slot. Thus, inserting a disk causes to produce a sound (reading sound) indicating that the M.D.R. is in the reading process.

The improvement of the M.D.R. allows you to start song playback immediately, to be free from the reading sound during playback and to record the song playback using the several song numbers with the Next Song function.



Ejecting the disk will lose the data loaded from the disk except for the currently selected and played back song.



The time reading sound is produced is in proportion to the amount of data recorded in the disk. You can eject the disk whenever you are not using the M.D.R. and don't want to be bothered with the reading sound.

2 Formatting a Disk

Before recording a performance to your blank disk, the disk must first be formatted.

To format a disk:

1 Put the disk, label facing up, into the disk drive (floppy disk slot).
“Fort” will appear on the LED display indicating that the inserted disk requires to be formatted.

2 While holding down the SHIFT button, press the FORMAT button.
This step puts the format operation on stand-by, indicated by the dashes on the LED display and the flashing LED above the FORMAT button.

3 Press the FORMAT button again to begin formatting.
The LED above the FORMAT button stays lit. The number “160” appears on the LED display and counts down to “001” as the disk is being formatted. When formatting is completed, operation returns to the original STOP status.
The following Song Name display appears after the operation.

SONG NAME			PAGE: 1 · 2 · 3 · 4
1:	6:		UTIL.
2:	7:		CHANGE
3:	8:		NAME
4:	9:		
5:	10:		

The song numbers to be displayed at one time are 10. The page numbers, from 1 through 4, are also shown at the top right side of the display. A total of 40 song locations are created. The song names next to each song number are left blank and indicate that each song number doesn't contain any data.

About SHIFT button:

You will find the SHIFT button (printed in green) at the top right side of the M.D.R. section. Some buttons in the M.D.R. section have dual functions: the first function is printed in white above each button; the second function is printed in green below each button. The SHIFT button is used to select the second functions by pressing each function button while holding down the SHIFT.

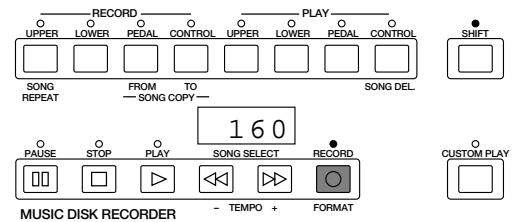
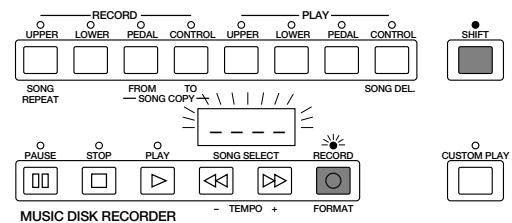
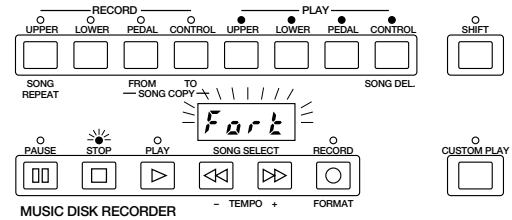

NOTE:

Selecting UTIL./Change Name allows you to change the song name you have recorded. See page 89 for the details.



If you format a disk that contains previously recorded data, all data on the disk will be erased. To avoid inadvertently formatting a disk before this step, press the STOP button.

3 Recording

1) To record a song:

1 Set the desired registrations on the Electone. Make all the Electone settings necessary for the song you will record. This means entering the all registrations you will need for the entire performance in the Registration Memory. Make sure also to select the registration that you will use at the beginning of the song.

2 Put a formatted disk into the disk slot.

3 Use the SONG SELECT (◀◀, ▶▶) buttons to select the song number for recording. You can also select the song number by pressing the Data Control buttons.

SONG NAME		PAGE: 1 · 2 · 3 · 4
1:	6:	UTIL.
2:	7:	CHANGE NAME
3:	8:	
4:	9:	
5:	10:	

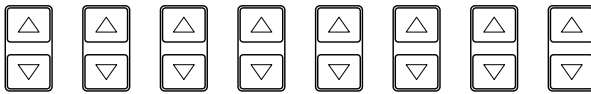

4 Press the RECORD button. The RECORD lamp lights up and the PLAY and CUSTOM PLAY lamps begins blinking, indicating that the Music Disk Recorder is ready to record.

5 Press the PLAY button. The PLAY lamp lights up and small bars flash across the LED display from left to right, indicating that the M.D.R. is reading the registrations and other settings.



NOTE:

The song numbers 01 through 40 are available and up to 40 songs can be stored on a disk. However, available song numbers may be reduced depending on the amount of the song data you have recorded. See page 105 for the information about the total amount of memory left on a floppy disk.

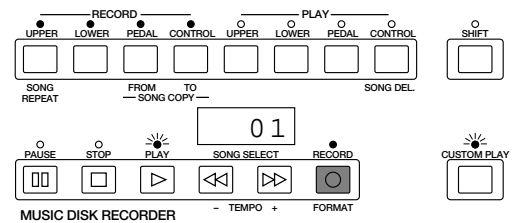
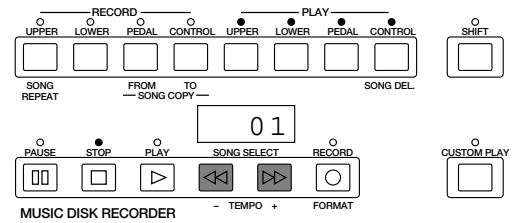

NOTE:

If the selected song number already contains recorded data, small bars (“--”) appear at the left part of LED display and flash along with the song number, warning you that the selected song number already contains recorded data. If you want to execute recording operation over the song number, press the RECORD button again. If you don't want, select another song number for recording or press the STOP button to cancel recording.

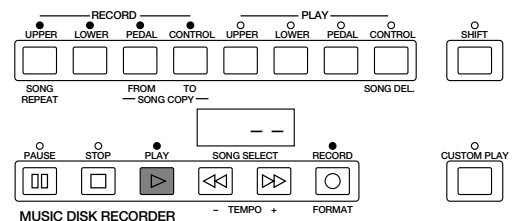

6 After numbers appear on the LED display of the M.D.R., begin playing. Once the setup operation in step #5 is complete, a number will appear on the LED display indicating that you can begin recording your performance. The number also indicates the amount of memory left on the disk.

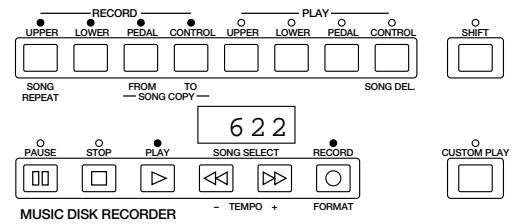

NOTE:

The short time it takes to set up for recording is recorded as well, causing a short pause before playback of the song.

If you make a mistake during recording:

1. Press the PLAY button while the M.D.R. is still running. This stops the recording and returns you to the starting point of the song. The letters "rE" (retry) appear on the left side of the LED display and the PLAY and CUSTOM PLAY LEDs start flashing, indicating that you can re-record the song.
2. Press PLAY again to begin re-recording the song. Re-recording starts from the beginning of the song and replaces the previously recorded performance with the newly recorded performance.

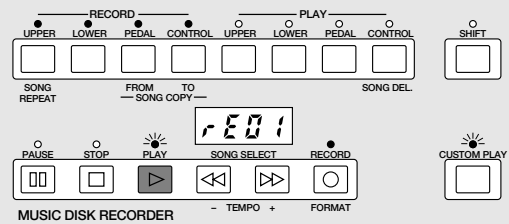

7 When you finish playing, press the STOP button. After the small bars flash to draw a square on the LED display to indicate the processing for stop, both the RECORD and PLAY lamps go out, and recording is stopped.

SONG NAME		PAGE: 1 2 3 4
1: SONG 1	6:	UTIL
2:	7:	CHANGE
3:	8:	NAME
4:	9:	
5:	10:	

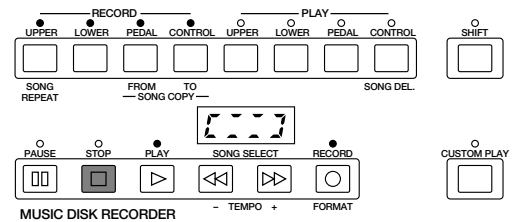

Never eject the floppy disk before the STOP lamp lights up.



NOTE:

When the available memory reaches "008" or less, the numbers begin flashing to warn you. If this happens, stop recording before the display reaches "000."

8 To hear your newly recorded performance, press the PLAY button. Play back will begin after a couple of seconds. For more information on playback and other playback-related functions, see page 95.



Never attempt to press the eject button or turn the power off during recording, reading and playing back. Doing so can damage the disk and possibly the disk drive. Be sure to remove the floppy disk from the disk drive before turning off the power.

Changing the Song Name

1. Press the top right Data Control button in the Song Name display.
“Edit Song Name” display appears, prompting you to edit the song name.

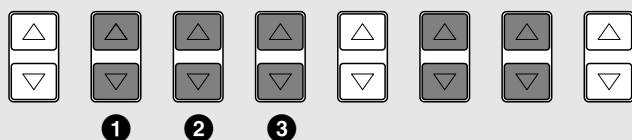
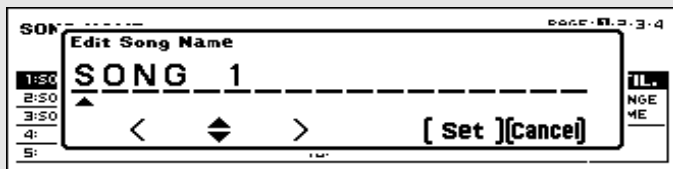

2. Select the letter, number or symbol you want to use by pressing the Data Control buttons corresponding to 2.
3. Press 3 (or 1) to move the cursor to the position at which you want to enter the letter, number or symbol.
4. Repeats the above steps 2. and 3. to complete your song name. Up to seventeen characters can be entered.
5. After finished, select [Set] to determine the name.

- ① < : Moves the cursor one step to the left.
- ② ▲▼ : Selects the letter, number or symbol at the current cursor position.
- ③ > : Moves the cursor one step to the right.



NOTE:

Pressing ① (③) while holding down the COARSE button moves the cursor to the far left (the far right). Pressing ② while holding down the COARSE button jumps to the top of each character group, upper case letters, lower case letters, numbers and symbols.

Available Letters, Numbers and Symbols

A	B	C	D	E	F	G	H	I	J	K	L	M	N	O	P	Q	R	S
T	U	V	W	X	Y	Z	a	b	c	d	e	f	g	h	i	j	k	l
m	n	o	p	q	r	s	t	u	v	w	x	y	z	0	1	2	3	4
5	6	7	8	9	!	"	#	\$	%	&	'	()	*	+	,	-	
.	/	:	;	<	=	>	?	@	[\]	^	_	`	{		}	~

* The names input using the lower case (small) letters will be displayed in the upper case letters, or the capital letters, with the EL-700/500. The small letters can be recognized and displayed on certain models like EL-900.

* Pressing ② while holding down the COARSE button jumps to the top of each character group (the characters in the double-squares).

Outline of M.D.R. Operation

Though the M.D.R. is as easy to operate as a cassette tape recorder, it is far more versatile. Since it records all Electone settings and control movements as well as the notes you play as digital data, it allows you much more flexibility and control than even the most sophisticated tape recorder. Basically, the M.D.R. independently records the following three types of data:

1. Registration data (including Bulk data)

All registrations stored to the Registration Memory numbered buttons as well as the registration currently set to the panel, are recorded at the beginning of a song, before the actual recording of your performance. Bulk data is also saved to the song with the Registration data. Bulk data includes: Registration Shift settings, Rhythm Pattern (User rhythms) and Rhythm Sequence data, and User voices.

2. Performance data

The M.D.R. records your performance on the keyboards and pedalboard of the Electone exactly as you play it, even recording the strength at which you play the keys and how hard you press them down while playing. The various types of performance data—Upper, Lower, Pedal and Lead—are recorded to independent “tracks,” so that you can change any one of them without affecting the others.

3. Control data

All changes you make on the Electone during your performance are recorded in real time. These include registration changes, the use of the expression pedals, footswitches and knee lever.

2) To record each part separately:

You can also record the parts of your performance independently; for example, first recording the chords and bass to the song (using the Lower and Pedalboard), and after that recording the melody (using the Upper Keyboard). This function also lets you record the lead voice, keyboard percussion and performance control data, such as registration changes and expression pedal operation, separately from the other parts of the song.

1 Set up the M.D.R. for recording, as you did in the section above.
The first steps in recording parts separately are the same as for normal recording on page 87:

1. Memorize all the registrations needed for your performance to the Registration Memory numbered buttons, and set the registration that will be used at the beginning of the song.
2. Insert a formatted disk.
3. Select the song number to which you will record your performance.
4. Press the RECORD button to make the Music Disk Recorder ready to record.

2 Select the parts for recording.
Pressing the RECORD in the procedure 1-4. above turns on the all parts' LEDs in the upper left row indicating that each part is ready to record. Press the RECORD buttons for each part in the upper left row to turn off the parts you don't want to record. For this example, press RECORD/UPPER. The PLAY/UPPER lamp in the upper right row lights up.

■ RECORD/UPPER

Records the performance data of the Upper keyboard when turned on.

■ RECORD/LOWER

Records the performance data of the Lower keyboard when turned on.

■ RECORD/PEDAL

Records the performance data of the Pedalboard when turned on.

■ RECORD/CONTROL

Records the Control data (see Outline of M.D.R. Operation in the previous page) when turned on. The LED lamps above the buttons indicate the record status of the parts.
This example operation disables recording of the Upper part.

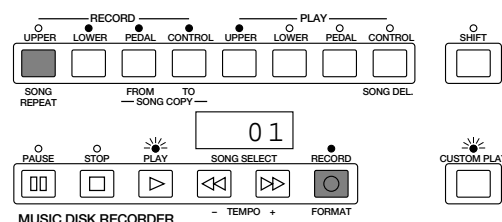

Separate recording for Lead Voice and/or Keyboard Percussion parts:

Hold down the SHIFT button and simultaneously press the appropriate button in the top row in the procedure #2. above. The two buttons (indicated in the illustration at the right) function as Lead Voice and Keyboard Percussion selectors in the record mode.

■ **RECORD/LEAD**

Records the performance data of the Lead Voice voice when turned on.

■ **RECORD/K.PERC.**

Records the performance data of Keyboard Percussion when turned on. (Keyboard Percussion can be recorded and played independent of the Rhythm patterns.)

Holding down the SHIFT button in the record condition lets you select these “hidden” functions. The lamps above each button will also change to indicate the status of SHIFT-selected parts.

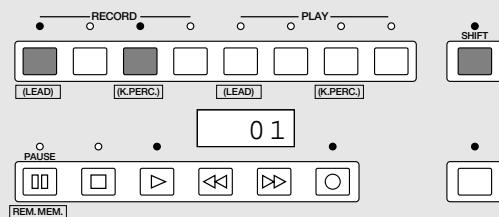

NOTE:

If you don't record the Lead Voice and Keyboard Percussion parts separately, the Lead part will be recorded as the Upper data and the Keyboard Percussion part will be recorded as the Lower/Pedal data.

3 Press the PLAY button, and start playing after numbers appear in the display. For this example, play the lower keyboard and pedalboard.

4 Press the STOP button when you are finished with your performance to stop recording. Now that you've recorded the first parts of your performance.

5 Press the RECORD button to set up recording of the next part. In this case, the song (number) contains the performance data of the Lower and Pedal in addition to the registration and setup data. The small bars (“--”) appear at the left part of LED display and flash along with the song number, warning you that the selected song number already contains recorded data.

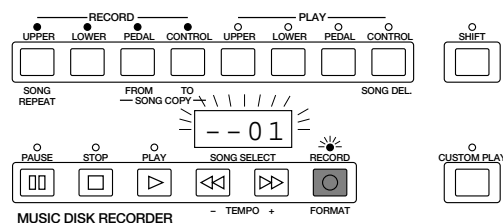

6 Press the RECORD button again to record another part (Upper part). The RECORD lamp lights up and the PLAY and CUSTOM PLAY lamps begins blinking, indicating that the Music Disk Recorder is ready to record.

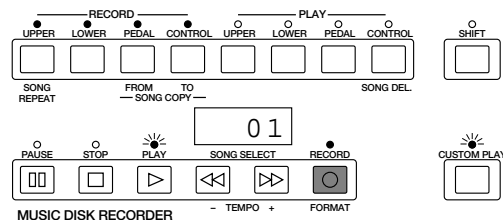

7 Press the RECORD buttons for each part in the upper left row to turn off the parts you have already recorded. In this case, press RECORD/LOWER, RECORD/PEDAL and RECORD/CONTROL to turn them off.

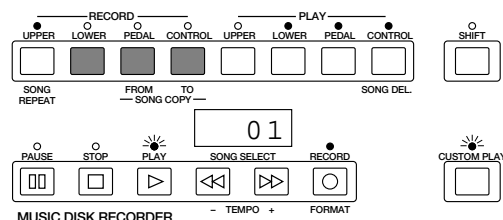

8

Press the CUSTOM PLAY button to start recording of the new part or parts (Upper part).

Playback of the previously recorded parts starts immediately.

The CUSTOM PLAY button is used here to record only the parts that have been selected for recording, and play back only those parts that have been selected for playback. Since registration data has already been recorded with the first parts of the song, recording begins immediately.

While you listen to the parts being played back, start playing the melody on the Upper keyboard.

When the end of the recorded performance is reached, playback is automatically stopped and the STOP status is resumed.

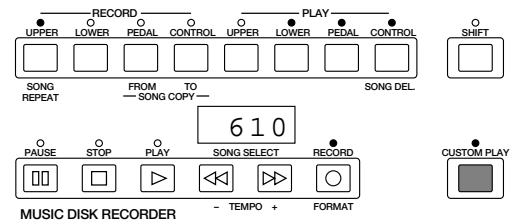

The CUSTOM PLAY button is used to record or play back the parts and data other than the registration data.



The length of a subsequently recorded part cannot exceed the length of the previously recorded parts. If you want to change the song length, first delete the existing song (see Song Delete on page 103) and record again.

Punch-in Recording

You can retry to change a specific part which you don't want to use.

To execute the Punch-in recording:

1. Press the PLAY button to start playback of the song which contains the part you want to change.
2. Press the PAUSE button at the point you want to execute punch-in recording.
3. Press the RECORD button. The PLAY and CUSTOM PLAY lamps begins blinking, indicating that the Music Disk Recorder is ready to record.
4. Press the RECORD buttons for each part in the upper left row to turn off the parts you want to keep as they are. (Only the part you want to do punch-in recording should be turned on.)
5. Press the PLAY button to start punch-in recording. Play the specified range you want to change.
6. Press the STOP button to quit the Punch-in recording function as soon as you reach the end of the range.

7

4 Recording Registrations (and Bulk Data)

You can also record registrations by themselves, without recording a performance. Bulk data, including Registration Memory and Registration Shift settings, Rhythm Pattern (User rhythms) and Rhythm Sequence data, and User voices, are also saved in the operation. There are two ways to record the registrations and bulk data:

[1] To record only the registrations and bulk data:

- 1 On the Electone, set the registrations and all other data you want to record.
- 2 Select the song number to which you wish to record the registrations.
- 3 While holding down the RECORD button, press the M./TO DISK (Memory) button on the Registration Memory panel. Small bars flash across the LED display from left to right, indicating that the M.D.R. is reading the registrations and other settings. After recording, the M.D.R. is automatically stopped and returns to STOP status.

2. Press the M./TO DISK (Memory) button.



EL-700

[2] To record only the registrations and bulk data:

- 1 Set up the registrations and select the song number as you did in steps #1 and #2 above.
- 2 Press the RECORD button to make the M.D.R. ready to record.
- 3 Press the PLAY button to record the registrations, then press the STOP button as soon as you see the small bars flash across the LED display from left to right. The small bars that flash across the display indicate that the M.D.R. is recording the registrations and being set up for normal recording; pressing the STOP button interrupts this process.

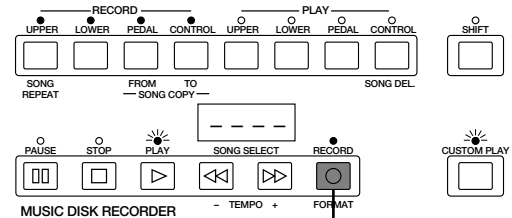

1. While holding down the RECORD button...

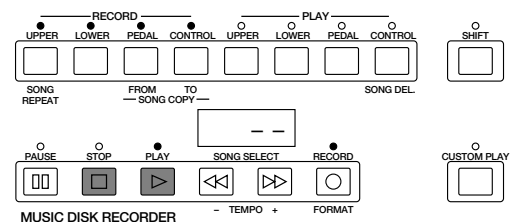
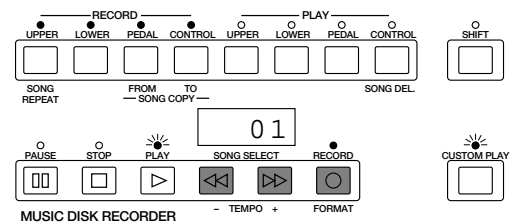

5 Recalling Recorded Registrations (and Bulk Data)

The registrations (and bulk data) recorded to song numbers in the above operation can be loaded back to the Electone by simply selecting the appropriate song number and pressing the PLAY button. When the operation has been completed, the M.D.R. returns to STOP status.

The M.D.R. also makes it possible to use more than the 16 Registration Memory registrations (eight for the EL-500) in a performance—without having to alter the current panel settings. This would come in handy when performing several songs in succession that use more than 16 registrations (eight for the EL-500).

To do this:

- 1 First record the registrations you need into several song numbers on the M.D.R. before the performance. (You should also try to record them in the order that you'll use them, if possible.)
- 2 During the performance, after all 16 registrations (eight for the EL-500) from a certain song number have been used, select the next song number and press the PLAY button on the M.D.R. This replaces all 16 registrations (eight for the EL-500) in Registration Memory with the new ones from the selected song number.
- 3 By repeating the above steps, you can run through an entire performance without having to change the panel settings.



NOTE:

Selecting the Next Song in the User Registration Shift settings makes it possible to have the M.D.R. automatically read the 16 registrations (eight for the EL-500) in the next song number. See page 81 for more information.

6 Replacing Registrations

The M.D.R. also lets you change the registrations of an existing song without changing the performance data. The procedure is the same as that of Recording Registrations mentioned in the previous page.

7 Playback

You can play back your recorded performance by simply pressing the PLAY button. Registrations and other data will be recalled to the Electone.

1) To play back a song:

1 Select the number of the song you want to play back by using the SONG SELECT buttons. You can also select the song by pressing the Data Control buttons.

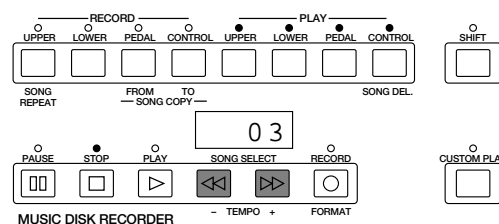

2 Press the PLAY button. The PLAY lamp lights up and small bars move across the display, indicating that the M.D.R. is resetting registrations on the Electone.

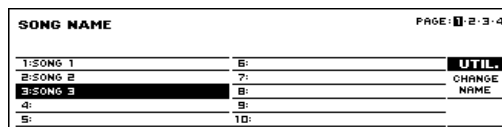

Playback of the song begins after the Electone data is reset and the song time is shown on the M.D.R.'s display.

Playback automatically stops at the end of a song. You can, however, stop playback in the middle of a song by pressing the STOP button.

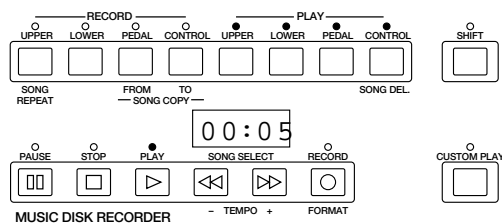
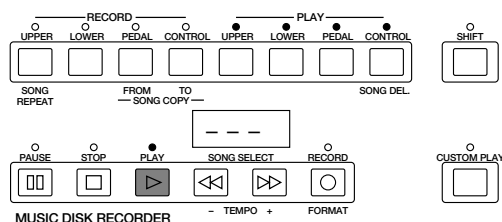

If you have recorded the Lead Voice/Keyboard Percussion part separately:

On the EL-700/500 the Lead/Keyboard Percussion part(s) you have recorded separately will automatically be on when you start playback.



When you play back the data which is made by other Electone models such as EL-90/87 and which includes the separately recorded Lead/Keyboard Percussion part(s), Lead part will be off and Keyboard Percussion will be on as the defaults. (To turn on the Lead part, press UPPER/PLAY while holding down the SHIFT.)

2) To play back the selected part(s):

You can also play back the selected parts of your recorded performance, while other parts are temporarily turned off. This function is especially useful for playing a single part, such as the melody, over previously recorded accompaniment parts.

To select specific parts for playback:

- 1 Select the number of the song to be played back.
- 2 Set the parts you wish to mute to off, by pressing the appropriate PLAY button in the upper right row. The LED of the selected part should be off. Make sure to turn on the parts you wish to play back.



Never turn off the power switch when a floppy disk is still engaged in the M.D.R. disk slot. Also do not press the Eject button during recording or playback.

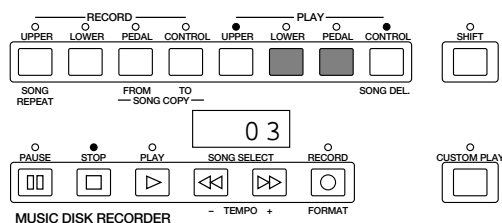

3 Press the PLAY button.
First the registration and other data are read, then playback of the performance starts (excepting the parts that were turned off in step #2).

4 Now perform your new part or parts over the playback parts.
When the end of the recorded performance is reached, playback is automatically stopped and the STOP status is resumed.

3) To repeat playback of a song or songs:

This feature allows you to repeatedly play back either all songs on a disk or only one specific song.

1 Select the song number you wish to play back.
If you wish to play back all songs on a disk, select the first song that will be played back. The others will follow in order.

2 SHold down the SHIFT button and simultaneously press the SONG REPEAT button.
The lamps above SHIFT and SONG REPEAT light up, and "ALL" appears on the LED display.

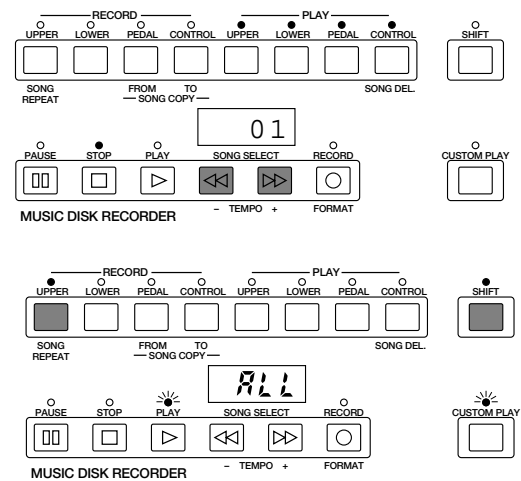

3 To repeatedly playback all songs starting with the selected song:
Press the PLAY button.
Playback will begin from the song selected and repeat indefinitely. To stop playback, press the STOP button.

3 To repeatedly play back only the selected song:

1. Again hold down the SHIFT button and simultaneously press the SONG REPEAT button.
"SinG" appears on the LED display to indicate that a single song will be repeatedly played back.
2. Press the PLAY button to begin playback of the song.
Playback will begin from the song selected and repeat indefinitely.

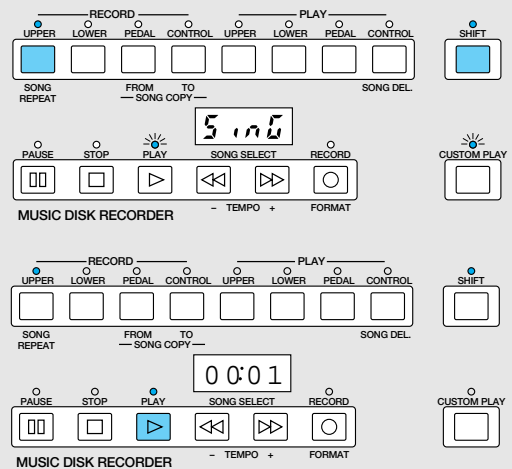

To stop playback, press the STOP button.

About XG

The EL-700/500 allows you to play back the commercially available XG song data using the M.D.R. Also, the XG Easy Converter function of the EL-700/500 lets you convert the data created with the EL-700/500 to the XG compatible data.

Playing back the XG Song Data

This function is for playback only. You can practice a specific part of the XG song data by muting that part.

To play back XG song data:

1. Insert the XG song disk into the floppy disk slot.

The following display appears.

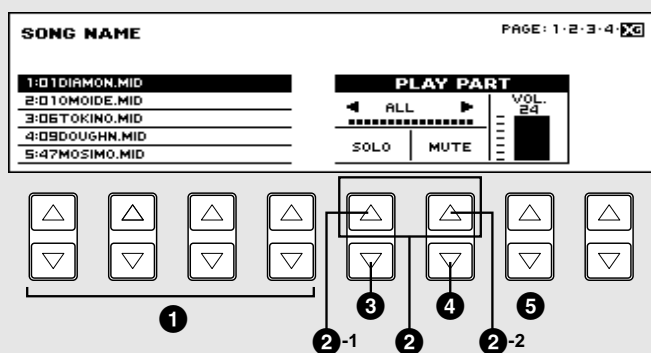

[XG] page will be added to the upper right side of the display.

The XG song data will be displayed on the XG page.

You can store both the XG songs (on the XG page) and Electone songs (on pages 1 - 4) in a single disk.

2. Use the Data Control buttons **1** to select a song which you want to play back.
3. Press the PLAY button in the M.D.R. section to start songplayback.
Use **2** button to select a part, and press **3** to engage the solo playback of the selected part, press **4** to mute some parts or press **5** buttons to adjust the volume of a specific part.

- 1 Selects a song.
- 2 Selects a part. Range: 1 - 16, ALL (all parts)
 - 2-1 Moves the cursor one step to the left.
 - 2-2 Moves the cursor one step to the right.
- 3 **SOLO**: Brings the part at the current cursor position to solo playback status. The solo playback part is indicated by a square (□). All other parts will be muted automatically.
- 4 **MUTE**: Brings the part at the current cursor position to muted status. The muted parts are indicated by a hyphen (-).
- 5 **VOL. (VOLUME)**: Adjusts the volume of each part within the range, 0 - 24. If you have selected ALL, you can adjust overall volume.



NOTE:

The XG song data created with EL-700/500 conforms to the SMF format 0 and 1.

XG Easy Convertor

This function allows you to convert the EL-700/500 song data to the XG format data. You can then play back the data using XG devices and/or personal computer.

Depending on the type of XG devices, sound may be different from the original data you created.

The contents to be converted:

Voice (Program) number, Volume, Feet (octave settings), Pan, Vibrato, Slide (for the Lead voices), Initial Touch, Pitch Bend, Effects (Tremolo and Delay), Reverb (except for Length), Sustain, Rhythm Patterns (except for Accompaniment), Expression, Registration, Registration Shift (except for Next Song)

To convert the EL-700/500 data to the XG song data:

1. Insert the disk containing the Electone data into the floppy disk slot.
2. Select the song to be converted to the XG data.
3. While holding down the bottom right Data Control button (nothing is displayed in the corresponding section of the LCD display) press the RECORD button in the M.D.R. section.

The following message appears to confirm the operation.

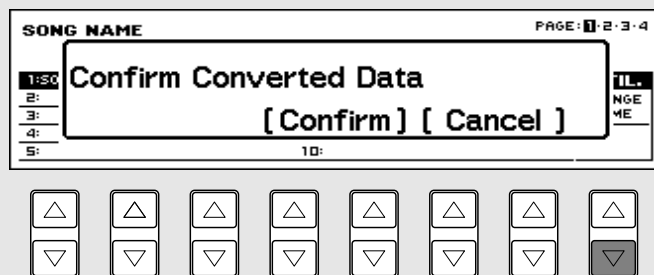

4. Press the Data Control buttons corresponding to [Confirm].

The M.D.R. starts playback of the selected song for you to decide whether you convert it to the XG data, or not. After finishing playback the following message appears.

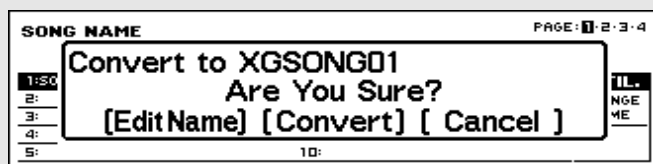

5. Press the Data Control buttons corresponding to [Convert].

After the process of the conversion the LCD returns to the original display.

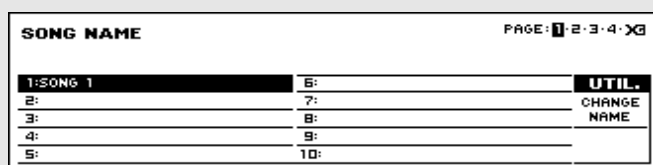

When the XG song data is newly created in the disk, XG page will be added to the top right side of the display. The converted song (XG data) will be stored on the XG page and the original song (Electone data) is left as is.



NOTE:

Confirm that the disk should contain enough amount of available memory before the conversion.

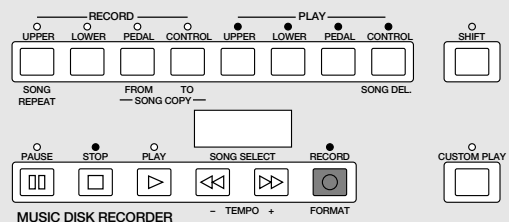

NOTE:

In this case the M.D.R. uses the XG tone generator built in the EL-700/500 to play back the song.



NOTE:

Select [Cancel] to abort the operation and return to the original display. Select [Edit Name] to jump to the Edit Song Name display (page 89). You can name the XG song using up to eight letters.



NOTE:

The converted XG song data may sound differently from the original data.



NOTE:

The converted data cannot be deleted.

8 Other Functions

1) Custom Play

If you want to play back the song without resetting the registrations and other data, press the CUSTOM PLAY button. This displays the song time and starts playback immediately.

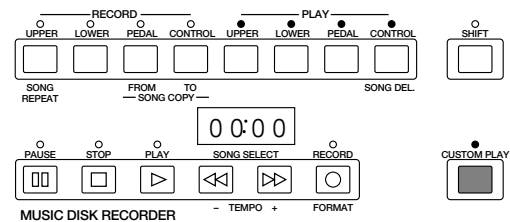

NOTE:

If you hold down the SHIFT and press CUSTOM PLAY or if you execute the following Read and Auto Increment function, all data, except for that of Rhythm Pattern Program, Rhythm Sequence, User voices, Keyboard Percussion assignments and Instrument (rhythm) settings, will be loaded and played back.

2) Read and Auto Increment

Another method for calling up only registration data, besides that mentioned in the Note above, is to press the UPPER button in the RECORD section while the M.D.R. is in the Stop status. This Read and Auto Increment function automatically calls up the registration data and selects the next song number.

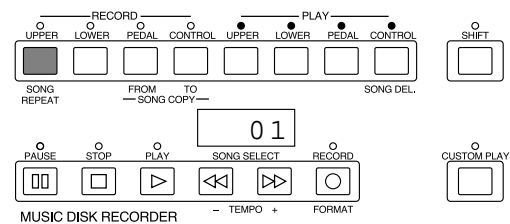

NOTE:

This function is not possible if the next song contains no registration data.

3) Pause

If you want to temporarily stop playback of the song or songs, press the PAUSE button. To resume playback from the point at which the song was paused, press the PAUSE button again.

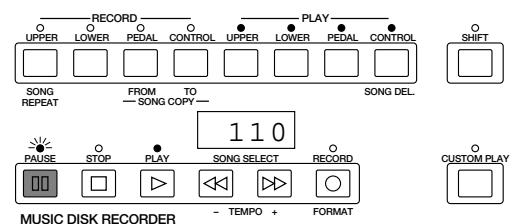

NOTE:

It may take some time to search the point at which you want to resume playback when you return to an earlier position using the fast reverse function.

4) Fast Forward and Fast Reverse

During playback, these buttons function as fast forward and fast reverse buttons, much like those of a tape recorder. Press >>> to advance to a later point in the song or press <<< to return to an earlier position. While either of these buttons is held down, playback stops and the song time is advanced or reversed accordingly. Hold down the button until the desired song time is shown. When the button is released, playback is paused. To resume playback from the point you've advanced or reversed to, press the PLAY button.



NOTE:

Fast Forward and Fast Reverse operate at five times the normal playback speed.

5) Changing the Tempo

You can change the tempo of the song as the song is playing on the M.D.R. by holding down the SHIFT button and pressing the TEMPO + or TEMPO - button. (The Tempo dial on the Electone panel cannot be used to change the tempo on the Music Disk Recorder.)

Each press of the button slows down or speeds up the tempo by a small amount. Changing the tempo does not change the pitch of the music.

To restore the original recording tempo of a song, hold down the SHIFT button and simultaneously press both TEMPO buttons.



Indicates faster tempo



Indicates original tempo



Indicates slower tempo

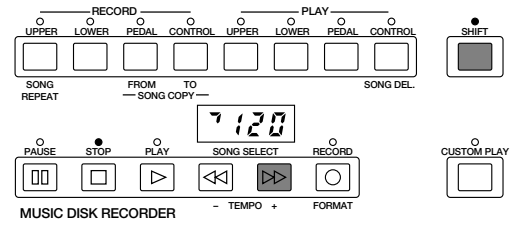

NOTE:

When tempo is changed, the LED display indicates the change as a percentage of the original recorded tempo (100). Values less than 100 indicate a slower tempo; values greater than 100 indicate a faster tempo.

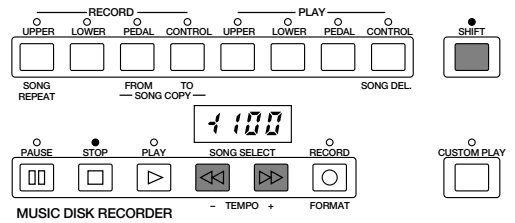

NOTE:

Tempo changes remain in effect even through changes in song number. If you have changed the tempo in one song, you should perform the above step to restore the original tempo before playing another song. Turning the power switch off and on again also restores the original tempo.

6) Song Copy

This function lets you copy the data recorded at one song number to another song number. You can copy and exchange the data even between two different disks.

To use the Song Copy function within a disk:

- 1 Select the song number to be copied (source) with the SONG SELECT buttons.
- 2 While holding down the SHIFT button, press the SONG COPY FROM button.
The song number to be copied from appears at the left of the LED display.
- 3 While holding down the SHIFT button, press the SONG COPY TO button.
The M.D.R. automatically searches for an empty song number to copy the data to, and displays that number at the right side of the display. The RECORD lamp will start flashing indicating that the M.D.R. is ready to copy. If all songs numbers contain recorded data, "FULL" appears on the LED display. In this case, you should erase one of the songs on the disk by using the Song Delete function (page 103).
- 4 Use the SONG SELECT buttons to select a destination song number for copying.
Follow this step if you wish to select a different destination song number than the one displayed. The M.D.R. will display only those song numbers that have no data.
- 5 Press the RECORD button to execute the Song Copy function.
The RECORD lamp stops flashing and remains lit, indicating that the Song Copy function is in process. The LED display shows the "size" of the song in numbers, and counts down as the data is being copied. When the display shows "000," the song has been completely copied.



NOTE:

This function is available with the Electone data, not with the XG data.

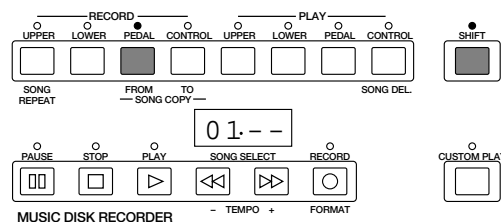

NOTE:

If the specified song number has no recorded data, the M.D.R. automatically searches for and selects the next song that contains recorded data.

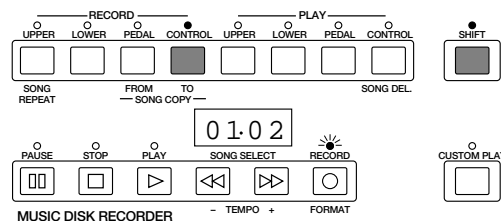

NOTE:

The message "FULL" may appear when the available memory is short.



NOTE:

If you want to abort the operation, press STOP button.

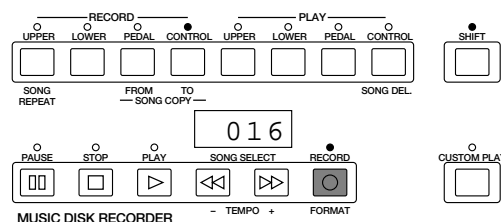

To use the Song Copy function between two different disks:

- 1 Insert the source disk that contains the song you want to copy to.
- 2 While holding down the SHIFT button, press the SONG COPY FROM button.
The song number to be copied from appears at the left of the LED display.
- 3 Select the song number to be copied (source) with the SONG SELECT buttons.
- 4 Press the RECORD button.
The RECORD lamp lights up and the LED continues to indicate "00.--" as shown at the right.
- 5 Press the Eject button to take out the source disk.
- 6 Insert the destination disk to which you want to copy .
- 7 While holding down the SHIFT button, press the SONG COPY TO button.
The M.D.R. automatically searches for an empty song number to copy the data to, and displays that number at the right side of the display.
- 8 Use the SONG SELECT buttons to select a destination song number for copying.
- 9 Press the RECORD button to execute the Song Copy function.
The LED display shows the "size" of the song in numbers, and counts down as the data is being copied. When the display shows "000," the song has been completely copied.

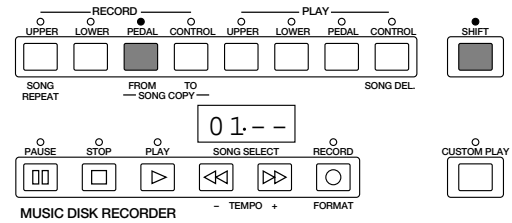

NOTE:

You can also use the Data Control buttons to select the song number.

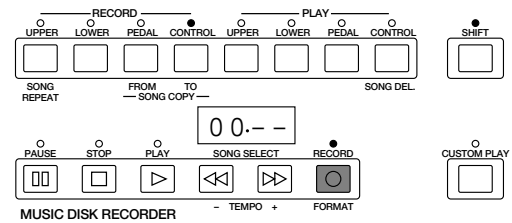

NOTE:

Although ejecting the disk while the RECORD lamp is lit is prohibited, you are allowed to eject the disk in this case.

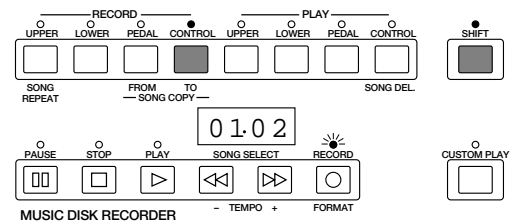

NOTE:

An asterisk (*) is added to the end of the (destination) song's name to differentiate from the original (source) song.

7) Song Delete

You can delete a song on disk by performing this function.

To use Song Delete:

- 1 Use the SONG SELECT buttons to select the number of the song you wish to delete.
- 2 While holding down the SHIFT button, press the SONG DEL. button.

The letters “dL” appear on the left side of the LED display, next to the selected song number. RECORD lamp flashes to indicate that the M.D.R. is ready to delete the song. If you wish to, you can still select a different song number in this step by using the SONG SELECT buttons.

- 3 Press the RECORD button to execute the Song Delete function.
The RECORD lamp stops flashing and remains lit, indicating that the Song Delete function has begun. When the Song Delete function is completed, the STOP status is automatically resumed.

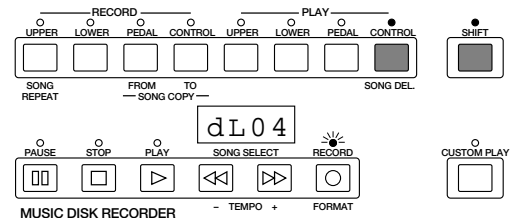

NOTE:

If you want to abort the operation, press STOP button.



NOTE:

XG song data cannot be deleted.

8) Disk Copy

You can duplicate a floppy disk by copying the contents. Yamaha recommends that you keep two copies of important data on separate floppy disks by using this function.

- 1 Prepare the source disk and the formatted blank disk to be copied.

- 2 While holding down the SHIFT button, press the LOWER button in the RECORD part.
“In 1” appears on the LED display to indicate that the M.D.R. is ready to execute the Disk Copy.



The disk type of both source disk and destination disk must be the same. For example, use 2DD for the disk to be copied (destination) if the source disk is 2DD type.



Be sure to set the Write-protect tab on the source disk to ON. On the contrary, set the Write-protect tab on the destination disk to OFF. The message “Prot” may appear if you insert the destination disk with the Write-protect tab ON. In this case, the Disk Copy function cannot be executed.

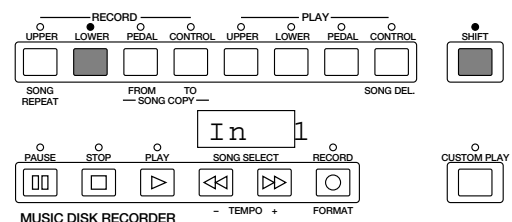

- 3** Insert the source disk into the disk slot.
The M.D.R. starts reading the data in the source disk.
“out 1” appears on the LED display.

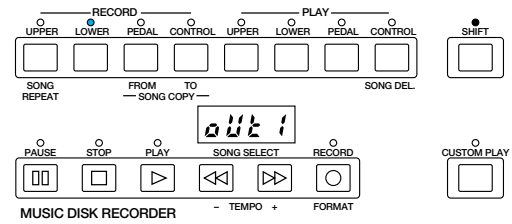

- 4** Press the eject button to take out the source disk.
“In 2” appears on the LED display to urge you to insert the destination disk.

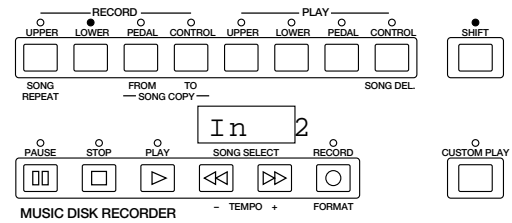

- 5** Insert the destination disk.
The number “160” appears on the LED display and counting down is initiated as the disk is being copied.

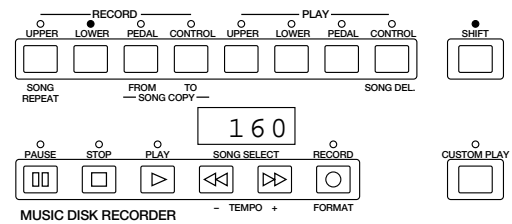

When finished, “End” will appear on the LCD display for few seconds.

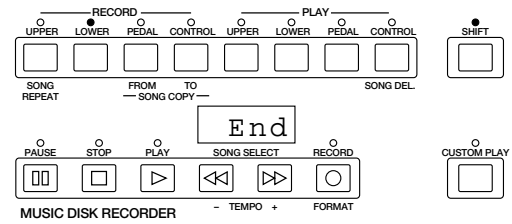

 **NOTE:**

“Fort” or “bAd” may appear if an error occur in the middle of the operation. If this happen, please retry formatting the destination disk and copying disk.



Follow the M.D.R. direction to eject/insert the disks during the operation. Do not eject/insert the disks frivolously ignoring the M.D.R. direction. Doing so can damage the disk and possibly the disk drive.

9) Checking the Remaining Memory

While playback is stopped, you can check the amount of memory available for additional recording in your disk. To do this, simultaneously hold down the SHIFT button and the PAUSE button (indicated in the illustration at right as REM. MEM.: Remaining Memory). The maximum amount of memory is ca.700 for 2DD disks and ca.1400 for 2HD disks.

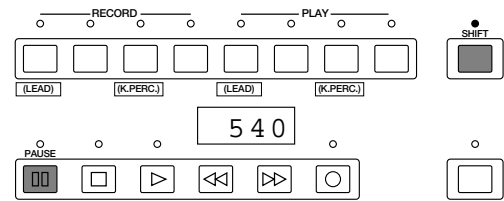

10) Voice Disks and Pattern Disks

The M.D.R. also allows you to select voices and rhythms from disks. For more information about Voice Disks, see page 118; for more on Pattern Disks, see page 143.

11) Copy Protect

Some of the Disks available for the Electone are purposely protected from being copied or erased. You cannot save the data to another floppy disk. If you try to load data from such a "copy-protected" disk to the Electone, a "Protected Disk" (PrXX*) message will appear on the LED display. The data cannot be saved to the disk.

*XX: song number

Messages on the M.D.R. LED Display

Display	Description of the Messages
<i>Inst</i>	No disk is installed. Install a disk.
<i>Prot</i>	1) The installed disk is write-protected, so the Record, Song Copy, and Song Delete jobs cannot be performed. Set the disk's Write-protect tab (page 85) to OFF. 2) If you are using a copy-protected playback-only disk, this message may appear when you attempt the Record, Song Copy, or Song Delete operations. 3) When executing Disk Copy, set the Write-protect tab on the source disk to ON.
<i>Formt</i>	The installed disk is not formatted. Format the disk. (page 86)
<i>FULL</i>	1) The disk's memory capacity is full, so the Record or Song Copy operation cannot be performed. Use another formatted disk. 2) Data is already recorded at all song numbers, so the Song Copy operation cannot be performed. Press the STOP button, then delete any unnecessary songs.
<i>EMPTY</i>	None of the song numbers contain recorded data, so the Song Copy operation cannot be performed. Press the STOP button.
<i>-out</i>	An error occurred because the disk was removed during recording or playback. Press the STOP button, and replace the disk, then start the operation over again.
<i>disc</i>	The installed disk cannot be played back on the M.D.R. Press the STOP button, then insert a compatible disk.
<i>lots</i>	Recording cannot be performed because too much data was received at once. Press the STOP button.
<i>bad</i>	The disk is defective and cannot be formatted. Press the STOP button, then insert another disk.
<i>Error</i>	An error occurred during the transmission or reception of data. Press the STOP button.
<i>--XX</i>	You are trying to record to the song number which already contains recorded data. Select the other blank song number by pressing the SONG SELECT buttons. * "XX" indicates a song number (01 through 40).
<i>PrXX</i>	When you insert the "copy-protected" disk to the Electone, this message will appear on the LED display. You cannot overwrite or save the changes. * "XX" indicates a song number (01 through 40).
<i>oooo</i>	This message indicates that an incompatible disk is inserted in the Voice Disk, Pattern Disk or Registration Menu Disk operation.
<i>_XX*</i>	An under line (_) before the song number indicates that it is XG song data. * "XX" indicates a song number (01 through 40).
<i>2hd</i> (or <i>2dd</i>)	You have inserted a wrong type disk as the destination disk in the Disk Copy operation. Use the same type disk as the source disk.

The EL-700/500 Electone has a Voice Edit feature that allows you to create your own voices. The Voice Edit uses sophisticated sound shaping tools that make it possible to craft just about any kind of sound—from authentic recreations of acoustic instruments to wild electronic voices and special effects. The following section will introduce you to the basics of voice editing by taking you step by step through a specific editing example. As you follow the steps, you may find many of the terms and parameter names to be unfamiliar. Once you go through the editing steps, however, we suggest that you read through the Voice Editing Basics section (page 116) to get a firmer understanding of the principles behind voice editing.

1 Editing a Voice

1) To select a voice and its Operator:

1 First, select the voice you want to edit from the Voice Menu. (Each volume on the other voice sections should be set to MIN.)

2 While holding down the VOICE EDIT button in the DISPLAY SELECT section, press the Voice button corresponding to the voice you wish to edit. For this example, select Piano1 from the UPPER KEYBOARD VOICE 1 section.

1. While holding down VOICE EDIT button...

If you press VOICE EDIT without selecting a voice, the following display will prompt you to complete the step.

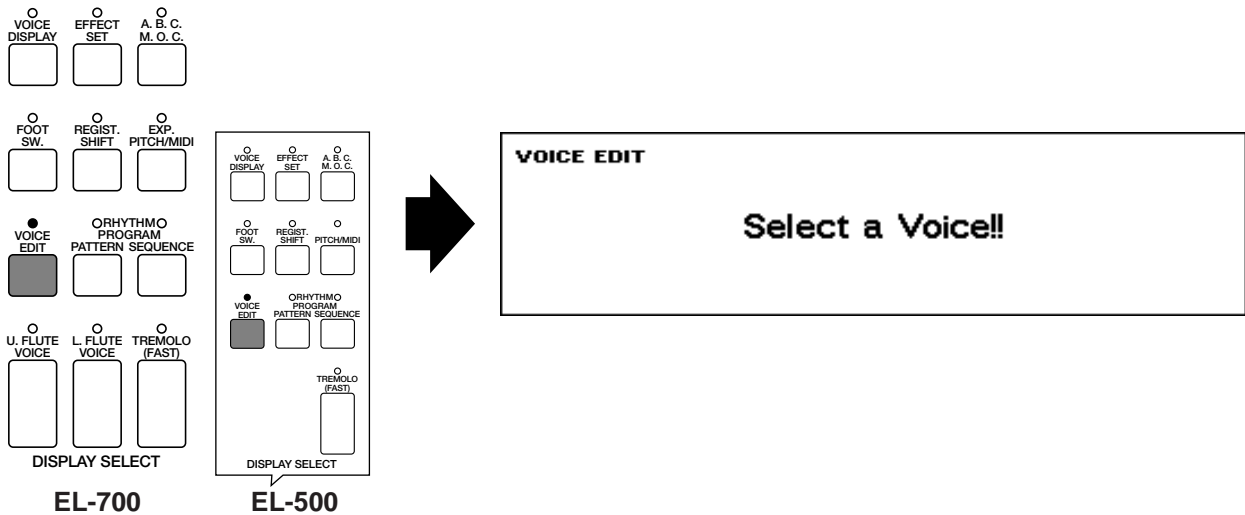

NOTE:

Only the AWM Voice Menu voices can be edited with the Voice Edit controls. The Flute voices on the EL-700 have their own editing controls and cannot be edited here.

2 ...press desired Voice button.

After you have selected a voice—Piano 1, in this example—the following LCD will appear.

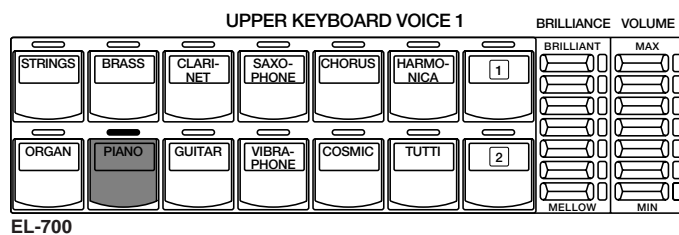

EL-700



NOTE:

The currently selected Operator name is shown in the dark bar in the middle of the display.

EDIT Page

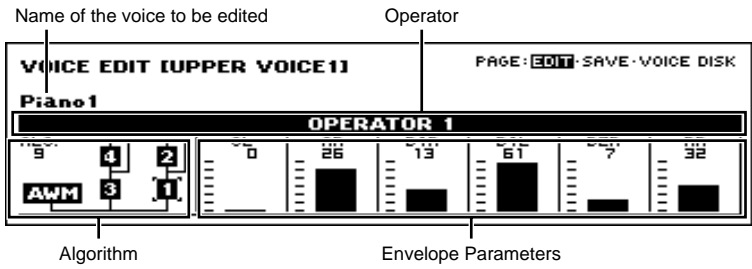

NOTE:

The Algorithm type used is different depending on the voices.

At the left side of the display is the Algorithm used for this voice. An algorithm is a kind of “map” that shows how the sound components of the voice are related to each other. Each voice has nine separate sound components and they are called “Operators,” AWM Operator and FM Operators 1 through 8.

3

Begin changing the sound by turning off all Operators, except Operator 1.

To turn off each Operator:

1. First, use the pair of Data Control buttons just below the algorithm display (below the box 1; the second from the left) to select an Operator.

The currently selected Operator number is surrounded by the “Brackets.”

Pressing the button move the “Brackets” counter clockwise, and pressing the button move the “Brackets” clockwise.

Move the “Brackets” to the Operator 2.

2. Then press one of the far left pair of Data Control buttons to turn the selected Operator off.



NOTE:

Although the Operators 5 through 8 are not shown in the same display, you can show them by moving the “Brackets” to the AWM operator or past the FM operator 4.

Reverse display (dark box) indicates that the Operator is on; normal display indicates the Operator is off.

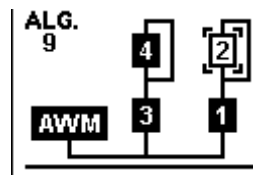

The “Brackets” indicate the currently selected Operator.

These buttons turn the selected Operator on and off.

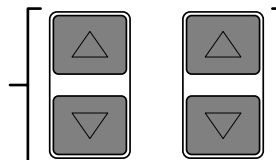

These buttons select the Operators in order.

3. Repeat the above process for all of the Operators except Operator 1. As you turn off each Operator, play the voice and listen to how the sound changes.B

2) To edit the FM Operators:

- Adjust the Envelope Parameters of Operator 1 (after turning off the other Operators).

The Envelope Parameters control the level of the sound and how that level changes over time. See page 119 for more information.

For now, try making some of these changes in the envelope:
Adjust the OL (Output Level) parameter.

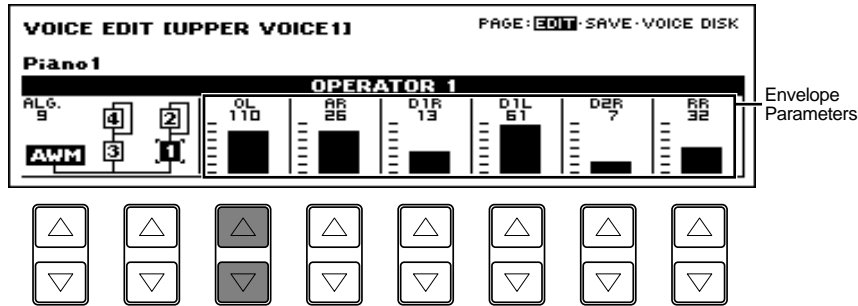

Changing the OL parameter affects the volume of the selected Operator.

Raise the OL parameter from 0 to 110 by using the pair of Data Control buttons just below the OL. (Pressing the ▲ button raises the level, and pressing the ▼ button lowers the level.)



NOTE:

The parameter value can be changed quickly when you press the Data Control button with the COARSE button held.

Adjust the AR (Attack Rate) parameter.

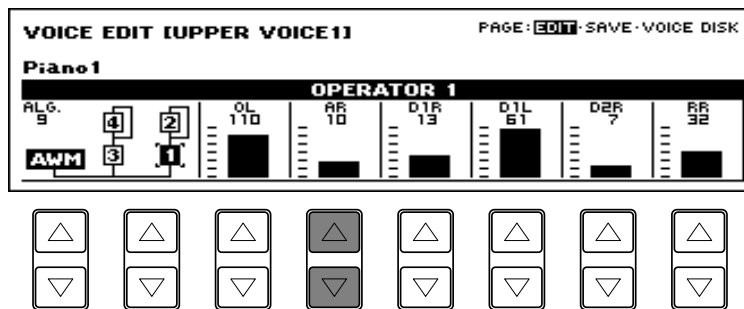

Play the voice and notice how the changes you make affect the initial volume of the voice. By changing this parameter you can make the sound gradually get louder (lower settings) or have it reach its full volume all at once (higher settings).

Adjust the RR (Release Rate) parameter.

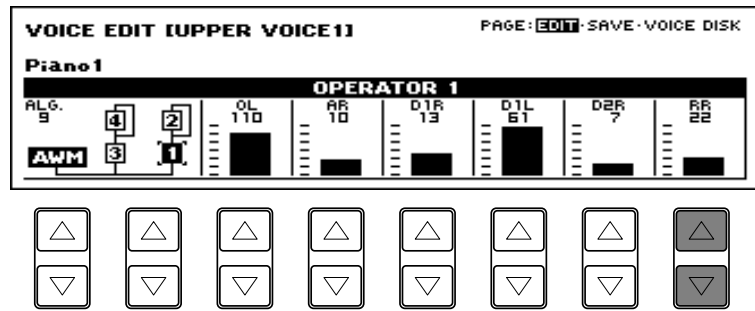

Play a note on the keyboard and then release it. Notice how the changes affect the tail end of the sound, just after you release the key. By changing this parameter, you can make the sound sustain beyond the release point (lower settings).

- 2** Keeping Operator 1 on, select and turn on Operator 2, then adjust the Operator level.

Adjust the OL (Output Level) parameter.

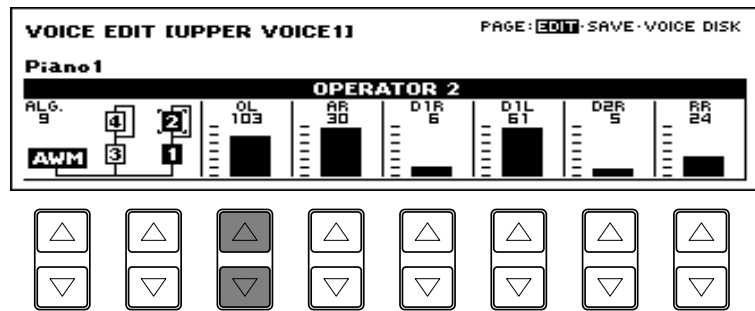

Use the Data Control buttons below OL (Output Level) to change the level of Operator 2. Notice that the volume of the sound doesn't change, but the tone does. Increasing the level of one of the top row Operators generally makes the tone of the Operator below it brighter or more metallic. Decreasing the level has the opposite effect.

- 3** Turn off Operators 1 and 2, and turn on Operators 3 and 4. Make some changes to their parameters, as you did with Operators 1 and 2 in steps #1 and #2 above. Set the OL of the Operator 3 to 110.



NOTE:

Raising the OL of the Operator 2 to make the sound brighter and lowering the AR of the Operator 2 can produce a distinctive effect.



NOTE:

No sound will be produced nor will adjusting the top row Operators have any effect if all of the bottom row Operators have been turned off or set to their minimum level. Be sure to turn on the bottom row of Operators and set them to a suitable level before changing the parameters of the top row Operators.

About the Operators

Changing the level of one of the top row Operators (2 and 4 here) affects the tone of the Operator below it.

Changing the level of one of the bottom row Operators (1 and 3) affects the volume of the related top row Operator.

3) To edit the AWM Operator:

Next, we'll make some changes in the sound of the AWM Operator. The AWM Operator is a specially recorded waveform with an actual instrumental sound, unlike the pure electronic sounds of the other Operators. Before you actually change it, try listening to this sound on its own, with the other eight Operators turned off.

- 1 Turn off all of the Operators, except for the AWM Operator. The AWM Operator has its own page with a different group of settings. The AWM Operator display appears as soon as the AWM Operator has been selected.

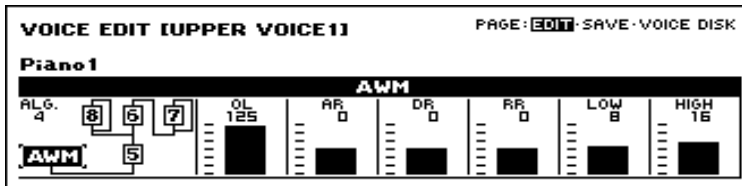

- 2 Adjust the LOW setting, and listen to how they affect the sound. Changing this parameter affects the lower range of the keyboard. Raising this parameter boosts the output of the lower range.

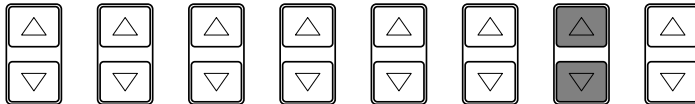
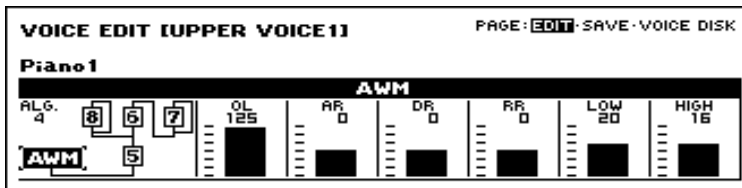

- 3 Adjust the HIGH setting, and listen to how they affect the sound. The higher setting results in a more pronounced and brighter sound in the higher range of the keyboard.

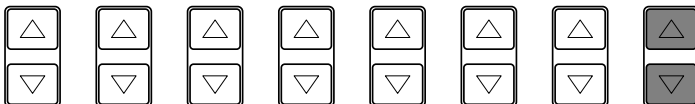
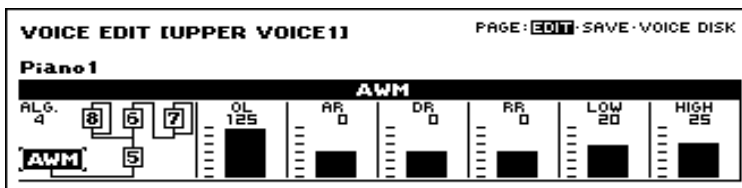

- 4 Finally, turn all of the other Operators back on and adjust each Operator's level.



LOW and HIGH are the equalizers exclusive to the AWM sounds.

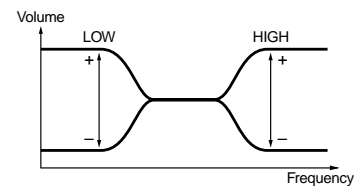



NOTE:

The Operator on/off settings you made here are temporary. Even though you turn off an Operator when editing a voice, the on/off status of the Operators will forcibly be changed and saved as “on” in a User voice.

If you want an Operator muted, set the OL parameter of the selected Operator to the minimum.



NOTE:

After making changes in the voice, you can restore the original voice by switching to another function. If, however, you wish to keep the newly created voice for future use, you should save it. (See following section.)

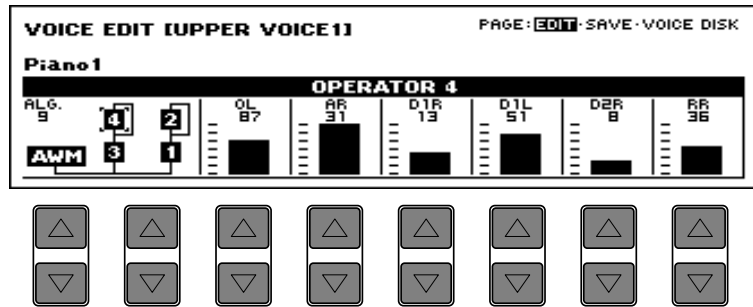

2 Saving Your New Voice

Once you have created a sound you are satisfied with, you'll want to save that sound for future use.

To save your newly created voice:

1

Use the Page buttons to select the SAVE page. The following display appears.

SAVE Page

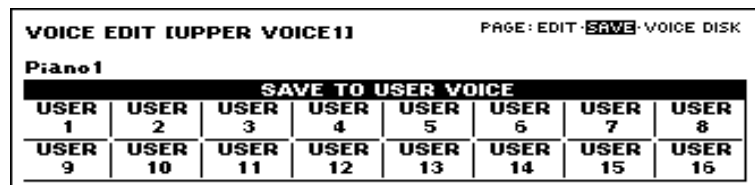

2

Press the Data Control button that corresponds to the User voice number you wish to save to.

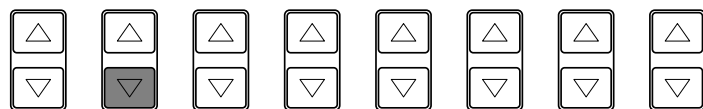
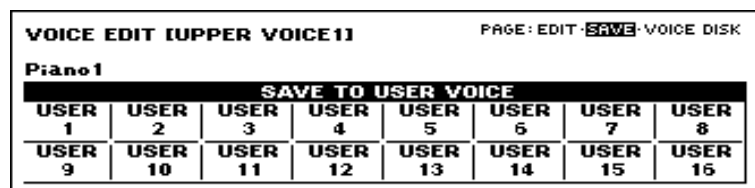

The following display appears, prompting confirmation of the operation. (Saving a new voice automatically erases the voice previously stored to the selected User number.)



NOTE:

The on/off status cannot be saved. If you want an Operator muted, set the OL parameter of the selected Operator to the minimum.

- 3** (If necessary) Press the Data Control buttons below [Edit Name] to give a name to the voice you have edited. The method to edit the name is the same as the one for the song name in the M.D.R. section, See page 89 for more information. Up to 16 characters can be used in this case.

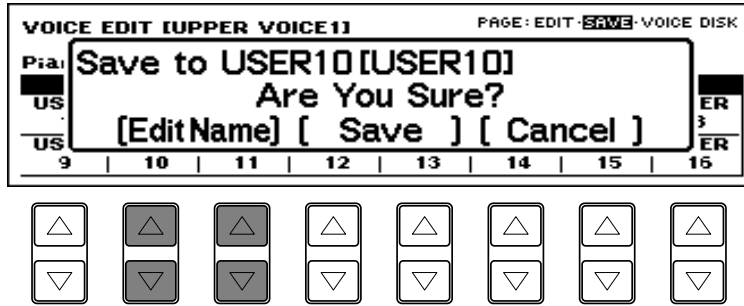

This operation automatically erases any voice that had been previously saved to the selected User voice number. You should check the User voices (page 30) before saving a voice to make sure that you will not be erasing any important voices.

- 4** Press any of the Data Control buttons below [Save] to save the voice, or press any of the buttons below [Cancel] to abort the operation.

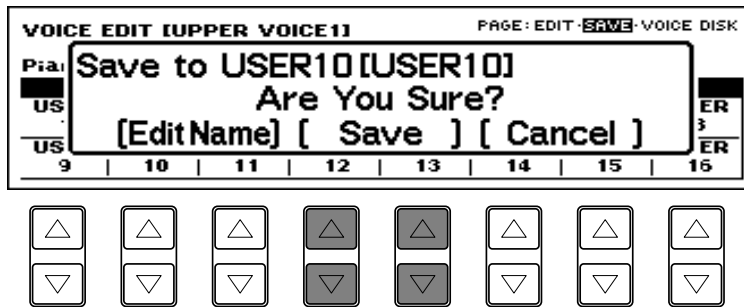

When the voice has been saved, the message "Completed!!" temporarily appears.

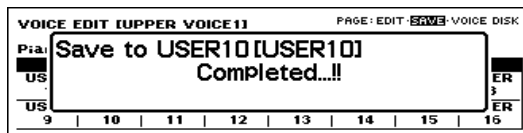

This Save page shows the same voices as the last page (USER) of the dotted buttons' Voice Menu.

3 Quitting Voice Edit

You can quit the Voice Edit function from any of its display pages.

To quit:

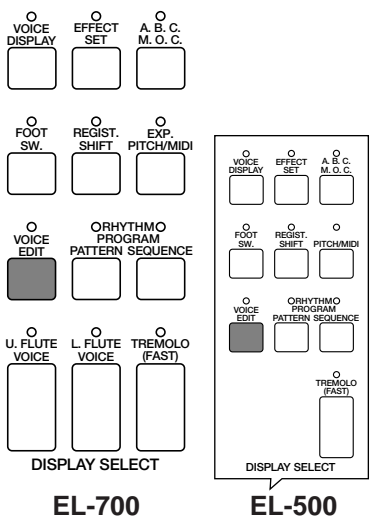

1 Press the VOICE EDIT button in the DISPLAY SELECT section once again.

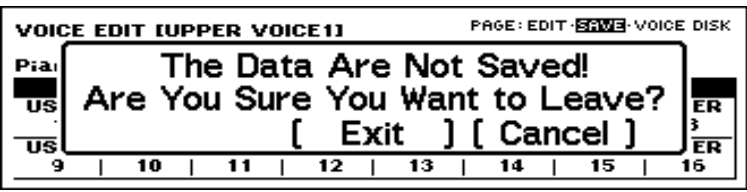

2 Select [Exit] to quit the Voice Edit function, or [Cancel] to abort the operation and return to the previous display.

4 Recalling an Edited Voice

Once the voice has been saved, it can be selected from the last page (USER) of the dotted buttons' Voice Menu (page 30).

To recall a User voice:

1 Press one of the dotted buttons in the voice section you want to use.

2 Use Page buttons to select the USER page.

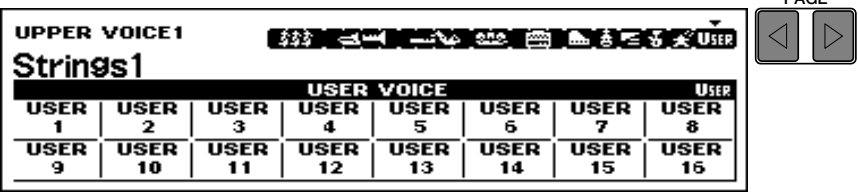

3 Press the Data Control button corresponding to the saved voice.

5 Selecting Voices from a Voice Disk (Optional)

You can also load voices from optional Voice Disks to the 16 User voices in the Voice Menu.

To do this:

- 1 Hold down the VOICE EDIT button in the DISPLAY SELECT section and simultaneously press any one of the panel voice buttons.
- 2 Select the VOICE DISK page with the Page buttons. The message “Insert Voice Disk!!” appears and prompts you the operation.



NOTE:

The EL-700/500 can read the data from the EL-900/90/87 Voice Disk.



NOTE:

Any one of the voice sections can be used here. Make sure that the volumes of all other voices are set off (the minimum value).

- 2 Insert the Voice Disk into the disk slot under the Music Disk Recorder. The voice number and name of the Voice Disk appears.

VOICE DISK Page

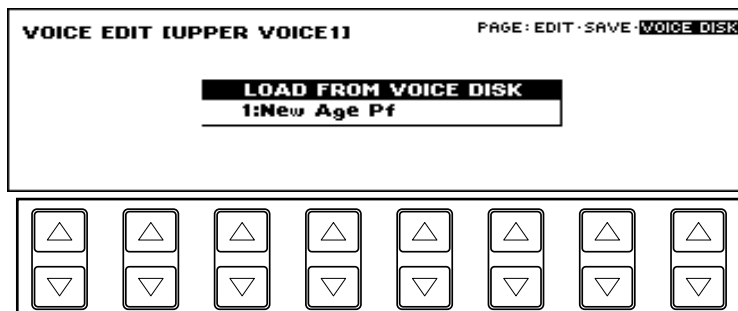

Pressing these buttons steps through the voice numbers; the name of each voice appears on the display as well. Refer to the list included with your Voice Disk for voice numbers and names.

- 4 Using any of the Data Control button pairs, select the voice you wish to load.
- 5 Play the keyboard to check the sound of the voice. Select other voices (as you did in step #4 above) and check those sounds as well.
- 6 If you want to save the current voice to a User Voice space, select the previous page, “SAVE” with the Page buttons.

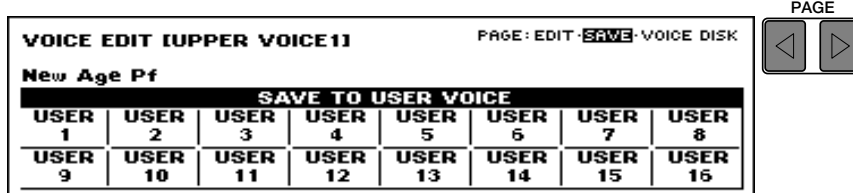

- 7 Press the Data Control button that corresponds to the User Voice number you wish to save to. Press one of the four Data Control buttons below [Save] in the display to save the voice, or one of the four buttons below [Cancel] to abort the operation and return to the previous display. When the voice has been saved, a “completed!!” message appears.

6 Voice Editing Basics

The EL-700/500 Electone uses a versatile tone generation system developed by Yamaha that is capable of producing an exceptionally wide range of voices. To be more specific, the system uses individual sound sources that “modulate” each other’s frequencies and thus create complex sounds not possible by the ordinary mixing of those sound sources.

1) Operators

There are two types of Operators: the one is the sophisticated AWM Operators that are the backbone of the Electone’s authentic voices, the other is called FM Operators. An FM Operator is a sound generator that produces one very simple type of sound: a pure sine wave. A sine wave by itself is not very interesting to listen to; however, when one sine wave is used to modulate a second sine wave, together they result in a new, complex waveform.

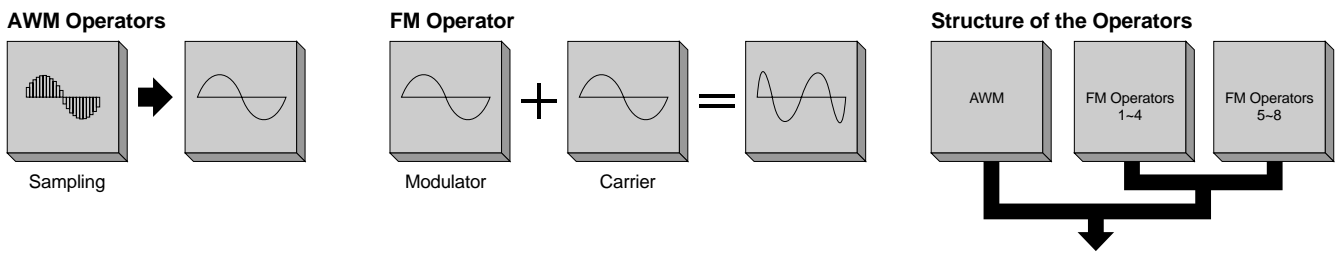

2) Modulators, Carriers and Algorithms

The top Operator, which sends the modulation signal is, not surprisingly, called the modulator. The bottom Operator, which receives or “carries” the modulated sine wave and outputs the resulting sound, is called the carrier. The complexity or brightness of the sound depends on the output level of the modulator.

This kind of arrangement in which Operators are “stacked” together is called an algorithm. With eight sine wave Operators available for stacking, the various algorithms can produce a wide variety of sounds.

Voice Algorithm Examples

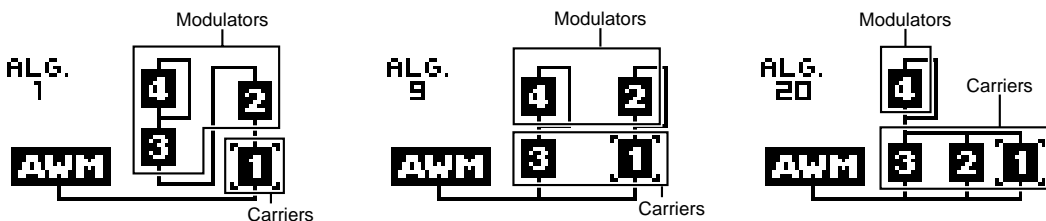

3) AWM Operators

Each algorithm has a special AWM (Advanced Wave Memory) Operator. AWM Operators are not sine waves like the other Operators, but are digital recordings of actual instrument sounds, such as piano, violin, guitar, and so on. The AWM Operator's sound is mixed with the sounds of the other Operators in the algorithm to create realistic voices.

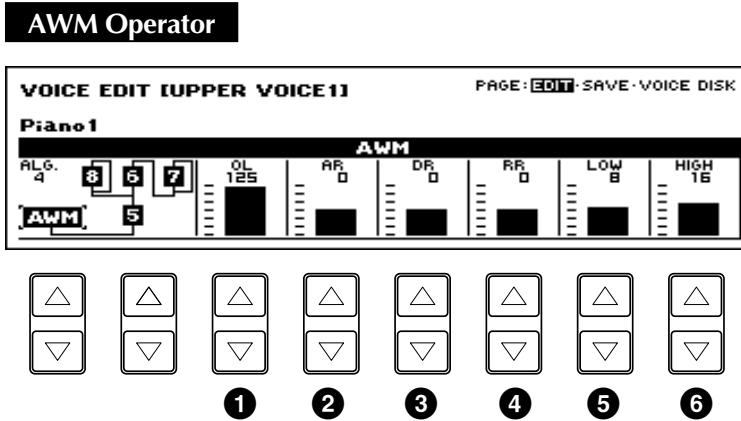

1 OL (Output Level)

Determines the level of the AWM sound.

Range: 0-127

2 AR (Attack Rate)

Determines how quickly the Operator will reach its maximum level after the key is played. Lower values produce a slower attack.

Range: -64 - +63

3 DR (Decay Rate)

Determines how much time it takes for the Operator to reach its second level.

Range: -64 - +63

4 RR (Release Rate)

Determines how much time it takes for the level to reach 0 after the key is released.

Range: -64 - +63

5 LOW

Determines to boost or decrease the output of the lower range of the keyboard.

Range: -64 - +63

6 HIGH

Determines to boost or decrease the output of the higher range of the keyboard.

Range: -64 - +63



NOTE:

Some voices may not have remarkable effect using these AWM parameters.

4) FM Operators

The Operators 1 through 8 are the sine wave Operators of the algorithm. When one of these Operators has been selected, the following parameters are displayed:

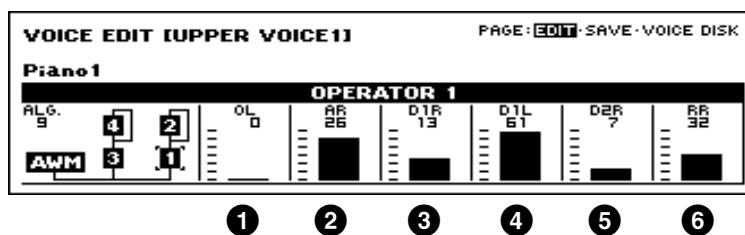

1 OL (Output Level)

Determines the level of the selected Operator's sound.

Range: 0 - 127

2 AR (Attack Rate)

Determines how quickly the Operator will reach its maximum level after the key is played. Lower values produce a slower attack.

Range: 0 - 31

3 DIR (Decay 1 Rate)

Determines how much time it takes for the Operator to reach its second level, set in the Decay 1 Level parameter.

Range: 0 - 31

4 D1L (Decay 1 Level)

Determines the second level setting of the Operator.

Range: 0 - 63

5 D2R (Decay 2 Rate)

Determines how much time it takes for the Operator to reach its third level, or the minimum level before the key is released.

Range: 0 - 31

6 RR (Release Rate)

Determines how much time it takes for the level to reach 0 after the key is released.

Range: 0 - 63



NOTE:

When the D2R is set to 0, the level set by the D1L will be maintained until the key is released.

The higher setting of the D2R rapidly lower the level.



NOTE:

With the RR set too low, the sound continues to sound.

Envelope Parameters

By using the modulators and setting them to various output levels, you can create all kinds of sounds. These sounds will be static, however, unless you have the output levels change in time. That is precisely what an envelope does. It varies the output of an Operator in time so that you can vary the tone or the level. If the output of the modulator changes, the tone will change. If the output level of the carrier changes, the volume will change.

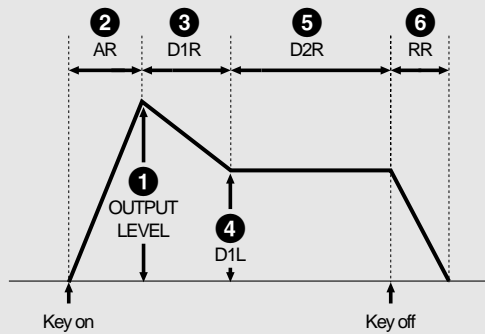

Feedback

The output of a modulator can also be circled back to its input, allowing it to modulate itself as well as the Operator below it. This is called feedback, and it adds harmonic complexity to the tone. Operators using feedback are indicated by a line that encircles the right side of the Operator. Feedback cannot be directly controlled; however, you can adjust the parameters of Operators that have feedback to change the characteristics of the feedback sound.

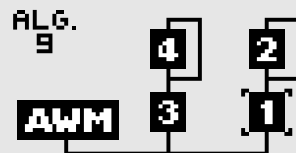

5) General Guidelines for Editing Operators

Before you edit a voice, always check its algorithm to see which Operators function as carriers and which as modulators. Then select each Operator in turn and edit its parameters. The Output Level and envelope parameters function differently depending on whether they belong to a carrier or a modulator. The following list illustrates the relationships between the Operators and parameters:

1	To change the overall volume:	Change 1 of the carrier. Change 7 of the AWM.
2	To change the overall tone:	Change 1 of the modulator. Change 11 or 12 of the AWM.
3	To change how the volume varies over time:	Change 2 , 3 or 5 of the carrier. Change 8 or 9 of the AWM.
4	To change how the tone varies over time:	Change 2 , 3 or 5 of the modulator.
5	To raise the volume:	Raise 1 of the carrier. Raise 7 of the AWM.
6	To lower the volume:	Lower 1 of the carrier. Lower 7 of the AWM.
7	To make the sound brighter:	Raise 1 of the modulator. Raise 12 of the AWM.
8	To make the sound softer:	Lower 1 of the modulator. Lower 12 of the AWM.
9	To get faster attack:	Raise 2 of the carrier and modulator. Raise 8 of the AWM.
10	To get slower attack:	Lower 2 of the carrier and modulator. Lower 8 of the AWM.
11	To reduce the sound rapidly:	Raise 3 and 5 of the carrier and modulator. Raise 9 of the AWM.
12	To reduce the sound slowly:	Lower 3 and 5 of the carrier and modulator. Lower 9 of the AWM.
13	To get no or shorter sustain:	Raise 6 of the carrier and modulator. Raise 10 of the AWM.
14	To get longer sustain:	Lower 6 of the carrier and modulator. Lower 10 of the AWM.
15	To change the timbre rapidly:	Raise 2 of the modulator.
16	To change the timbre slowly:	Lower 2 of the modulator.

FM Carrier/Modulator

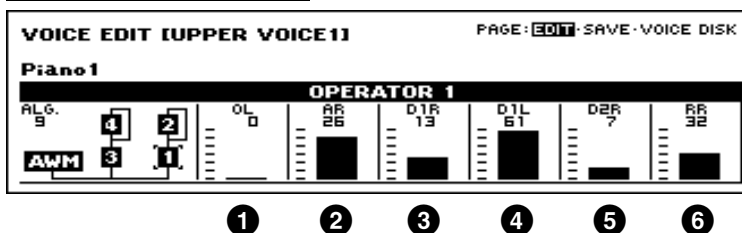

AWM

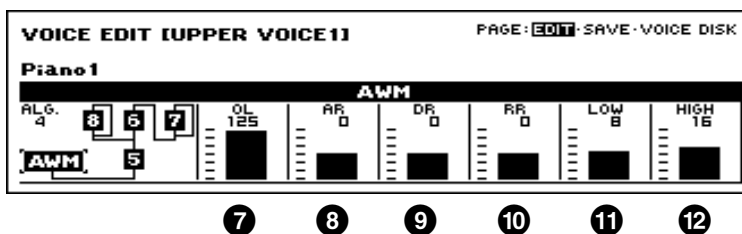

6) Some Voice Editing Examples

The following examples illustrate some specific uses of the Voice Edit controls. Make the changes as described in the examples, then go on to explore some other voices on your own, making changes as you like.

■ Ex. 1: Emphasizing the attack of the “Banjo” voice

This voice is composed mainly of the AWM sampled sound, with the other Operators providing the noise attack sound, simulating the picking of the string.

Try changing the sound of the attack by increasing the Output Level (OL) of Operator 1.

■ Ex. 2: Adding “bite” to the “Jazz Organ1” voice (ORGAN Voice Menu)

Operator 1 provides the 16' footage sound, Operator 2 the 8', and Operator 3 the 5-1/3'.

You can make the sound warmer by decreasing the Output Level of Operator 2. Increasing the Output Level of Operator 3 makes for a rougher edge or more “bite” in the organ sound.

■ Ex. 3: Adding the 5th pitch to the Synth. Lead 5 to create suspended 4th.

Operator 1 is set with the 4th pitch while Operator 5 with the 5th pitch and currently muted. Set the Output Level of Operator 5 from 0 to 90.

■ Ex. 4: Changing the “Trumpet5” voice to a funny trumpet

Not all the Operators are used to create a voice. Replace the active Operators with the inactive Operator.

You can get a funny trumpet by decreasing the OL of the Operators 1 and 3 to 0 and increasing the OL of the AWM to the maximum.

■ Ex. 5: Creating an electronic piano sounds suitable to use as the backings for the ballad from “E.Piano1.”

Increasing the OL of the AWM from 0 to 124 to layer the AWM sounds to the FM sounds.

Rhythm Pattern Program and Rhythm Sequence Program

The Electone also includes powerful Rhythm Program functions: the Rhythm Pattern Program and the Rhythm Sequence Program. The Rhythm Pattern Program allows you to record your own original rhythms using the 120 different high-quality percussion sounds of the Electone. The Rhythm Sequence Program lets you connect your original rhythms together with the Preset rhythms to create complete rhythm tracks, which you can automatically play back during your performance.

Outline of the Rhythm Programming Operation

The following is a brief outline of the steps necessary in programming your own rhythms and rhythm sequences.

Rhythm Pattern Program

Press the PATTERN button to call up the Rhythm Pattern Program and select the BEAT/QUANTIZE page.

Make Beat, Quantize, and Metronome settings.

Select the EDIT page to record percussion sounds and program the pattern. Up to 16 tracks can be used to enter each percussion instrument sound.

(Optional) Select the Accompaniment page to determine which accompaniment pattern will be used with your newly created rhythm, or to create your own backings for the rhythm using the Lower Rhythmic function.

Save your new rhythm to memory in the SAVE page.

Rhythm Sequence Program

Press the SEQUENCE button to call up the Rhythm Sequence Program for connecting rhythms together in sequence to create songs.

Save your new rhythm sequence buttons. (No actual saving procedure is necessary since the rhythm sequences you program will automatically be saved to the selected Sequence button.)

(Optional) Finally, save all the User rhythm data you've created in the above steps to disk.

1 Rhythm Pattern Program

The Rhythm Pattern Program lets you use any of 120 different instruments (percussion sounds) assigned to each key on the Upper and Lower keyboards in creating your own rhythms. Up to 16 separate rhythm “tracks” are provided in a single pattern for each instrument part, and up to 40 patterns—eight User numbers, each with five variations—can be memorized.

1) Entering Rhythm Pattern Program

To call up the Rhythm Pattern Program function :

1 Press and hold down the PATTERN button in the DISPLAY SELECT section. The LED of the button lights and the display prompts you to select a rhythm.

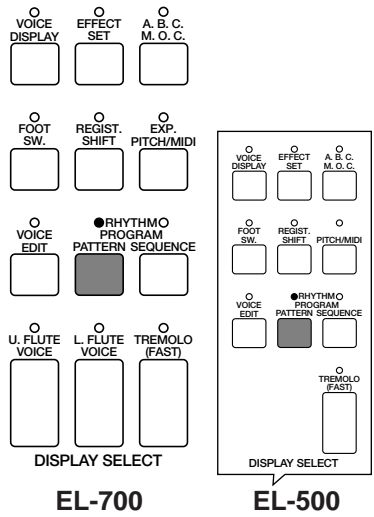

 NOTE:

Pressing the PATTERN button here also automatically stops the rhythms and rhythm sequences.

 NOTE:

Use of the playback and recording functions on the Music Disk Recorder automatically cancels the Rhythm Programming/Rhythm Sequencing operations.



There are two ways to program a User pattern: copying a preset rhythm which is similar to the rhythm you want to create and creating your own rhythm from scratch.



NOTE:

The User rhythm you have created can also be copied to the Rhythm Pattern Program. You can edit it again and improve it.



NOTE:

When preset rhythms are copied to the Rhythm Pattern Program, the copied patterns may differ in volume from the original patterns.



NOTE:

Some Ending patterns consists of more than two measures. If you copy such a pattern, only the first two measures can be copied but the rest cannot be copied.



NOTE:

The Intro. patterns cannot be copied.

2

2.-1 To copy a preset rhythm:

While holding down the PATTERN button, select a preset rhythm to be copied to the Rhythm Pattern Program.

Copying a preset rhythm lets you make changes to an existing rhythm, saving you time if you want to program a rhythm that is similar to an existing preset pattern. Two measures of the selected rhythm will be copied to the Rhythm Pattern Program.

In this case, you need to select a specific rhythm from the Rhythm Menu beforehand.

Copying the Fill Ins and Endings:

The similar procedure can be used with the FILL IN and INTRO. ENDING buttons for copying Fill In and Ending patterns. Select the rhythm to which the desired Fill In or Ending belongs beforehand. Then press the FILL IN or INTRO. ENDING button while holding down the PATTERN button.

2.-2 To create your own rhythm from scratch

Pressing the PATTERN button, and releasing it without selecting a rhythm loads a blank pattern to the Rhythm Pattern Program.

2) Percussion Sounds Used for Rhythm Pattern Program

The total of 120 different instruments are available for the Rhythm Pattern Programming and are divided into two instrument sets: Normal and Extend, and assigned to each key on the Upper and Lower keyboards, as shown in the following chart.

Normal Set

Consists of 91 different drum and percussion instruments.

Assigned to the Upper Keyboard (47)

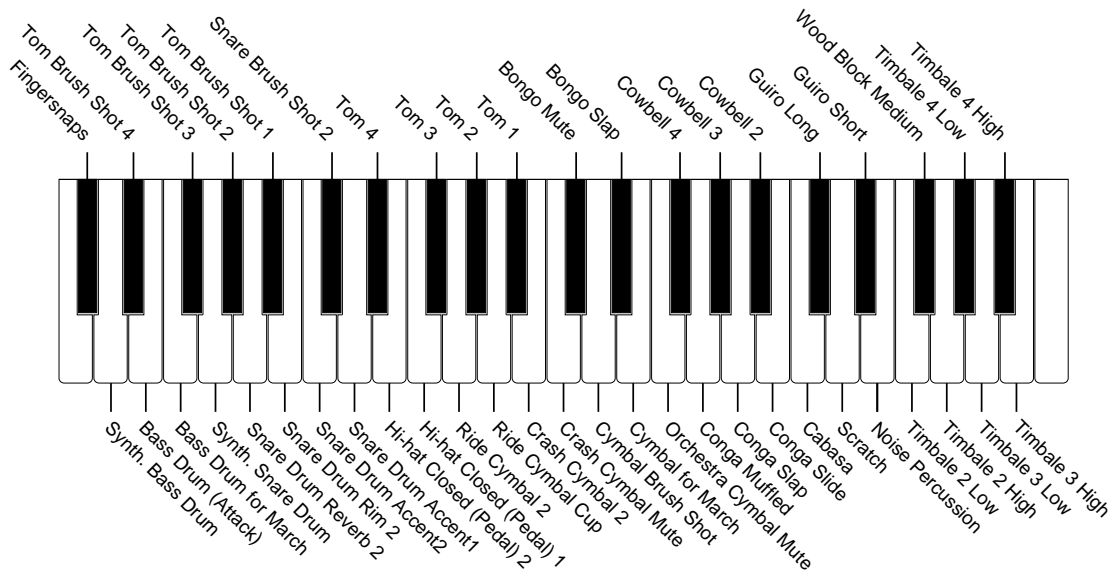

Assigned to the Lower Keyboard (47)

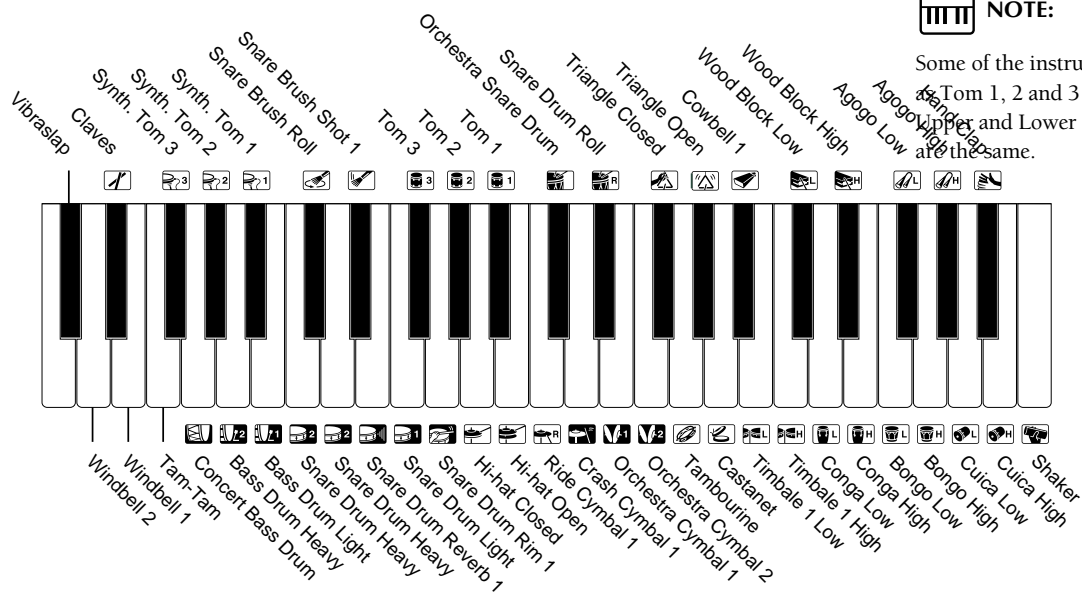

NOTE:

Some of the instruments such as Tom 1, 2 and 3 on the upper and lower keyboards are the same.

Extend(ed) Set

Consists of 29 different drum and percussion instruments.

Assigned to the Upper Keyboard (13)

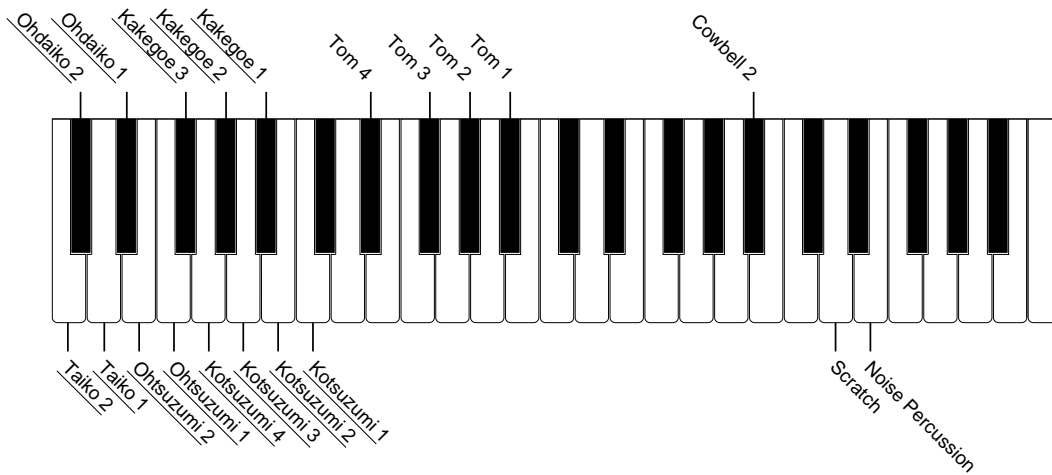

Assigned to the Lower Keyboard (16)

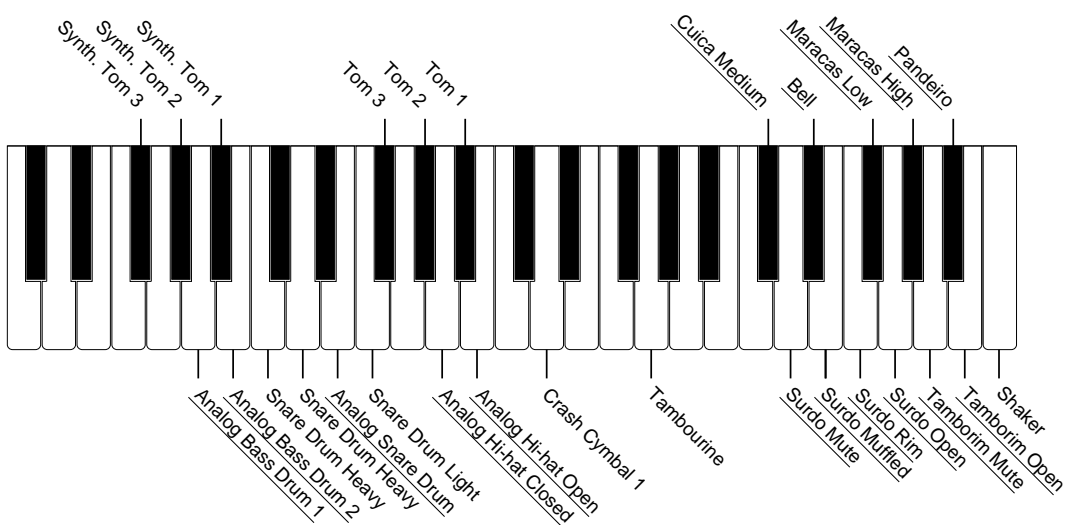

NOTE:

Some of the instruments such as Tom 1, 2 and 3 on the Upper and Lower keyboards are the same. The instruments marked with the underlines are exclusive to the Extend(ed) Set.

3) Step Write and Real Time Write

There are two different methods you can use to program rhythms: Step Write and Real Time Write.

Step Write allows you to enter percussion sounds as individual note values. As a method, it is very similar to writing down the notes on a sheet of music paper; each note is entered one at a time, and though you can hear each individual note entered, you cannot actually hear the pattern playing as you create it.

Real Time Write on the other hand, is similar to using a multitrack tape recorder; you can hear previously recorded parts of the pattern as you record new parts on top.

Each method has its own advantages and uses. Step Write is good for precision and for entering percussion sounds whose note placement and rhythmic value has been determined, such as a bass drum that plays every beat in a measure. Real Time Write is best for capturing the “feel” of a rhythm, because it allows you to actually play the pattern as you are creating it. Which method you use depends partly on the type of rhythm you intend to create and partly on your own personal preference. You can even switch between the two methods in editing to create a single rhythm by the use of both methods. This would come in handy, for example, in programming the basic beats of a rhythm with Step Write, then using Real Time Write to add percussion accents and embellishments.

4) Selecting Step Write or Real Time Write Operation

Step Write and Real Time Write can be selected from either the BEAT/QUANTIZE page or the EDIT page. Which mode of operation is selected depends on the play status of the rhythm. If the rhythm is stopped, Step Write is automatically selected. If the rhythm is playing, Real Time Write is selected. Simply press the START button in the Rhythm section on the panel to start or stop the rhythm and switch between the two modes.

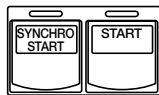

5) Setting the Beat/Quantize Values

The BEAT/QUANTIZE page is automatically displayed when calling up the Rhythm Pattern Program. It is used in both Step Write and Real Time Write for selecting the basic timing settings of the pattern.

BEAT/QUANTIZE Page—Step Write

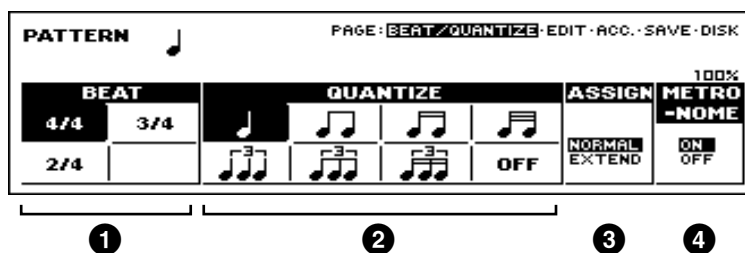

NOTE:

Beat can only be changed when the rhythm is stopped.

1 BEAT

Determines the time signature used for the rhythm. Available time signatures are 2/4, 3/4 and 4/4. The 4/4 time is the default setting when a blank pattern has been selected.

2 QUANTIZE

Determines the resolution of the Step Write function. Step Write operations involve advancing in “steps” along regularly spaced points in a measure and Quantize lets you set how many points there will be in the measure. The default setting is a quarter note.

In Real Time Write, this function is generally the same as that in Step Write operation. Used with Real Time Write, however, it allows you to automatically “correct” the timing of the notes you enter, according to the specified Quantize resolution.

3 ASSIGN (NORMAL/EXTEND)

Selects the instrument set you want to use. Two types are available:

NORMAL: 91 different instruments are assigned to the Upper and Lower keyboards.

EXTEND: 29 different instruments are assigned to the Upper and Lower keyboards.

4 METRONOME—Real Time Write only

Turns the metronome click on or off. When set to ON, the metronome sounds on each beat of the measure (for example, three times per measure in 3/4 time) to serve as a rhythmic guide when programming patterns. The metronome can be turned on or off while a rhythm is playing.



NOTE:

Refer to page 125 for the instrument assignments of each set.



NOTE:

The metronome is automatically set to ON when a blank pattern has been selected, and is set to OFF when an existing pattern is copied.

BEAT/QUANTIZE Page—Real Time Write



NOTE:

The positions at which the sounds are input will be corrected according to the predetermined quantize value in Real Time Write operation.

6) Entering Percussion Sounds to a Rhythm Pattern

Percussion sounds can be entered by either Step Write or Real Time Write from the EDIT page. (Sounds can also be entered in the BEAT/QUANTIZE page by Real Time Write.) As with the BEAT/QUANTIZE page above, the Step Write EDIT page is selected when the rhythm is stopped, and Real Time Write EDIT is selected when the pattern is running.

7) Editing with Step Write

To enter sounds with Step Write:

- 1 Raise the rhythm volume, and turn off all the Upper and Lower keyboard voices by setting each section's volume to MIN.
- 2 Select the EDIT page with the Page buttons.
- 3 Select the percussion sound you wish to enter.

There are two ways to select percussion sounds in the Step Write mode:

[1] Press the key on the Upper or Lower keyboard that corresponds to the sound. The instrument name automatically appears at the top right of the LCD when the key is pressed. The selected instrument is automatically assigned to an available empty rhythm track.

[2] Use the leftmost Data Control buttons under the rhythm track number to step through the available sixteen rhythm tracks. The name of the instrument currently assigned to the selected track is displayed at the top right of the LCD. (Since this method allows you to select only from among the assigned instruments, use the Change function described with the LCD below to change instrument assignments.)
* This method is especially useful when editing an existing rhythm, preset or user.

EDIT Page—Step Write

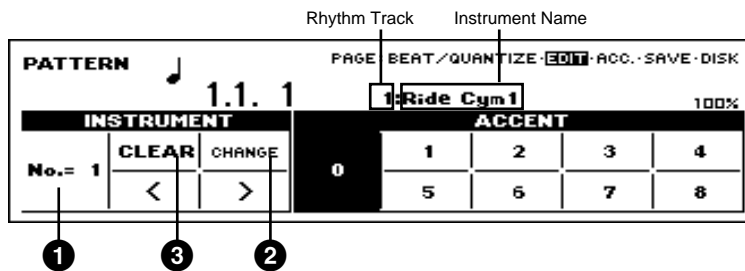

- 1 **Rhythm Track**
Selects from among the sixteen rhythm tracks and displays the currently selected rhythm track number.
- 2 **CHANGE**
Replaces the instrument assigned to any given track with the others.

To replace the instrument:

1. Select the track using the Rhythm Track control above.
2. Simultaneously hold down the Data Control button corresponding to CHANGE and press the key on the Upper or Lower keyboard that corresponds to the instrument you want to use.

3 CLEAR

The Clear function is used to erase an instrument from the rhythm. All instances of the selected instrument, irrespective of which tracks they occupy, will be erased from the pattern.

There are two ways to use Clear:

[1] While holding down the Data Control button corresponding to CLEAR, press the key on the keyboard corresponding to the instrument you wish to erase. (A short “beep” sound indicates that the instrument has been erased.)

You can erase all of the sounds on all recorded tracks of the pattern by holding down the Data Control button corresponding to CLEAR and simultaneously pressing the lowest key (C1) on the Lower keyboard.

Be careful not to do this inadvertently since all sounds will be instantly and permanently erased.

[2] Press, then release the Data Control button corresponding to CLEAR. The following display appears, prompting confirmation of the operation:

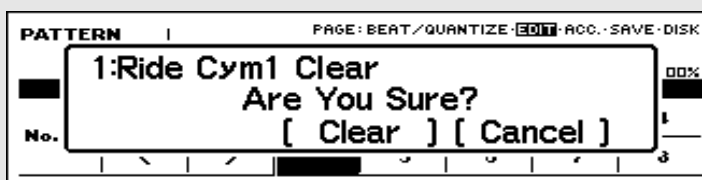

Select [Clear] to execute the operation. The message "Completed!!!" briefly appears.

Select [Cancel] to abort the operation returning to the previous display.

- 4 Then, use the step forward and step reverse controls to advance or reverse the rhythm clock to the point at which you wish to enter the percussion sound.

EDIT Page—Step Write

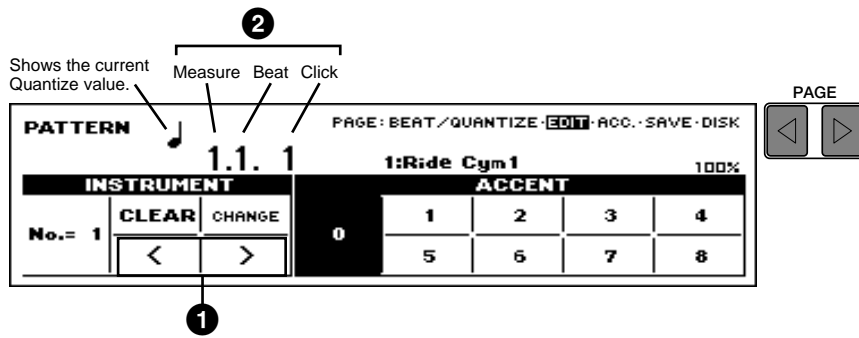

1 Step Forward and Step Reverse Controls

Each press of the corresponding Data Control buttons advances or reverses the rhythm clock by one step. The size of a single step is determined by the Quantize value, set in the Beat/Quantize page.

2 Rhythm Clock

Displays the current position in the pattern, according to the measure, beat, and number of clicks. A click is the smallest division of a pattern, and one beat is made up of 24 clicks.

The rhythm clock advances up to two measure and loops back to the beginning of the rhythm (1.1.1).



NOTE:

If you have copied an existing pattern, its name will be shown below PATTERN on the display.



NOTE:

You can return to the BEAT/QUANTIZE page in the middle of editing and change the time signature and/or the Quantize value.

5

Use the Accent section of the EDIT page to enter the sound to the selected point.

Press the Data Control buttons corresponding to each Accent to actually enter the percussion sounds. The Accent section has nine steps, from a minimum of 0, or no sound, to a maximum of 8. The Accent 0 can be used when entering rests.

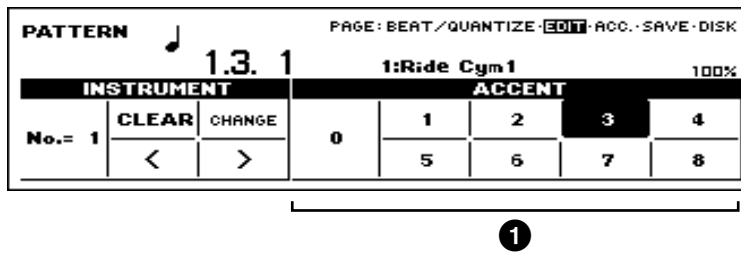

1 ACCENT

Records the instrument and determines its volume or Accent level. Press the Data Control button that corresponds to the Accent level you wish to set; the instrument is automatically inserted at that Accent level to the selected position in the pattern (shown in the rhythm clock).

Selection of an Accent level automatically advances the rhythm clock by one step, according to the current Quantize resolution value.

6

Repeat the above procedures #2 through #5 to layer each rhythm track and complete your own rhythm.



NOTE:

You can record up to sixteen different instrument sounds in a single rhythm, with each instrument occupying one of the sixteen available tracks.

Instruments can only be entered if there are empty tracks remaining. If all sixteen tracks have been used, no subsequently selected instruments can be recorded.

The Rhythm Pattern Program has polyphonic capacity for playing up to 32 sounds simultaneously.

About Quantize

The Quantize function is a process of rounding off timing and/or duration values.

With Real Time Write

It allows you to automatically correct the timing of the notes you play, according to the specified Quantize resolution. The range can be corrected is within 50 percent of the selected note (Quantize) value. No correction occurs when you select OFF.







With Step Write

It allows you to automatically correct the length (duration) and timing of each note you enter.

Quantize Values

	Quarter note (1 beat)		Eighth note (1/2 beat)
	16th note (1/4 beat)		32nd note (1/8 note)
	Quarter note triplet (2/3 beat)		Eighth note triplet (1/3 beat)
	16th note triplet (1/6 beat)	OFF	OFF (1/24 beat)

Steps Depending on the Quantize Values

	1 beat																							
	1																							
	1												13											
	1			7				13						19										
	1	4	7	10	13	16	19	22																
	1																17							
	1								9								17							
	1				5				9				13				17				21			
OFF	1	2	3	4	5	6	7	8	9	10	11	12	13	14	15	16	17	18	19	20	21	22	23	24

* The finest timing is a Click (=1/24 beat).

*  advances 16 clicks every step.

8) Editing with Real Time Write

To enter sounds with Real Time Write:

- 1 Raise the rhythm volume, and turn off all the Upper and Lower keyboard voices by setting each section's volume to MIN.
- 2 Select the BEAT/QUANTIZE page or EDIT page with the Page buttons, then start the rhythm by pressing the START button to engage the Real Time Write operation.

EDIT Page—Real Time Write



Only “CLEAR” is selectable on the EDIT Page in Real Time Write.

● CLEAR

As in Step Write, the Clear function is used to erase an instrument from the rhythm. However, the method of operation is slightly different.

Hold down the Data Control button that corresponds to CLEAR in the display, and simultaneously press the key on the keyboard corresponding to the instrument you wish to erase. All instances of the selected instrument, irrespective of which tracks they occupy, will be erased from the pattern.

You can erase all of the sounds on all recorded tracks of the pattern by holding CLEAR and pressing the lowest key (C1) on the Lower keyboard. Be careful not to do this inadvertently since all sounds will be instantly and permanently erased.

- 3 While the rhythm is running, play the percussion sounds from the Upper and/or Lower keyboards.
Each instrument sound is recorded and automatically assigned to a separate track as you play it. All events of a single sound are assigned to the same track; for example, if you alternately play a hi-hat sound with a snare drum, all notes of the hi hat will be recorded to one track and all notes of the snare drum to another track.
- 4 When you've finished entering instruments to the pattern, stop it by pressing the START button again, or by selecting the ACC. (Accompaniment) or SAVE pages.



NOTE:

As in Step Write, you can record up to sixteen different instrument sounds in a single rhythm, with each instrument occupying one of the sixteen available tracks. Instruments can only be entered if there are empty tracks remaining. If all sixteen tracks have been used, no subsequently recordings can be performed or heard.

9) Selecting Accompaniment Patterns

The Rhythm Pattern Program allows you to use one of the Electone's Accompaniment patterns with your original rhythm. You can select and save the Accompaniment pattern that best matches the rhythm that you have created. Also, the Rhythm Pattern Program lets you use the Lower Rhythmic function to add your own backings, two measure long lower rhythmic patterns, to the rhythm you created.

To select an appropriate Accompaniment pattern for your newly created rhythm:

- 1 Select the ACC. (Accompaniment) page with the Page buttons.

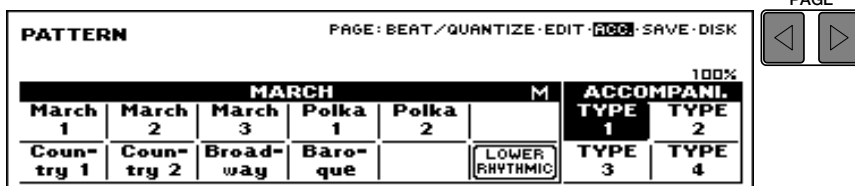

- 2 Press the button corresponding to the desired rhythm type that contains the accompaniment you want to use, in the Rhythm section on the panel.

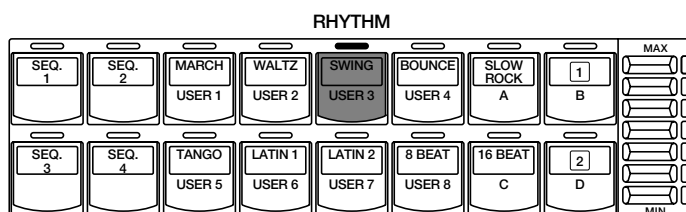

- 3 Select the desired rhythm from the menu with the Data Control buttons.

The accompaniment type selected here can be saved with the user rhythm. However, you cannot save the selection of the Accompaniment TYPE and the changes in the Rhythm Condition page.

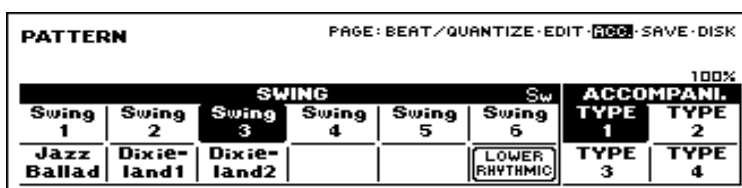

NOTE:

If a rhythm is started in the Accompaniment page, the Accompaniment will also be heard. However, both the rhythm and the Accompaniment will automatically be stopped when you leave the Accompaniment page.

- 4 You can also call up the Rhythm Condition page from the above display and set the Accompaniment volume to audition the rhythm. To do this, press the same Data Control button as you did in step #3 above in selecting a rhythm, and adjust the Accompaniment volume with the appropriate Data Control buttons.

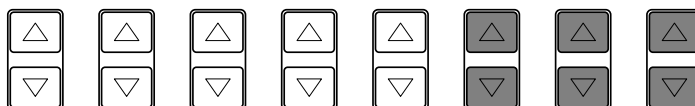
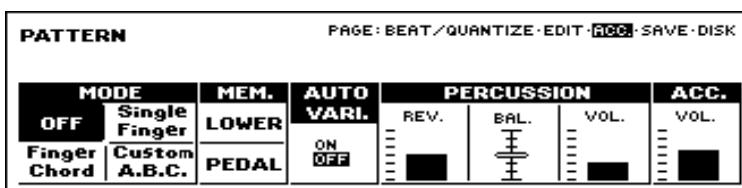

To create your own backings with the Lower Rhythmic function:

You can add backings (lower rhythmic pattern) to the rhythm. The lower rhythmic pattern, using one track, can be entered by the same method as the one for the rhythm.

- 1 Select the ACC. (Accompaniment) page with the Page buttons.



- 2 Select the bass pattern, or the Accompaniment type which contains the bass pattern you want to use.



NOTE:

You cannot create your own bass pattern.

- 3 Press the Data Control buttons corresponding to LOWER RHYTHMIC. The following display appears.

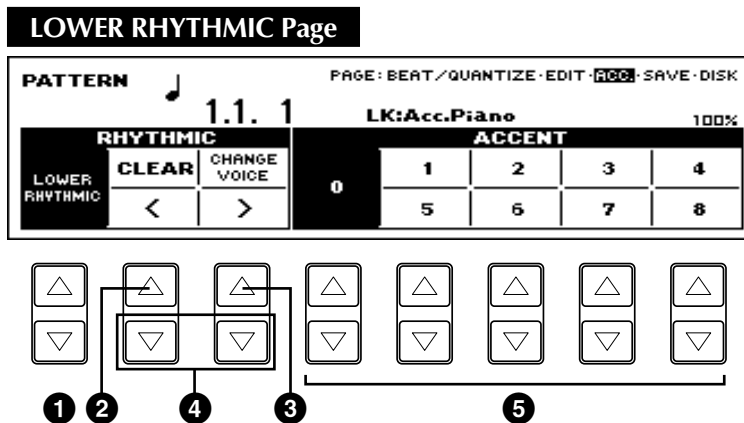

- 1 **LOWER RHYTHMIC**
Indicates that the Lower Rhythmic function is engaged. Pressing the corresponding Data Control buttons returns you to the previous display.
- 2 **CLEAR**
Erases the rhythmic pattern you entered.
- 3 **CHANGE VOICE**
Selects the voice used for the rhythmic pattern from the 16 different voices.

Pressing the Data Control button corresponding to CHANGE VOICE opens the following message on the display. Select the voice you want to use by pressing the Data Control buttons corresponding to ▲▼.

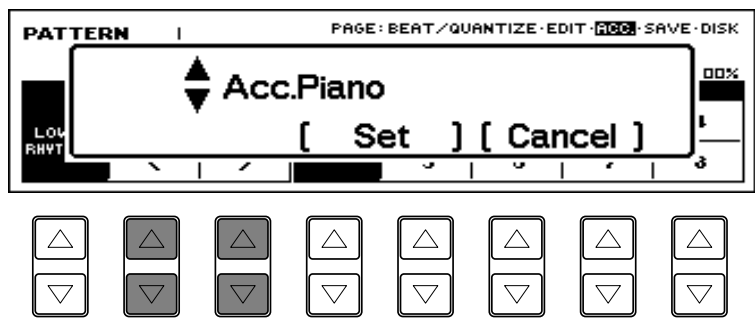

The available voices are as follows:

- Acc.Piano
 - Acc.EP (Electric Piano)
 - Acc.FolkGt (Acoustic Guitar)
 - Acc.JazzGt (Jazz Guitar)
 - Acc.Banjo
 - Acc.ElecGt (Electric Guitar)
 - Acc.MuteGt (Muted Guitar)
 - Acc.DistGt (Distortion Guitar)
 - Acc.Brass
 - Acc.Horn
 - Acc.Sax (Saxophone)
 - Acc.Clari (Clarinet)
 - Acc.JzOrg (Jazz Organ)
 - Acc.Accord (Accordion)
 - Acc.Woody
 - Acc.Metal
- * Acc.: Accompaniment

4 Step Forward and Step Reverse Controls

Each press of the corresponding Data Control buttons advances or reverses the rhythm clock by one step. The size of a single step is determined by the Quantize value, set in the Beat/Quantize page.

5 ACCENT

Records the selected voice and determines its volume or Accent level.



NOTE:

When the user rhythm contains the lower rhythmic pattern data, the ACC. page is always engaged with the Lower Rhythmic function. If you want to use a preset accompaniment for your rhythm, you need to erase the lower rhythmic pattern data using the Clear operation.



NOTE:

You can audition the rhythmic pattern you entered by starting the rhythm. In this case the accompaniment volume ignores the value set on the Rhythm Condition display and will be at the maximum value.

- 4
- 5
- 6
- 7

Select a voice used for the rhythmic pattern.

(If necessary) Choose the BEAT/QUANTIZE page and select the desired quantize value.

Returns to the Lower Rhythmic (ACC.) page and press the appropriate Accent button to actually enter the notes.

Repeat the above #5 and #6 steps to complete your own rhythmic pattern.

10) Saving Rhythm Patterns

To save a newly created rhythm to a User pattern number:

- 1 Select the SAVE page with the Page buttons.
The current rhythm, if playing, will automatically be stopped when this page is selected.

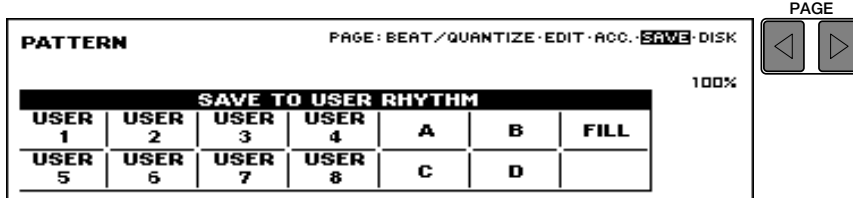

- 2 Using the appropriate Data Control buttons, select both the User number and variation type to which you wish to save the newly created rhythm.
Keep in mind that you cannot save a rhythm by selecting only a User number; you must also select a variation type-A,B,C,D, or FILL (Fill In). Including the Fill In patterns, up to 40 different rhythms (8 User numbers x 5 variations) can be saved.

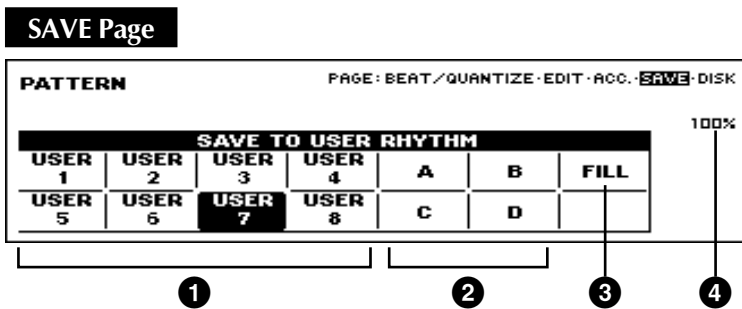

- 1 **USER1 - 8**
USER Numbers
- 2 **A~D**
Variations
- 3 **FILL**
Fill In
- 4 **Remaining Memory**
Indicates the amount of memory available for storing rhythms. This is expressed as a percentage: 100% indicates the maximum amount of memory available, and 0% indicates that there is no more memory available.

Once you have selected a User number and type, the following display will appear, prompting confirmation of the operation.

3 (If necessary) Press the Data Control buttons below [Edit Name] to give a name to the rhythm you have created. The method to edit the name is the same as the one for the song name in the M.D.R. section, See page 89 for more information. Up to 10 characters can be used in this case.

4 Select [Save] to save the rhythm or [Cancel] to abort the operation and return to the previous display.



When the pattern has been saved, the message “Completed!!” momentarily appears.

When the pattern cannot be saved because of lack of available memory space, the following display appears.

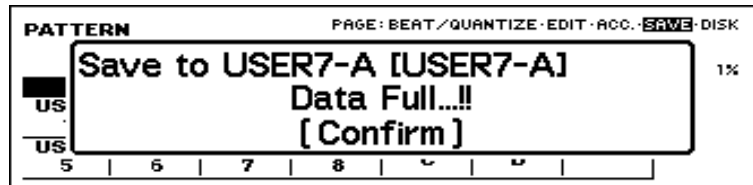

NOTE:

The Power On Reset function (page 83) can be to delete all User rhythms from memory.

You should periodically save your rhythm as you are making it and check the amount of remaining memory. If the rhythm currently being edited cannot be saved because of a lack of memory space, erase some of the less necessary percussion sounds with the Clear function, and try saving the pattern again.

11) Quitting the Rhythm Pattern Program

You can quit the Rhythm Pattern Program from any of its display pages.

To do this:

1 Press the PATTERN button in the DISPLAY SELECT section once again. If a rhythm is playing, it will automatically be stopped. The following display will appear, prompting confirmation of the operation.

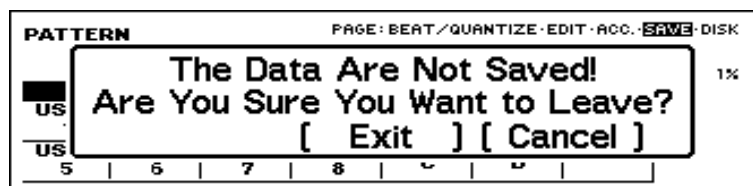

2 Select [Exit] to leave the Rhythm Pattern Program, or [Cancel] to abort the operation and return to the previous display.



NOTE:

If you leave the Rhythm Pattern Program without having edited any patterns, this display will not appear.

12) Recalling User Rhythm Patterns

The User rhythms you have created in the Rhythm Pattern Program can be selected and played from the panel Rhythm controls.

To call up the User rhythms:

- 1 Press one of the Dotted buttons in the Rhythm section.

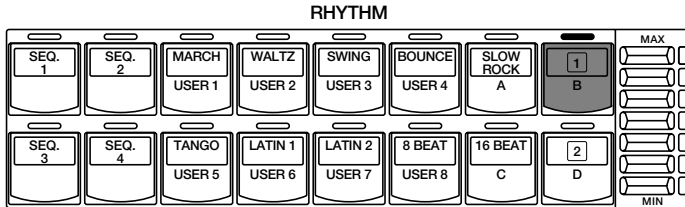

The Rhythm Menu appears.

- 2 Select the USER page with the Page buttons.

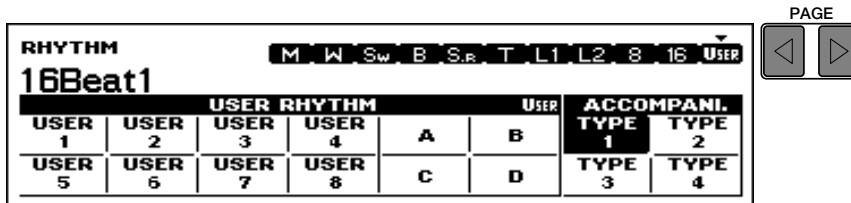

- 3 Select the desired User rhythm from the LCD display by using the Data Control buttons. Be sure to select both a User number and a variation type (A, B, C, or D).

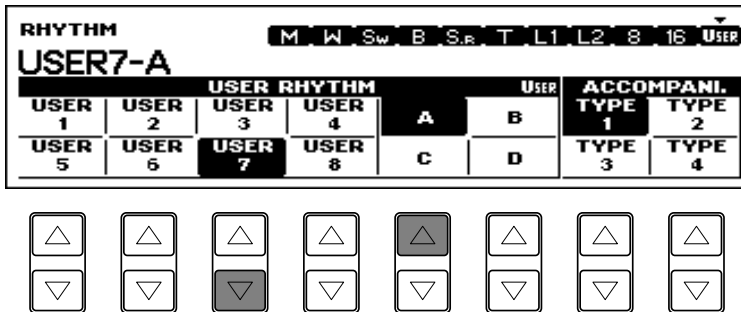

NOTE:

When you select the user rhythm with the Lower Rhythmic function (page 135) turned on, "RHYTHMIC" will be shown above the "ACCOMPANI." on the LCD display.

Playing User Fill In Patterns:

You can play User Fill In patterns by selecting the desired User number and pressing the FILL IN button in the Rhythm section on the panel.



NOTE:

A press of the FILL IN button plays back only the first measure if you have created a two-measure fill in pattern. Holding down the FILL IN button allows you to play back the entire fill in pattern.

13) Selecting Rhythms From a Pattern Disk (Optional)

You can also load the rhythms from optional Pattern Disks to the User rhythms in the Rhythm Menu.

To do this:

- 1 Press the PATTERN button in the DISPLAY SELECT section.
- 2 Select the DISK page with the Page buttons. The message “Insert Pattern Disk!!” appears and prompts you the operation.
- 3 Insert the Pattern Disk into the disk slot under the Music Disk Recorder. The pattern number and name from the Pattern Disk appears.

PATTERN DISK Page

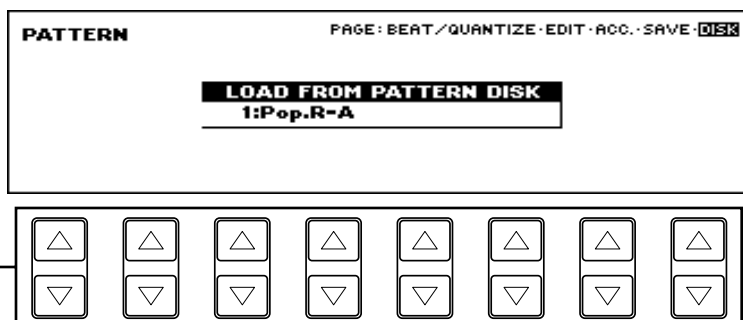

Pressing these buttons steps through the pattern numbers; the name of each pattern appears on the display as well. Refer to the list included with your Pattern Disk for pattern numbers and names.

- 4 Using any of the Data Control button pairs, select the pattern you wish to load.
- 5 Start the rhythm to check the pattern to be called up. Select other patterns (as you did in step #4 above) and check those patterns as well.
- 6 If you want to save the current pattern to a User Rhythm space, select the previous page, “SAVE” with the Page buttons.
- 7 Press the corresponding Data Control buttons to designate both the User Rhythm number and its variation type (A, B, C, or D). Press one of the four Data Control buttons below [Save] on the display to save the pattern, or one of the four buttons below [Cancel] to abort the operation and return to the previous display. When the pattern has been saved, a “completed!!” message appears.

2 Rhythm Sequence Program

With the Rhythm Sequence Program function, you can connect any of the Electone's existing rhythms and the rhythms of your own creation together to make complete rhythm compositions. You can save four rhythm compositions to the Sequence buttons on the panel for future recall.

1) Selecting a Sequence

- Press the SEQUENCE button in the DISPLAY SELECT section. The LEDs of the numbered Sequence buttons in the Rhythm section on the panel will flash and the following display will prompt you to select a sequence number.

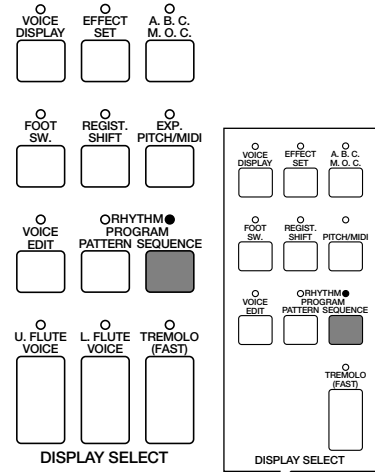
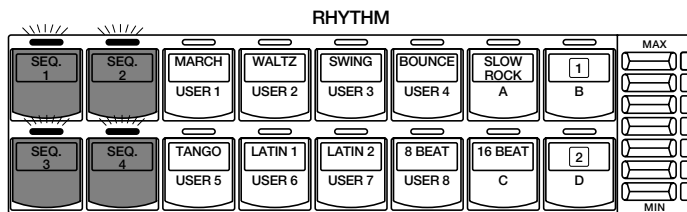
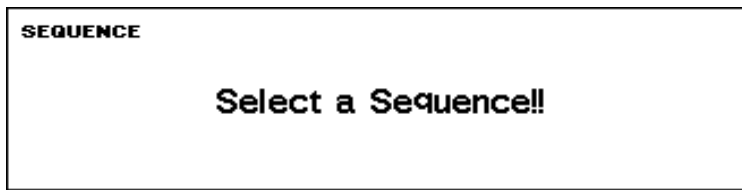

EL-700

EL-500



NOTE:

When you select one of the sequences in this step, any editing done to that sequence is instantly and automatically saved. This means that if you select a sequence that is already programmed, any editing you do will permanently change the sequence and the original sequence cannot be recovered.

- Press one of the Sequence buttons to call up the Rhythm Sequence display.

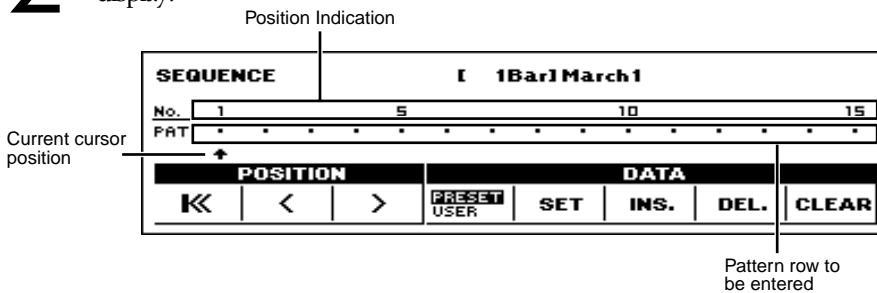

In this display, different rhythms (both Preset rhythms and User rhythms that you created with the Rhythm Pattern Program) can be entered in sequence along the pattern row in the middle of the display. Entered patterns are shown in boxes, while the numbers in the row above indicate the position.

Up to three-character code inside each box indicates the type and number of the rhythm. The preset rhythms of the Electone are indicated by a two-digit number (i.e., [05] or [16]). User patterns are indicated by the "U" prefix as well as a letter suffix representing the type-A,B,C,D, and F (Fill In). Examples of these include [U3C] and [U8F]. The preset patterns also may have a letter suffix: "I" indicates Intro, "F" indicates Fill In, and "E" indicates Ending (i.e., [01I], [20F], and [16E]).



NOTE:

Any rhythm currently playing will automatically be stopped when you call up the Rhythm Sequence Program function. Also, use of the Music Disk Recorder function automatically cancels Rhythm Sequence operations.

2) Programming a Sequence

1 Select the type of rhythm you wish to enter, Preset or User.

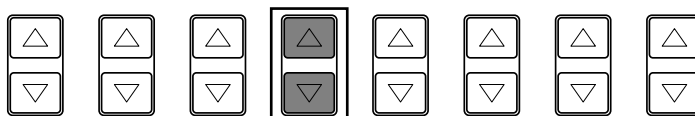
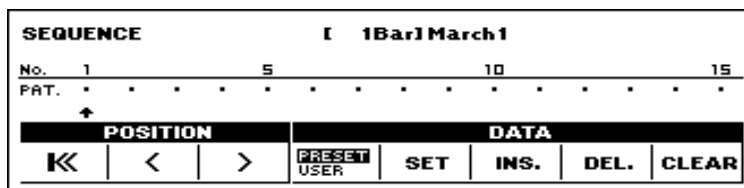

Press these Data Control buttons to select PRESET and USER, alternately.



You can program the rhythm sequence a measure at a time. Every User rhythm consists of two measures. If you want to program two-measure User rhythms, you are required to enter it twice, for the first measure and the second measure. When entered, the first measure is displayed as positive box **U1A** and the second measure is displayed as negative box **U1A**.

The rhythm patterns can be divided into four groups: Normal such as **D1** and **U1A**, Intro, Fill In and Ending. When changing the type, for example, from Normal to Fill In and Fill In to Normal while programming a rhythm sequence, the first measure of the newly selected type will always be selected and follow. However, when the same type continues even though you change the rhythm, for example, from **U5** to **U1A**, the second measure may succeed the sequence.

That means some of the User rhythms inserted in a rhythm sequence may begin from its second measure.

To keep this from happening and begin the newly selected rhythm from the first measure, insert a different type, Fill In, before using the new rhythm pattern.



NOTE:

A maximum of 120 patterns can be entered to a single sequence.

2

Select the desired rhythm by pressing the appropriate button in the Rhythm section, then select SET in the display to enter the pattern. (Refer to the Rhythm Pattern Number Table below for a list of the rhythms and their number assignments.)

- When PRESET is selected in step #1 above, the Rhythm buttons are used to select the Preset rhythm names printed at the top.
- When USER is selected, however, these buttons function according to the User numbers and letters printed at the bottom. Select the User pattern by pressing one of the numbered buttons (1-8), then a lettered button (A, B, C, or D) or FILL (for User Fill In).

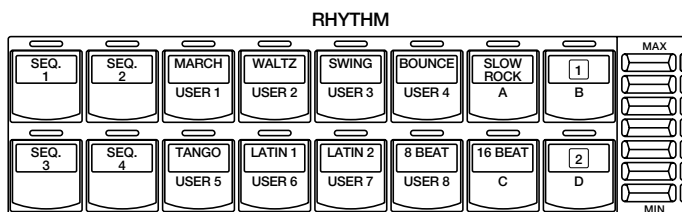

Currently selected pattern, or the pattern at the current cursor position.

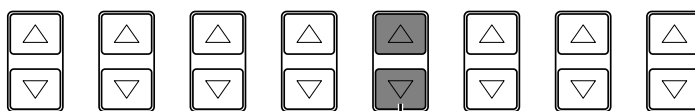
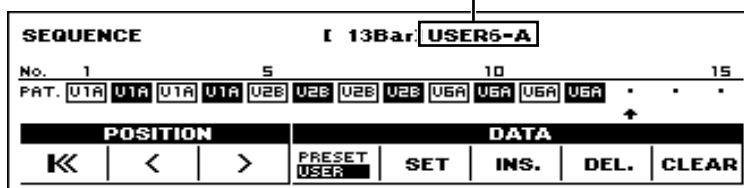

Press SET to select the rhythm pattern.

Rhythm Pattern Number Table

01	March 1	18	Bolero	35	Slow Rock 3	52	8 Beat 3
02	March 2	19	Swing 1	36	Tango 1	53	8 Beat 4
03	March 3	20	Swing 2	37	Tango 2	54	8 Beat 5
04	Polka 1	21	Swing 3	38	Tango 3	55	Dance Pop 1
05	Polka 2	22	Swing 4	39	Cha-cha	56	Dance Pop 2
06	Country 1	23	Swing 5	40	Rhumba	57	Dance Pop 3
07	Country 2	24	Swing 6	41	Beguine	58	Dance Pop 4
08	Broadway	25	Jazz Ballad	42	Mambo	59	16 Beat 1
09	Baroque	26	Dixieland 1	43	Salsa	60	16 Beat 2
10	Waltz 1	27	Dixieland 2	44	Samba 1	61	16 Beat 3
11	Waltz 2	28	Bounce 1	45	Samba 2	62	16 Beat 4
12	Waltz 3	29	Bounce 2	46	Samba 3	63	16 Beat 5
13	Waltz 4	30	Bounce 3	47	Bossanova 1	64	16 Beat Funk 1
14	Waltz 5	31	Reggae 1	48	Bossanova 2	65	16 Beat Funk 2
15	Jazz Waltz 1	32	Reggae 2	49	Bossanova 3	66	16 Beat Funk 3
16	Jazz Waltz 2	33	Slow Rock 1	50	8 Beat 1		
17	Jazz Waltz 3	34	Slow Rock 2	51	8 Beat 2		

Examples of Fill In, Intro./Ending

01F	March 1 Fill In
01I	March 1 Intro.
01E	March 1 Ending

Examples of User

U1A	User 1 A
U1B	User 1 B
U1C	User 1 C
U1D	User 1 D
U1F	User 1 Fill In
U1I	User 1 Intro. *
U1E	User 1 Ending **

* The Intro. selected in the Accompaniment page when in the Rhythm Pattern Program.

** The Ending selected in the Accompaniment page when in the Rhythm Pattern Program.

3

If you wish to enter a Fill In, Intro, or Ending pattern, hold down the appropriate rhythm control button on the panel (INTRO. ENDING or FILL IN) and simultaneously press the Data Control button corresponding to SET.

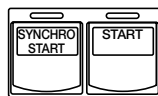

1. While holding down INTRO. ENDING or FILL IN...

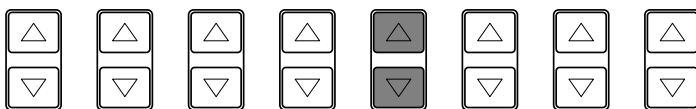
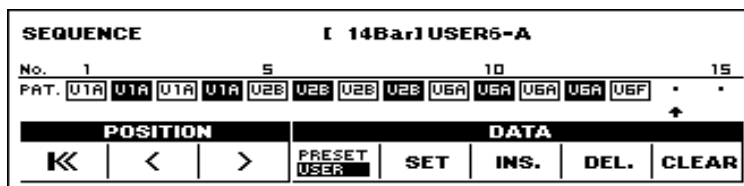

2. ...press SET



Any existing pattern data that follows an Ending pattern is automatically deleted.

Entering Intro. And Ending Patterns:

Pressing the INTRO. ENDING button when at the first position in the pattern row automatically enters an Intro pattern there. Pressing the INTRO. ENDING button at any other position in the row enters an Ending pattern.

4

Use the cursor controls to move the cursor along the pattern row in the display and select the position at which patterns will be entered. Then use the data controls to enter and delete pattern numbers in the pattern row.

SEQUENCE Page

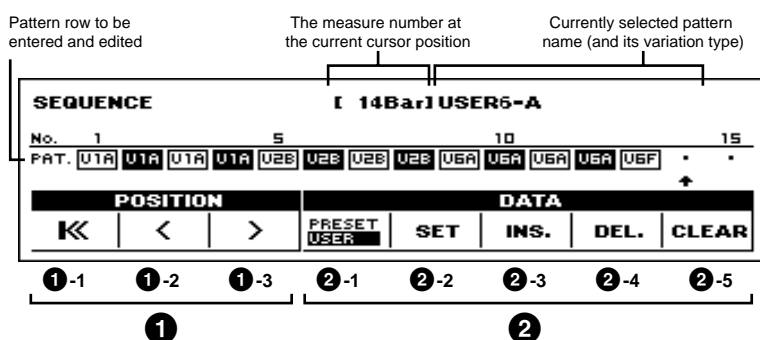

NOTE:

An Intro or Fill In pattern entered to the first position is not registered as a measure, and the current measure display shows “-Bar” even though a pattern has been entered.



NOTE:

The Coarse button can also be used with the cursor controls to move the cursor several steps at a time.



NOTE:

To create your own rhythm sequence you need to assign the rhythms you use to the rhythm buttons and dotted buttons on the panel beforehand.

1 Cursor Controls

- 1-1 |<< Moves the cursor to the first position.
- 1-2 < Moves the cursor one measure to the left.
- 1-3 > Moves the cursor one measure to the right.

2 Data Controls

2-1 PRESET/USER

Selects the type of rhythm, Preset or User.

2-2 SET

For initially entering a pattern number to an empty position in the pattern row, or for replacing a pattern at the cursor position.

2-3 INS. (Insert)

For inserting a pattern number before the current cursor position. The new pattern is entered to the cursor position and all other patterns to the right of the cursor are moved to accommodate the new number. The operation is the same as for SET.

2-4 DEL. (Delete)

For deleting a pattern number at the current cursor position.

2-5 CLEAR

For erasing all patterns entered to the selected sequence. After selecting CLEAR, the display for confirmation of the operation appears.

Select [Clear] to clear the currently selected rhythm sequence, or [Cancel] to abort the operation and return to the previous display.

Audition:

You can play the rhythm sequence at any time during the editing process by moving the cursor to the point at which you wish to begin playback and pressing the Rhythm START button.

About Using Registration Memory with the Rhythm Sequence Program:

The rhythms (Rhythm Menu) used to program the sequence can be changed during editing by selecting different registrations. This allows you to create a registration that contains the specific rhythms that you will use in a given sequence, and call up that registration when editing the sequence.

3) Quitting Rhythm Sequence Program

To quit the Rhythm Sequence Program:

Press the SEQUENCE button in the DISPLAY SELECT section once again. (The LED of the button will turn off.)

4) Playing Rhythm Sequences

To play any of the rhythm sequences you have created:

1 Press the appropriate Sequence button on the panel.

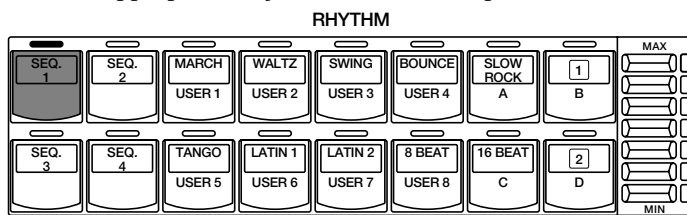

2 Press the rhythm START button.

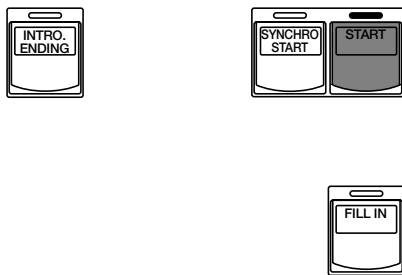

When one of the four rhythm sequences is playing, each programmed rhythm that plays is indicated by the lit LED on the Rhythm panel button.

When a Preset rhythm is playing, the current pattern button's LED is lit.

When a User rhythm is playing, the LEDs of two pattern buttons (User number and its type) are lit.

5) Playing All Sequences in Order

You can also have up to all four rhythm sequences automatically play in order, one after the other.

To do this:

- 1 Press the desired Sequence buttons, making sure that their LEDs are all lit.

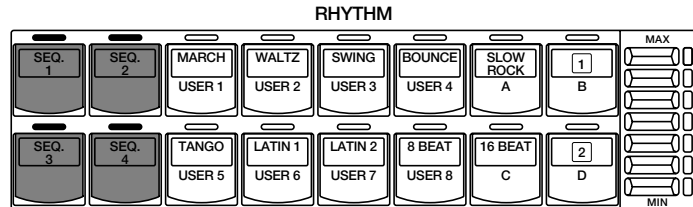

- 2 Press the START button.

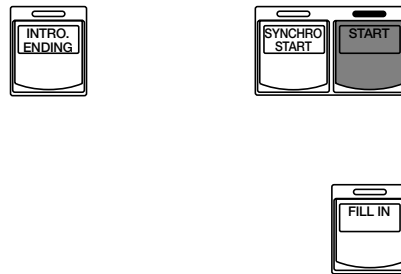

NOTE:

The SEQ. lamp goes out when the sequence assigned to it is finished.



NOTE:

ÉPressing the SEQ. button during the playback of the rhythm sequence that is made up of several sequences (SEQ. buttons) cancels the current sequence and start the next sequence.

The rhythm sequences start from the lowest number and play in order automatically to the highest number. (For example, if you press Sequence buttons 4, 2 and 1 in that order, the sequences will be played back in their numeric order: 1, 2, then 4.) This function effectively allows you to make a long rhythm sequence that exceeds the 120-pattern memory limit of a single sequence.

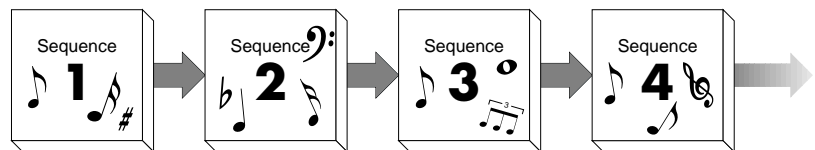

To start the sequence using the Left Footswitch:

- 1 Select STOP from the RHYTHM CONTROL (page 148) on the FOOTSWITCH-LEFT display.
- 2 Press the Left Footswitch with your right foot to turn the sequence on. Pressing the Left Footswitch again in the middle of the sequence playback cancels the rhythm sequence function.



NOTE:

When you are playing the rhythm sequence that is made up of several sequences (SEQ. buttons), pressing the Left Footswitch turns off the currently played-back rhythm sequence and pressing it again starts the next sequence.

Saving Rhythm Pattern and Rhythm Sequence Data to Disk:

Once you have created your own rhythms and rhythm sequences, you'll want to save them to disk. Doing so allows you to free up memory in the Electone for creating additional rhythms and sequences. Also, the User rhythms and sequences you've saved to disk can be loaded back to the Electone any time.

Rhythm Pattern and Rhythm Sequence data are included in the bulk data that is saved when you record registrations to disk. Refer to the section Recording Registrations, page 93, for instructions.

Loading Rhythm Pattern and Rhythm Sequence Data from Disk:

The Rhythm Pattern and Rhythm Sequence data saved to disk as a part of bulk data, can instantly be loaded back to the Electone. Refer to the section Recalling Recorded Registrations, page 94, for instructions.



NOTE:

When loading your original Rhythm Program data back to the Electone, be sure to stop the rhythm if it is playing. Loading cannot be executed when a rhythm is running.

10 Footswitches, Knee Lever and Expression Pedals

These leg- and foot-operated controls allow you to turn on and execute various performance functions without taking your hands from the keyboards.

1 Footswitch

The Electone has two Footswitches on the main expression pedal that can be used to control various functions. The Right Footswitch is used for the Registration Shift functions (page 79). The Left Footswitch can be set to control one of the following functions: Glide, Tremolo, rhythm controls.

Assignments of the functions are made in the FOOTSWITCH pages.

To select the Footswitch pages:

Press the FOOT SW. button in the DISPLAY SELECT section.

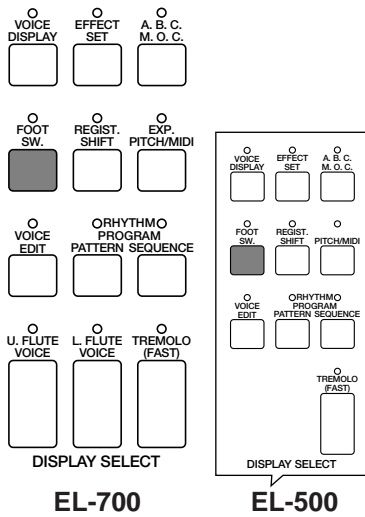

FOOTSWITCH-LEFT page



OFF

Cancels Left Footswitch control.

1) Rhythm Control

Selection of Left Footswitch control over rhythm functions. When this is chosen, the following display appears:

FOOTSWITCH-LEFT Page—Rhythm				
FOOT SWITCH-LEFT				
MODE		RHYTHM CONTROL		
OFF	RHY THM	STOP	END ING	FILL IN
GLIDE	TRE MOLO			

①
②
③

One of the three Rhythm Control functions can be selected. Pressing the Footswitch executes the corresponding function.

- ① **STOP**
Functions as an on/off switch for the rhythm or the rhythm sequence.
- ② **ENDING**
Switches the rhythm to the Ending pattern, after which the rhythm is stopped.
- ③ **FILL IN**
Switches the rhythm to the Fill In pattern.

2) Glide Control

Selection of Footswitch control over Glide. Pressing the Footswitch immediately lowers the pitch of the selected voice or voices by a halfstep, and releasing it slowly returns the pitch to the original. When the Glide setting is chosen, the following display appears:

FOOT SWITCH-LEFT Page—Glide					
FOOT SWITCH-LEFT					
MODE		GLIDE CONTROL			
OFF	RHY THM	UPPER 1	UPPER 2	LEAD	TIME
GLIDE	TRE MOLO	LOWER 1	LOWER 2		---

①
②

- ① **Voice Sections/GLIDE CONTROL**
The Glide function can be applied to any or all of the voice sections shown in the display: Upper 1 and 2, Lead, Lower 1 and 2. Select the desired voice section(s).
- ② **TIME**
Determines the speed of the Glide function, or in other words, how gradually the pitch returns when the Footswitch is released. Higher settings produce slower pitch changes.



NOTE:

When the Glide function is applied, the Vibrato is not effective.

3) Tremolo Control

Selection of Footswitch control over Tremolo. Pressing the Footswitch turns the Tremolo effect on and off (Chorus), performing the same function as the TREMOLO (FAST) button in the DISPLAY SELECT section.

If you want to use this function, the tremolo settings require to be set properly. See page 53 for more information.

FOOT SWITCH-LEFT Page—Tremolo



2 Knee Lever

The Knee Lever, located on the underside of the keyboard panel, can be used to turn on and off the Sustain effect, Melody On Chord function and Lead Slide effect.

1) Sustain

To select Knee Lever control over Sustain:

- 1 Make sure that the Upper and/or Lower Sustain effect panel controls have been turned on; otherwise the Knee Lever will have no effect.

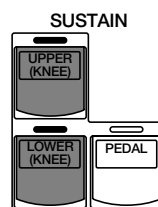

- 2 Fold the Knee Lever down.

- 3 Press the Knee Lever to the right with your knee when you want to have sustain.

1 When the Knee Lever is folded up:

The sustain effect is applied constantly, as long as the front panel sustain buttons are on.

2 When the Knee Lever is vertical:

The sustain effect is cancelled.

3 When the Knee Lever is continuously pressed to the right:

The sustain effect is on.

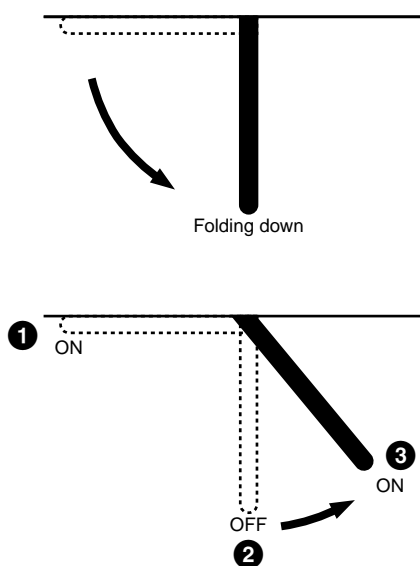

2) Melody On Chord

To select Knee Lever control over Melody On Chord:

- 1 Press the A.B.C./M.O.C. button in the DISPLAY SELECT section to select the A.B.C./M.O.C. page.
- 2 Then set the KNEE control to ON, and select one of the modes.

AUTO BASS CHORD			MELODY ON CHORD		
MODE		MEM.	MODE		KNEE
OFF	Single Finger	LOWER	OFF	1	ON
Finger Chord	Custom A.B.C.	PEDAL	2	3	OFF
- 3 Press the Knee Lever continuously to the right to get the Melody On Chord effect in the middle of the performance.

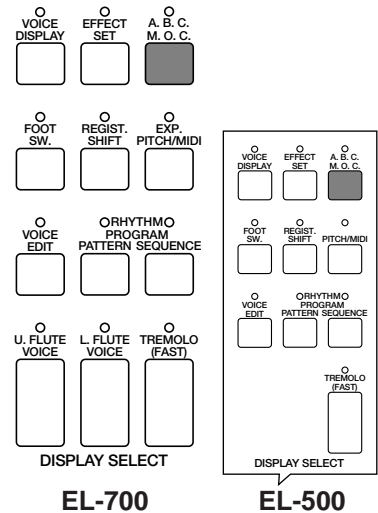

NOTE:

If the KNEE is set to ON, the Melody On Chord cannot be applied without using the Knee Lever.

3) Lead Slide

To select Knee Lever control over Lead Slide:

- 1 Call up the Lead Condition display, by pressing a Lead Voice button twice (or the Data Control button corresponding to a Lead voice).
- 2 Select PAGE 3 by pressing Page buttons.

LEAD VOICE							PAGE: 1-2-3	
Violin1								
VIBRATO			TOUCH VIB.		SLIDE		TUNE	
PRESET USER	DELAY	DEPTH	SPEED	ON OFF	ON KNEE OFF	TIME	6	
- 3 Then select KNEE and set the TIME parameter in the SLIDE controls.
- 4 Press the Knee Lever continuously to the right to get the Lead Slide effect in the middle of the performance.



NOTE:

If the KNEE is set to ON, the Lead Slide cannot be applied without using the Knee Lever.

3 Expression Pedals

There are two types of Expression Pedals: the Expression Pedal which controls the volume during performance with your toe, and the 2nd Expression Pedal (EL-700 only) which can control the Pitch Bend and Tempo.

Second Expression Pedal (EL-700 only) —Pitch Bend And Tempo

To select the 2nd Expression page:

Press the EXP. PITCH/MIDI button in the DISPLAY SELECT section.

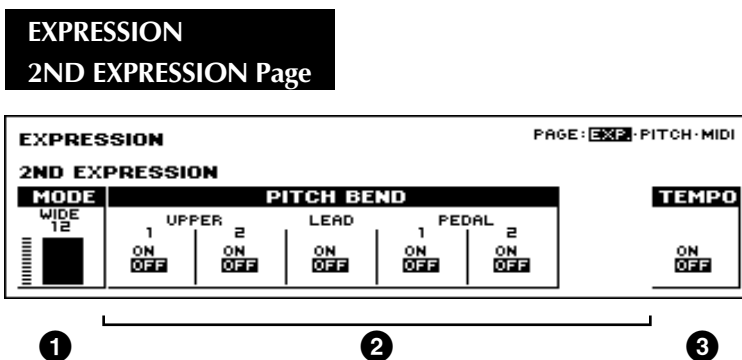
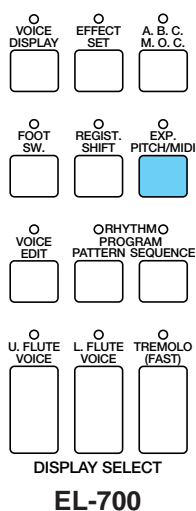

Pitch Bend Control

1 MODE

Determines the range of the Pitch Bend control. Range: 1 - 12
The setting 2 (NARROW) results in a small amount of pitch variation (within \pm two semitones); the setting 12 (WIDE) results in a large amount of pitch variation (within \pm one octave). (This control is the same as for Tempo below; the two cannot be used independently.)

2 Voice Sections/PITCH BEND

Selects the voice sections to which the Pitch Bend function will be applied. Pitch Bend can be selected independently or together for Upper Voices 1 and 2, Lead Voice, Pedal Voices 1 and 2.
When on, pressing the pedal with your toe raises the pitch; pressing it with your heel lowers the pitch.

Tempo Control

1 MODE

Determines the range of the Tempo control. Range: 1 - 12
The setting 2 (NARROW) results in a small amount of tempo variation (70%-140%); the setting 12 (WIDE) results in a large amount of tempo variation (50%-200%). (This control is the same as for Pitch Bend above; the two cannot be used independently.)

3 TEMPO

On/off switch for control over the rhythm tempo. When on, pressing the pedal with your toe speeds up the tempo; pressing it with your heel slows it down. Releasing the pedal from either position causes it to return to center, restoring the original tempo.



NOTE:

Don't use the Pitch Bend and Tempo at the same time since you may inadvertently apply both two controls at once.

Transpose and Pitch Controls

There are two pitch-related controls on the Electone: Transpose and Pitch. Transpose allows you to change the key of the instrument and Pitch lets you finely adjust the tuning. These features make it easy to change the key of a song to accommodate a vocalist's range or to precisely match the tuning of another instrument.

To select the Pitch page:

Press the EXP. PITCH/MIDI button (PITCH/MIDI button for EL-500) in the DISPLAY SELECT section, and (if necessary,) select the Pitch page with the Page buttons.

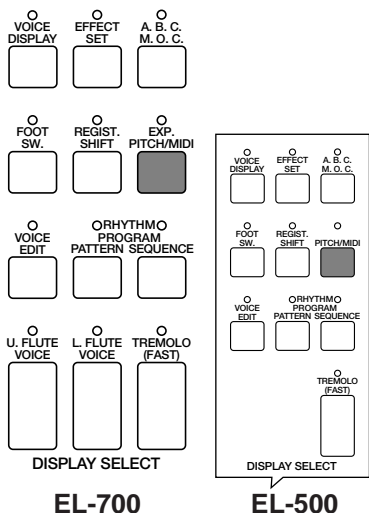

PITCH CONTROL Page

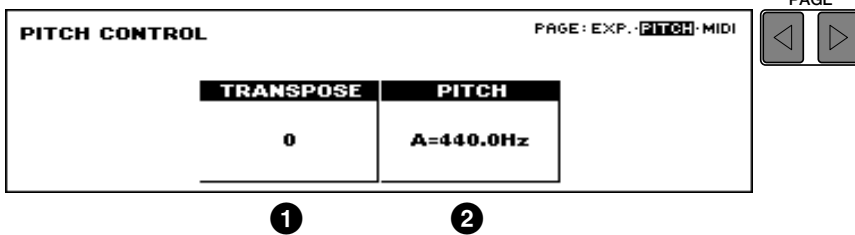

1 TRANSPOSE

Determines the coarse pitch setting of all the voices, and is adjustable in half-steps (semitones). Range: -6 - +6 (one octave)

2 PITCH

Determines the fine pitch setting of all the voices. Range: 438.8 - 444.5Hz (Ca. a quarter semitone)



NOTE:

The default Pitch is 440.0Hz (=A3).



NOTE:

The pitch changes cannot be recorded to the Music Disk Recorder.

About the Pitch

Each voice is tuned with the temperament.

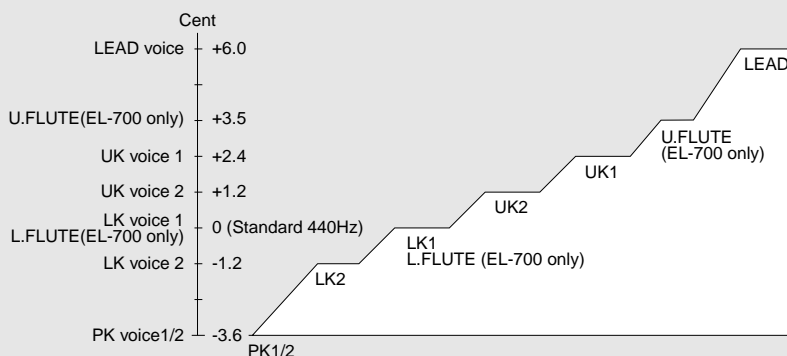

NOTE:

When matching the pitch with other instrument, use the Clarinet voice on the Lower keyboard.

MIDI (Musical Instrument Digital Interface) is a kind of communication system for electronic musical instruments. It is built into most every modern digital musical instrument and allows different instruments to “talk” to each other and control each other’s functions. For example, the Upper keyboard of your Electone could be used to play sounds on a connected synthesizer. In another application, a rhythm machine can be programmed to play its rhythms in perfect synchronization with the tempo set on the Electone. To use the MIDI functions you must, of course, have a second MIDI device (such as a synthesizer or rhythm machine), and a set of MIDI cables. For more information see page 158.

To select the MIDI page:

Press the EXP. PITCH/MIDI button (PITCH/MIDI button for EL-500) in the DISPLAY SELECT section, and select the MIDI page with the Page buttons.

MIDI CONTROL Page

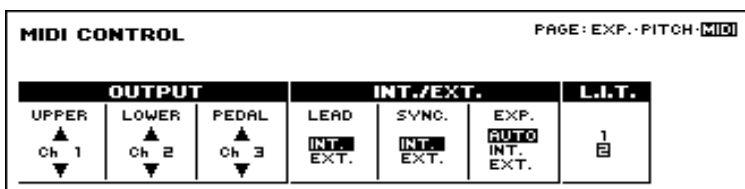

1

1 Output (Transmit) Channels

For setting the channels over which MIDI information will be transmitted. Any channel from 1 through 16 can be assigned to each keyboard, the Upper keyboard, the Lower keyboard and the Pedalboard

UPPER: 1 - 16

LOWER: 1 - 16

PEDAL: 1 - 16

The MIDI receive channel of each connected MIDI device should match the numbers set here.

Receive Channels

When using another MIDI device to play the Electone’s voices, you must set the MIDI transmit channel(s) of the connected device to match the receive channel(s) of the Electone. The MIDI receive channels of the Electone are fixed to the following values:

Upper= 1, Lower= 2 and Pedal= 3.

The MIDI transmit channel of each connected MIDI device should match the above numbers.

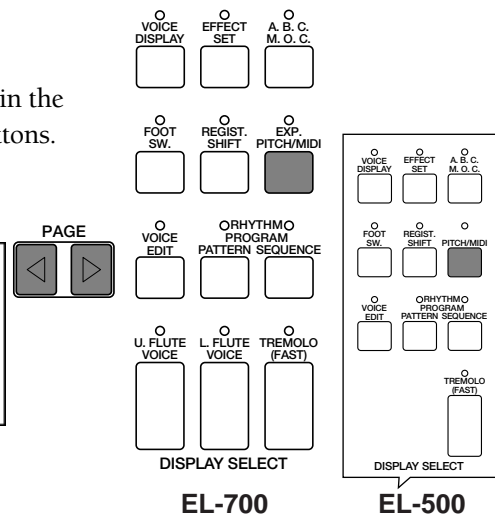

EL-700

EL-500

MIDI CONTROL Page

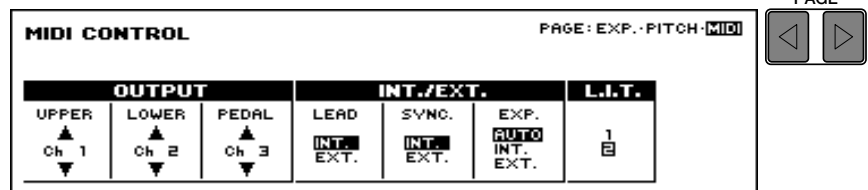

NOTE:

Accompaniment pattern sounds cannot be controlled via MIDI.

Internal/External Control

1 LEAD

Determines Internal or External control of the Lead Voices. When set to Internal, Lead Voices are played from the Electone and the sounds from a connected MIDI instrument can be played via MIDI channel 1 (or channel 2, when the To Lower function is on). When set to External, the Lead Voices can only be played from the connected instrument via MIDI channel 4.

2 SYNC.

Determines the source of the timing control, for rhythm synchronization purposes. Setting this to Internal gives the Electone timing control over the connected rhythm machine. This also allows you to start and stop the rhythms of the connected rhythm machine from the Electone's panel controls. Setting this to External gives timing control to the connected rhythm machine.

3 EXP.

Determines the control of the expression pedal functions. Ordinarily, this control is set to Auto. However, when it is set to INT., you can manually control the expression pedal functions during M.D.R. playback. When set to EXT., another (external) Electone controls over the expression pedal functions.



NOTE:

This control has no relation to MIDI.

L.I.T. (Lead Initial Touch) Control

At the right side of the MIDI page, there is the L.I.T. control.

L.I.T. 1:

When descending notes are played in legato with the monophonic lead voices, the last note played has the same initial touch response as the previous note.

L.I.T. 2:

Default setting. When descending notes are played in legato with the monophonic lead voices, the last note played sounds according to the velocity at which it is played.

13 Accessory Jacks and Controls

On the underside of the Electone keyboard is a separate panel equipped with various input/output terminals and miscellaneous controls, the functions of which are described below.

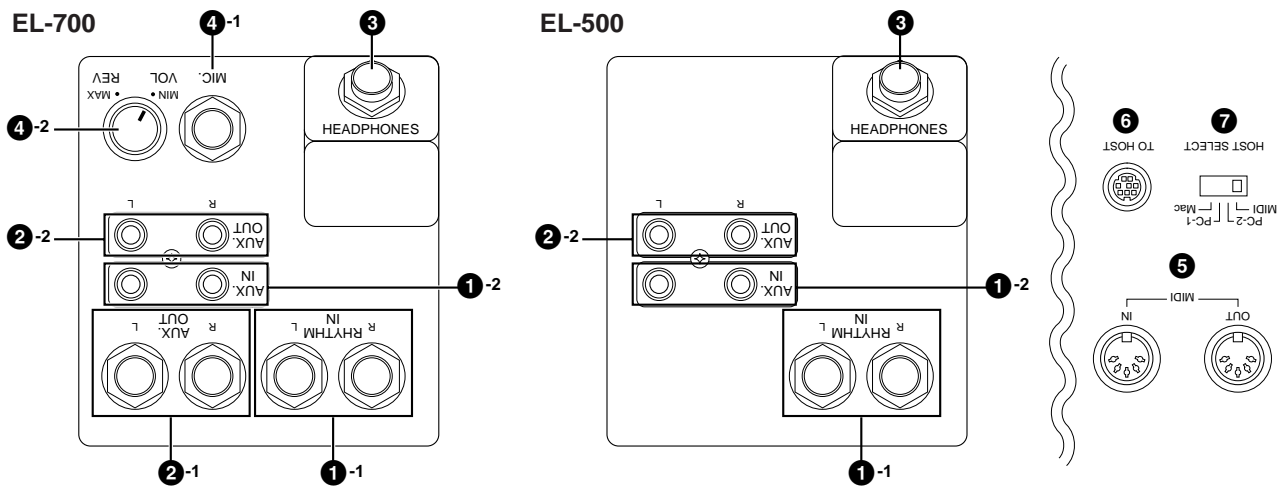

1 Input Jacks

1-1 RHYTHM IN (Phone, L/R)

This pair of phone jacks are for connection to an external rhythm machine. The sound of the connected device is mixed with the sound of the Electone and played through the Electone's speaker system. The volume of the rhythm machine can be controlled by the Expression pedal of the Electone.

1-2 AUX. IN (RCA, L/R)

This pair of RCA pin jacks are for connection to an external stereo sound source, such as a cassette deck or home audio system. The sound of the connected device is mixed with the sound of the Electone and played through the Electone's speaker system. Adjust the level by using the control(s) on the connected device.

2 Output Jacks

2-1 AUX. OUT (Phone, L/R) [EL-700 only], 2-2 AUX. OUT (RCA, L/R)

These two separate sets of stereo outputs are for connection to external amplification/speaker systems.

3 HEADPHONES (Phone)

For connection of a stereo headphone set. When headphones are connected to this jack, sound to the Electone's built-in speaker system is automatically cut off, allowing you to play without disturbing others.

4 Microphone (EL-700 only)

4-1 MIC. (Phone)

For connection of a microphone.

4-2 MIC. VOL.

For adjusting the level of the microphone input.

5 MIDI IN/OUT

For connecting external devices such as synthesizer and rhythm machine with MIDI cables.

6 TO HOST

This terminal can be connected to the serial port of a personal computer instead of using MIDI connection.

7 HOST SELECT

When you have connected the Electone and the personal computer using the TO HOST terminal, you need to select the appropriate setting here depending on the computer used.



NOTE:

See page 158 for the details of the connection using the TO HOST terminal.

MIDI

MIDI is an acronym that stands for **Musical Instrument Digital Interface**, which allows electronic musical instruments to communicate with each other, by sending and receiving MIDI messages.

On the right underside of the Electone keyboard you will find the MIDI IN/OUT jacks and TO HOST terminal. If your Electone is connected with external devices via these MIDI jacks (with a personal computer via the TO HOST terminal) and appropriate MIDI settings are done, you can play an external MIDI device such as synthesizer from your Electone keyboard or your Electone can be played by an external device such as sequencer (by a personal computer with a sequencing software installed).

To connect your Electone with an external MIDI device you need to prepare a pair of MIDI cables (or a serial cable when you connect the Electone with a personal computer via the TO HOST terminal).

Also, to exchange the data between your Electone and connected MIDI device you have to match the MIDI transmit/receive channels on both devices. See page 155 for the detailed information about the MIDI channel settings.



NOTE:

See page 160 for more information on the MIDI messages.

Setting examples

Using the TO HOST terminal

If you want to connect your Electone with a personal computer, a MIDI interface will be necessary. However, using a separately available Serial Cable allows you to directly connect them (between the TO HOST terminal of your Electone and the Serial Port of the personal computer). In this case you need to select one of the HOST SELECT switches to match the computer type you use.



NOTE:

MIDI jacks will be inactive when the TO HOST terminal is currently used.

IBM PC/AT

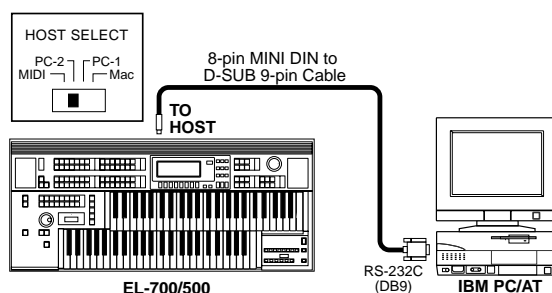

Macintosh

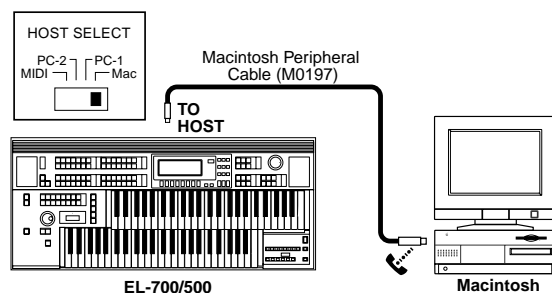

NOTE:

For Windows users: To actually exchange the data via the Serial Cable you need to install the included MIDI driver (Yamaha CBX Driver) to your personal computer in advance.



NOTE:

Select the HOST SELECT switches as follows:

- When you use MIDI connection: MIDI
- When you use TO HOST connection with Windows system: PC-2
- When you use TO HOST connection with Macintosh: Mac

Using MIDI IN/OUT jacks

Controls an external device using the EL-700/500 (as a master)

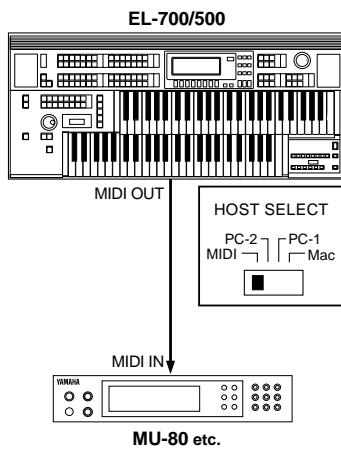

Controls the EL-700/500 using an external device (as a slave)

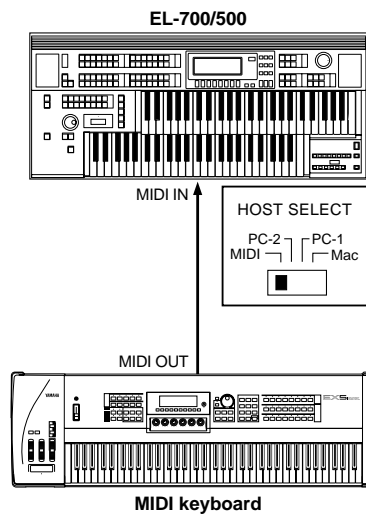

Exchanges the data between EL-700/500 and an external device

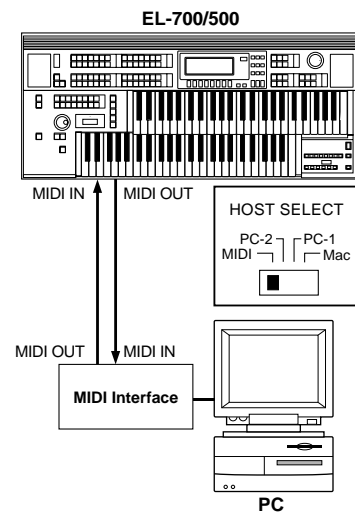

1. Control an external device using the EL-700/500

- Playing your Electone can cause the MIDI keyboard (or tone generator) to be played using its own voices, accomplishing thick sound layers. (The MIDI receive channel of the MIDI keyboard must match the transmit channel of your Electone.)
- Various messages including the values how far the expression pedal is pressed down and how hard you play the Electone keyboard can be transmitted as digital data. However, whether and how the external device responds or not depends on the external device you have connected.
- The performance on the EL-700/500 can be recorded onto your personal computer using a sequencing software.

2. Control the EL-700/500 using an external device

- Playing the external MIDI keyboard can cause your Electone to be played using Electone's voices. (The MIDI transmit channel of the MIDI keyboard must match the receive channel of your Electone. The channels 1, 2 and 3 for the Upper, Lower and pedal voices, respectively.)
- EL-700/500 can be played as a rhythm machine by playing the external MIDI device. (The MIDI transmit channel of the MIDI keyboard should be 15, in this case.)
- EL-700/500 will work as an XG tone generator and play back the MIDI data transmitted from the personal computer (a sequencing software). See page 166 for the details to use the EL-700/500 as an XG tone generator.



You cannot use the M.D.R. and MIDI function at one time since the M.D.R. is also connected via MIDI internally.

The MIDI Messages of the EL-700/500

The MIDI messages can be divided into two groups: the Channel Messages and System Messages. Below is an explanation of the various types of MIDI messages which the EL-700/500 can receive/transmit.

Channel Messages

The Channel Messages are the data related to the performance on the keyboard for a specific channel. Each time you play the keyboard on the EL-700/500, the channel messages, which keys are played and how hard the keys are pressed, will be transmitted via a specific channel. The channel messages from an external keyboard can be received by the EL-700/500 and thus you can play the EL-700/500 from an external keyboard.

Note On

Indicates which keys are played with the note numbers 0 through 127. The reception note range is C-2 (0) – G8 (127), C3 = 60.

Velocity

Indicates how hard the key is held. The range is 1 – 127.

Note Off

Generated when a key is released.



NOTE:

For more detailed information see MIDI Data Format on page 164 and MIDI Implementation Chart on page 175.



NOTE:

For more detailed information on the Control Change messages available for the EL-700/500 see MIDI Data Format on page 164 and MIDI Implementation Chart on page 175.

Program Change

The Program Change messages allow you to change voices in the middle of a song. With these messages you can change the registrations of the EL-700/500.

Control Change

The Control Change messages let you select a voice bank, control volume, panning, modulation, portamento time, brightness and various other controller parameters, through specific Control Change numbers which correspond to each of the various parameters.

System Messages

The System Messages are the data related to the overall system of the device.

System Exclusive Messages

System Exclusive messages are used to exchange the system and voice/registration data. These allow you to execute bulk dump operation, sending and receiving all the data of the EL-700/500 including registrations to and from an external device. This is especially useful for you to build up the library of the registration data in a device like a hard disk.

Examples of Exchanging the Data

Use the following examples to send (or receive) the registration data to (or from) a personal computer (a sequencing software).

First, you need to connect your EL-700/500 with a personal computer (a sequencing software) using a Serial Cable or a MIDI cable (page 158).



NOTE:

You also need a sequencing software, which has been properly installed in the personal computer, and which can send and receive system exclusive messages.

Send the Registration Data from the EL-700/500 to the Personal Computer (PC)

• Preparation

- 1 Set the Strings voice on the Upper Keyboard of the EL-700/500. Press STRINGS button for the Upper Keyboard Voice 1 section, and select String 1 from the Strings Menu.
- 2 Store the registration to the Registration Memory button 1. While holding down the M. button Press the Registration Memory button 1.

• Sending the Registration Data

- 3 Send the Request-to-Send all RAM message, "F0, 43, 70, 70, 10, F7" (Hexadecimal), from the sequencing software (PC) to the EL-700/500.

Once the EL-700/500 receive the Request-to-Send all RAM message, the EL-700/500 automatically sends all registration data in the all registration numbers to your PC. You can store the registration data in a file on your PC.



NOTE:

Depending on the capacity of your sequencing software, you may need to divide the data into two and send them to the PC separately.

Send the Registration Data from your PC to the EL-700/500 and Change the Registration Memory Buttons

• Receiving the Registration Data

1 Send the Request-to-Receive all RAM message, “F0, 43, 70, 70, 20, F7” (Hexadecimal), from the sequencing software (PC) to the EL-700/500.

Once the EL-700/500 receive the Request-to-Receive all RAM message, the EL-700/500 automatically receives all registration data and relocates them to the all registration numbers.

• Selecting the Registration Memory Buttons

Sending the Program Change messages from the PC to your EL-700/500 makes it possible to change the registration on the EL-700/500.

2 Send the Program Change message, “CF, 00” (Hexadecimal) to the EL-700/500.

Once the Program Change message is received, the EL-700/500 automatically turns the Registration Memory button 1 on.

• Sending the Note-On Messages

3 Send the Note-On message, “90, 30, 7F” (Hexadecimal) to the EL-700/500.

The EL-700/500 receives the Note-On message and plays the C2 key on the Upper Keyboard using the Strings 1 you have selected on the previous page.

All the above operations can also be done with the M.D.R. easily and efficiently. However, using the PC/ hard disk allows you to build up a large data library a single disk cannot deal with.

Use the EL-700/500 as an XG Tone Generator

You can also use the EL-700/500 as an XG tone generator since the EL-700/500 is compatible with the XG format. You can play back the commercially available XG song data with the electone's M.D.R., and also play them using an external sequencer (or sequencing software) and the internal XG tone generator.

The internal tone generator section of the EL-700/500 is normally set to EL Mode for playing as an "Electone."

Sending an appropriate system exclusive message from the sequencing software (PC) to the EL-700/500 changes the mode to XG Mode, in which you can use the Electone as an XG tone generator.

1 Send the XG System On message, "F0, 43, 1N, 4C, 00, 00, 7E, 00, F7" (Hexadecimal), from the sequencing software (PC) to the EL-700/500.

* N: Device Number ("0" for the EL-700/500)

Once the XG System On message is received, the internal tone generator will be in the XG Mode allowing the EL-700/500 to all the MIDI messages defined by the XG format such as NRPN and Bank Select.



NOTE:

The M.D.R. section of the EL-700/500 allows you to play back the commercially available XG song data and convert the data created by the EL-700/500 to the XG compatible data. See page 97 for more information.



NOTE:

When you create an XG song data using a sequencing software, be sure to insert the XG System On message at the beginning of the data. The internal tone generator mode automatically changes to XG when you start to play back the data.



NOTE:

The internal tone generator mode automatically changes to XG when you play back commercially available XG song data.

MIDI Data Format

1. Channel Messages

1.1 EL Mode

Code (Hexadecimal)	Function	Transmit	Receive	Remarks
8n,nn,00-7F	Note Off	×	1ch	UK
		×	2ch	LK
		×	3ch	PK
		×	(4ch)*	LEAD
		×	5-14ch	XG
		×	15ch	Keyboard Percussion
9n,nn,00	Note Off	(1ch)*	1ch	UK
9n,nn,01-7F	Note On	(2ch)*	2ch	LK
		(3ch)*	3ch	PK (EL-500: note on transmit velocity=50H)
		×	(4ch)*	LEAD
		×	5-14ch	XG
		×	15ch	Keyboard Percussion
Bn,00,00-7F	Bank select	×	5-14ch	XG
Bn,20,00-7F				
Bn,01,00-7F	Modulation	×	5-14ch	XG
Bn,04,00-7F	2nd Expression	16ch	16ch	Control
		(4ch)**	(4ch)*	LEAD
Bn,05,00-7F	Portamento Time	×	5-14ch	XG
Bn,06,00-7F	Data Entry	×	5-14ch	XG
Bn,26,00-7F				
Bn,07,00-7F	Volume	×	5-14ch	XG
Bn,0A,00-7F	Pan	×	5-14ch	XG
Bn,0B,00-7F	Expression	16ch	16ch	Control
			5-14ch	XG
Bn,40,00-7F	Hold	×	5-14ch	XG
Bn,41,00-7F	Portamento	×	5-14ch	XG
Bn,42,00-7F	Sostenuto	×	5-14ch	XG
Bn,43,00-7F	Soft Pedal	×	5-14ch	XG
Bn,47,00-7F	Resonance	×	5-14ch	XG
Bn,48,00-7F	Release Time	×	5-14ch	XG
Bn,49,00-7F	Attack Time	×	5-14ch	XG
Bn,4A,00-7F	Brightness	×	5-14ch	XG
Bn,54,00-7F	Portamento Control	×	5-14ch	XG
Bn,5B,00-7F	Reverb Send Level	×	5-14ch	XG
Bn,5D,00-7F	Chorus Send Level	×	5-14ch	XG
Bn,5E,00-7F	Variation Send Level	×	5-14ch	XG
Bn,60,00-7F	Data Increment	×	5-14ch	XG
Bn,61,00-7F	Data Decrement			
Bn,62,00-7F	NRPN LSB	×	5-14ch	XG
Bn,63,00-7F	NRPN MSB			
Bn,64,00-7F	RPN LSB	×	5-14ch	XG
Bn,65,00-7F	RPN MSB			
Bn,78,00	All Sounds Off	×	5-14ch	XG
Bn,79,00	Reset All Controllers			
Bn,7B,00	All Note Off			
Bn,7C,00	Omni Off			
Bn,7D,00	Omni On			
Bn,7E,00	Mono			
Bn,7F,00	Poly			

Code (Hexadecimal)	Function	Transmit	Receive	Remarks
Cn,nn	Program Change	×	1ch	UK
		×	2ch	LK
		×	3ch	PK
		×	5-14ch	XG
		16ch	16ch	Control
Dn,00-7F	After Touch	(1ch)*	1ch	UK
		(2ch)*	2ch	LK
		(3ch)*	3ch	PK (EL-500: not transmit)
			(4ch)*	LEAD
			5-14ch	XG
En,00-7F,00-7F	Pitch Bend	×	5-14ch	XG

* Can be changed in the MIDI settings.

** Can be output when assigned to the channel 4.

1.2 XG Mode

Code (Hexadecimal)	Function	Transmit	Receive	Remarks
8n,nn,00-7F	Note Off	×	1-16ch	
9n,nn,00	Note Off	(1ch)	1-16ch	UK
9n,nn,01-7F	Note On	(2ch)*		LK
		(3ch)*		PK(EL-500: note on transmit velocity=50H)
Bn,00,00-7F Bn,20,00-7F	Bank select	×	1-16ch	
Bn,01,00-7F	Modulation	×	1-16ch	
Bn,04,00-7F	2nd Expression	16ch (4ch)**	×	Control (EL-700 only) LEAD (EL-700 only)
Bn,05,00-7F	Portamento Time	×	1-16ch	
Bn,06,00-7F Bn,26,00-7F	Data Entry	×	1-16ch	
Bn,07,00-7F	Volume	×	1-16ch	
Bn,0A,00-7F	Pan	×	1-16ch	
Bn,0B,00-7F	Expression	16ch	1-16ch	Control
Bn,40,00-7F	Hold	×	1-16ch	
Bn,41,00-7F	Portamento	×	1-16ch	
Bn,42,00-7F	Sostenuto	×	1-16ch	
Bn,43,00-7F	Soft Pedal	×	1-16ch	
Bn,47,00-7F	Resonance	×	1-16ch	
Bn,48,00-7F	Release Time	×	1-16ch	
Bn,49,00-7F	Attack Time	×	1-16ch	
Bn,4A,00-7F	Brightness	×	1-16ch	
Bn,54,00-7F	Portamento Control	×	1-16ch	
Bn,5B,00-7F	Reverb Send Level	×	1-16ch	
Bn,5D,00-7F	Chorus Send Level	×	1-16ch	
Bn,5E,00-7F	Variation Send Level	×	1-16ch	
Bn,60,00-7F	Data Increment	×	1-16ch	
Bn,61,00-7F	Data Decrement			
Bn,62,00-7F	NRPN LSB	×	1-16ch	
Bn,63,00-7F	NRPN MSB			
Bn,64,00-7F	RPN LSB	×	1-16ch	
Bn,65,00-7F	RPN MSB			

Code (Hexadecimal)	Function	Transmit	Receive	Remarks
Bn,78,00	All Sounds Off	×	1-16ch	
Bn,79,00	Reset All Controllers			
Bn,7B,00	All Note Off			
Bn,7C,00	Omni Off			
Bn,7D,00	Omni On			
Bn,7E,00	Mono			
Bn,7F,00	Poly			
Cn,00-7F	Program Change	16ch 1-16ch	Control	
Dn,00-7F	After Touch	(1ch)* (2ch)* (3ch)*	1-16ch	UK LK PK (EL-500 not transmit)
En,00-7F,00-7F	Pitch Bend	×	1-16ch	

* Can be changed in the MIDI settings.

** Can be output when assigned to the channel 4.

2. Realtime Messages

Code (Hexadecimal)	Function	Transmit	Receive	Remarks
F8	Clock	○	○*	
FA	Start	○	○	
FC	Stop	○	○	
FE	Active Sensing	○	○	
FF	Reset	×	×	

* Received only when in the Ext. mode

3. System Exclusive Messages

3.1 Format

Universal Realtime Messages

Code (Hexadecimal)	Message	Transmit	Receive
F0,7F,7F,04,01,SS,TT,F7 XN	XG Master Volume	×	○

Universal Non-Realtime Messages

Code (Hexadecimal)	Message	Transmit	Receive
F0,7E,7F,09,01,F7 XN	GM ON	×	○

XG Native

Code (Hexadecimal)	Message	Transmit	Receive
F0,43,1N,4C,AH,AM,AL,...data...,F7	XG Parameter Change	×	○
F0,43,0N,4C,BH,BL,AH,AM,AL,...data...,cc,F7	XG Bulk Dump	×	○
F0,43,1N,27,30,00,00,MM,LL,cc,F7	XG Master Tuning	×	○
F0,43,1N,4C,00,00,7E,00,F7	XG System On	×	○

Electone/Single Keyboard Common Messages

Code (Hexadecimal)	Message	Transmit	Receive
F0,43,73,01,02,F7 03	Request for Internal Synch. Mode	×	○
	Request for External Synch. Mode	×	○

Electone Exclusive

Code (Hexadecimal)	Message	Transmit	Receive
F0,43,70,70,00,...(Data)...F7 78 ID	Bulk Dump Data	X O X	O O O
F0,43,70,ID,00,F7	Model ID Data	O	X
F0,43,70,70,nn(*1),F7 78 ID	Request-to-Send Data	X X X	O O O
F0,43,70,70,nn(*2),F7 78 ID	Request-to-Receive Data	X X X	O O O
F0,43,70,70,01,ID1,ID2,SPI,SPh,DCI,DCh,F7 78 ID	Request-to-Send Voice parameter data	X X X	O O O
F0,43,70,70,02,ID1,ID2,SPI,SPh,DCI,DCh,F7 78 ID	Request-to-Receive Voice parameter data	X X X	O O O
F0,43,70,70,30,F7	Request-to-Send Model ID data	X	O
F0,43,70,70,38,7F,F7 00	Bulk Dump Acknowledge Bulk Dump Unacknowledge	X O	X X
F0,43,70,70,40,nn(*3),7F,F7 00	Switch On Switch Off	O O	O O
F0,43,70,70,40,50,TL,TH,F7	Tempo	O	O
F0,43,70,78,41,cd,dd,F7(*4)	Panel Switch Events	O	O
F0,43,70,78,42,...(Data)...F7	Current Registration Data	O	O
F0,43,70,78,44,...(Data)...(*5),F7	EL MIDI Parameters	O	O
F0,43,70,70,70,nn(*6),F7	External MDR	X	O
F0,43,70,70,73,F7	EL ON	X	O
F0,43,70,70,78,SC,NC,F7	Bar Signal		

X : don't care N : Device Number("0" on EL-700/500) ID=47 on EL-700, 48 on EL-500

*1 Data Codes to Send

nn	Data
10	All RAM
11	Registrations
12	Rhythm Sequences
14,15	User Patterns
16	User Voices
17	Keyboard Percussion Assignments

*2 Data Codes to Receive

nn	Data
20	All RAM
21	Registrations
22	Rhythm Sequences
24,25	User Patterns
26	User Voices
27	Keyboard Percussion Assignments

*3 Switches

nn	Switch	Transmit	Receive
45	Left Footswitch	O	O
47	Knee Lever	O	O
48	Fill In 1	O	O
4B	Intro./Ending	O	O

*4 Switch Codes

Selectors

Code	Switch	Transmit	Tx Range	Receive	Rx Range	Remarks
02	UK Voice 1	○	[00-0D]	○	[00-0D]	Switch Number
03	LK Voice 1	○	[00-0D]	○	[00-0D]	Switch Number
04	UK Voice 2	○	[00-0D]	○	[00-0D]	Switch Number (transmit value for EL-500: [00-01])
05	LK Voice 2	○	[00-0D]	○	[00-0D]	Switch Number (transmit value for EL-500: [00-01])
06	LEAD Voice	○	[00-04]	○	[00-04]	Switch Number
07	Pedal Voice 1	○	[00-04]	○	[00-04]	Switch Number
08	Pedal Voice 2	○	[00-04]	○	[00-04]	Switch Number (transmit value for EL-500: [00-01])
0B	Rhythm	○	[00-0B]	○	[00-04]	Switch Number
0F	Registration Memory	×		○	[00-0F]	

Volume

Code	Switch	Transmit	Tx Range	Receive	Rx Range	Remarks
12	UK Voice 1	○	[00-7F]	○	[00-7F]	Volume Data 00:MAX,7F:MIN
13	LK Voice 1	○	[00-7F]	○	[00-7F]	Volume Data; 00:MAX,7F:MIN
14	UK Voice 2	○	[00-7F]	○	[00-7F]	Volume Data; 00:MAX,7F:MIN
15	LK Voice 2	○	[00-7F]	○	[00-7F]	Volume Data; 00:MAX,7F:MIN
16	LEAD Voice	○	[00-7F]	○	[00-7F]	Volume Data; 00:MAX,7F:MIN
17	Pedal Voice 1	○	[00-7F]	○	[00-7F]	Volume Data; 00:MAX,7F:MIN
18	Pedal Voice 2	○	[00-7F]	○	[00-7F]	Volume Data; 00:MAX,7F:MIN
1A	Rhythm	○	[00-7F]	○	[00-7F]	Volume Data; 00:MAX,7F:MIN
1B	Reverb	○	[00-7F]	○	[00-7F]	Depth Data; 00:MAX,7F:MIN

Flute Voice (EL-700 only)

Code	Switch	Transmit	Tx Range	Receive	Rx Range	Remarks
30	Upper Flute Voice	○	[00-01]	○	[00-01]	00:OFF,01:ON
31	Lower Flute Voice	○	[00-01]	○	[00-01]	00:OFF,01:ON

To Lower

Code	Switch	Transmit	Tx Range	Receive	Rx Range	Remarks
36	LEAD Voice	○	[00-01]	○	[00-01]	00:OFF,01:ON
37	Pedal Voice 1	○	[00-01]	○	[00-01]	00:OFF,01:ON
38	Pedal Voice 2	○	[00-01]	○	[00-01]	00:OFF,01:ON

Brilliance

Code	Switch	Transmit	Tx Range	Receive	Rx Range	Remarks
42	UK Voice 1	○	[00-06]	○	[00-06]	00: Brilliant; 06: Mellow
43	LK Voice 1	○	[00-06]	○	[00-06]	00: Brilliant; 06: Mellow
44	UK Voice 2	○	[00-06]	○	[00-06]	00: Brilliant; 06: Mellow
45	LK Voice 2	○	[00-06]	○	[00-06]	00: Brilliant; 06: Mellow
46	LEAD Voice	○	[00-06]	○	[00-06]	00: Brilliant; 06: Mellow
47	Pedal Voice 1	○	[00-06]	○	[00-06]	00: Brilliant; 06: Mellow
48	UK Voice 2	○	[00-06]	○	[00-06]	00: Brilliant; 06: Mellow

Sustain

Code	Switch	Transmit	Tx Range	Receive	Rx Range	Remarks
50	Upper Keyboard	○	[00-01]	○	[00-01]	00:OFF,01:ON
51	Lower Keyboard	○	[00-01]	○	[00-01]	00:OFF,01:ON
52	Pedalboard	○	[00-01]	○	[00-01]	00:OFF,01:ON

Keyboard Percussion

Code	Switch	Transmit	Tx Range	Receive	Rx Range	Remarks
5B	Lower Keyboard	○	[00-01]	○	[00-01]	00:OFF,01:ON
5C	Pedal Board	○	[00-01]	○	[00-01]	00:OFF,01:ON

Disable

Code	Switch	Transmit	Tx Range	Receive	Rx Range	Remarks
5F	Disable	○	[00-01]	○	[00-01]	00:OFF,01:ON

Tremolo

Code	Switch	Transmit	Tx Range	Receive	Rx Range	Remarks
60	Tremolo	○	[00-01]	○	[00-01]	00:SLOW,01:FAST

Rhythm Sequence

Code	Switch	Transmit	Tx Range	Receive	Rx Range	Remarks
61	Sequence 1	○	[00-01]	○	[00-01]	00:OFF,01:ON
62	Sequence 2	○	[00-01]	○	[00-01]	00:OFF,01:ON
63	Sequence 3	○	[00-01]	○	[00-01]	00:OFF,01:ON
64	Sequence 4	○	[00-01]	○	[00-01]	00:OFF,01:ON

*5 EL MIDI Parameters

Voice Section Parameters

Panel Voice Parameters

Address	Size	Data	Parameter	Data	Transmit	Tx Range	Receive	Rx Range	Remarks
00	00-04, 06, 07	00-0D	2	00-7F	Voice Assign Number H			[00-7F]	
				00-7F	Voice Assign Number L			[00-0F]	[00-7F]
00	00-04, 06, 07	10	1	00-0D	Voice Selector Number	x		[00-0D]	[00-0D]
00	00-04, 06, 07	11	1	00-7F	Volume		x	[00-7F]	[00-7F]
					00:MIN 7F:MAX				
00	00-04, 06, 07	12	1	00-7F	Reverb Send Level			[00-7F]	[00-7F]
					00:MIN 7F:MAX				
00	00-04, 06, 07	13	1	00-7F	Brilliance	x		[00] [15] [2B] [40] [55] [6B] [7F]	[00-0A] [0B-1F] [20-35] [36-4A] [4B-5F] [60-75] [76-7F]
					40:Center 7F:Mellow				
00	00-04, 06, 07	14	1	00-04	Feet			[00] [01] [02] [03] [04]	[00][05-7F] [01] [02] [03] [04]
					00:Preset 01:16Feet 02:8Fee 03:4Feet 04:2Feet				
00	00-04, 06, 07	15	1	00-7F	Pan			[0B] [1D] [2B] [40] [55] [63] [75]	[00-11] [12-25] [26-31] [32-4E] [4F-5A] [5B-6E] [6F-7F]
					40:Center 7F:Left				
00	00-04, 06, 07	16	1	00-7F	Initial Touch Sensitivity			[00-7F]	[00-7F]
					00:MIN 7F:MAX				
00	00-04, 06, 07	17	1	00-7F	After Touch Sensitivity			[00-7F]	[00-7F]
					00:MIN 7F:MAX				
00	00-04, 06, 07	19	1	00-01	User Vibrato			[00] [01]	[00] [01-7F]
					00:PRESET 01:USER				
00	00-04, 06, 07	1A	1	02-1A	Vibrato Delay			[02-1A]	[00-7F]
					00:Short 7F:Long				
00	00-04, 06, 07	1B	1	00-54	Vibrato Depth			[00-54]	[00-7F]
					00:MIN 7F:MAX				
00	00-04, 06, 07	1C	1	3C-6C	Vibrato Speed			[3C-6C]	[00-7F]
					00:Slow 7F:Fast				
00	00-04, 06, 07	1E	1	00-7F	Touch Vibrato On/Off			[00] [7F]	[00] [01-7F]
					00:OFF 01:ON				
00	04, 06, 07	1F	1	00-01	To Lower	x		[00] [01]	[00] [01-7F]
					00:OFF 01:ON				
00	04	20	1	00-02	Slide			[00] [01] [02]	[00] [01] [02]
					00:OFF 01:ON 02:KneeControl				
00	04	21	1	02-7F	Slide Speed			[02-7F]	[00-7F]
					02:Slow 7F:Fast				
00	04	22	1	00-24	Detune			[00-24]	[00-7F]
					00:Normal 24:TuneUP				
00	00-07 00, 01, 04, 06, 07	23	1	00-01	2nd Expression Pedal			[00] [01]	[00] [01-7F]
					00:OFF 01:ON				
00	00-04	24	1	00-01	Glide			[00] [01]	[00] [01-7F]
					00:OFF 01:ON				

Flute Voice Parameters (EL-700 only)

Address		Size	Data	Parameter	Content	Transmit	Tx Range	Receive	Rx Range	Remarks
01	00-01 00	1	00-7F	FLUTE 16Feet	00:MIN 7F:MAX	○	[00-7F]	○	[00-7F]	
01	00-01 01	1	00-7F	FLUTE 8Feet	00:MIN 7F:MAX	○	[00-7F]	○	[00-7F]	
01	00-01 02	1	00-7F	FLUTE 5-1/3Feet	00:MIN 7F:MAX	○	[00-7F]	○	[00-7F]	
01	00-01 03	1	00-7F	FLUTE 4Feet	00:MIN 7F:MAX	○	[00-7F]	○	[00-7F]	
01	00-01 04	1	00-7F	FLUTE 2-2/3Feet	00:MIN 7F:MAX	○	[00-7F]	○	[00-7F]	
01	00-01 05	1	00-7F	FLUTE 2Feet	00:MIN 7F:MAX	○	[00-7F]	○	[00-7F]	
01	00-01 06	1	00-7F	FLUTE 1-3/5Feet	00:MIN 7F:MAX	○	[00-7F]	○	[00-7F]	
01	00-01 08	1	00-7F	FLUTE 1Feet	00:MIN 7F:MAX	○	[00-7F]	○	[00-7F]	
01	00-01 09	1	00-7F	FLUTE Response	00:Slow 06:Fast	○	[43-7F]	○	[00-7F]	
01	00-01 0A	1	00-7F	ATTACK 4Feet	00:MIN 7F:MAX	○	[00-7F]	○	[00-7F]	
01	00-01 0B	1	00-7F	ATTACK 2-2/3Feet	00:MIN 7F:MAX	○	[00-7F]	○	[00-7F]	
01	00-01 0C	1	00-7F	ATTACK 2Feet	00:MIN 7F:MAX	○	[00-7F]	○	[00-7F]	
01	00-01 0D	1	00-7F	ATTACK Length	00:Short 06:Long	○	[30-48]	○	[00-7F]	
01	00-01 0E	1	00-7F	Click	00:MIN 7F:MAX	○	[00-7F]	○	[00-7F]	
01	00-01 11	1	00-7F	Flute Coupler On/Off	00:OFF 01:ON	×	[00] [01]	○	[00] [01-7F]	
01	00-01 12	1	00-7F	Volume	00:MIN 7F:MAX	○	[00-7F]	○	[00-7F]	
01	00-01 13	1	00-7F	Reverb Send Level	00:MIN 7F:MAX	○	[00-7F]	○	[00-7F]	
01	00-01 20	1	00-07 40-47	Parameter Load	00-07:PresetParameter 40-47:UserParameter	○	[00-07] [40-47]	○	[00-07] [40-47]	
01	00-01 21	1	40-47	Parameter Save	40-47:UserParameter	○	[40-47]	○	[40-47]	

Effect Parameters (Voice Sections)

Address		Size	Data	Parameter	Content	Transmit	Tx Range	Receive	Rx Range	Remarks
00-01	00-04, 06, 07	3F	1	00-05	Effect Select	○	[00] [01] [02] [03] [04] [05] [06]	○	[00][07-7F] [01] [02] [03] [04] [05] [06]	
00-01	00-04, 06, 07	40-42	1	00-7F	Reverb	×	[00-7F]	○	[00-7F]	
00-01	00-04, 06, 07	48-4A	1	00-7F	Tremolo	×	[00-7F]	○	[00-7F]	
00-01	00-04, 06, 07	50	1	00-7F	Symphonic	○	[00-7F]	○	[00-7F]	
00-01	00-04, 06, 07	58-5B	1,2	00-7F	Delay	○	[00-7F]	○	[00-7F]	
00-01	00-04, 06, 07	60-62	1	00-7F	Flanger	○	[00-7F]	○	[00-7F]	
00-01	00-04, 06, 07	68-69	1	00-7F	Distortion	○	[00-7F]	○	[00-7F]	

Keyboard Parameters

Sustain Parameters

Address		Size	Data	Parameter	Content	Transmit	Tx Range	Receive	Rx Range	Remarks
02	00-02	00	1	00-01	Sustain On/Off	00:OFF 01:ON	×	[00] [01]	○ [00-7F]	
02	00-02	01	1	00-0C	Length	00:Short 0C:Long	○	[15-3D]	○ [00-7F]	

Keyboard Percussion Parameters

Address		Size	Data	Parameter	Content	Transmit	Tx Range	Receive	Rx Range	Remarks
02	01-02	10	1	00-01	Keyboard Percussion	00:OFF 01:ON	×	[00] [01]	○ [00-7F]	
02	01-02	11	1	00-08	Modes	00:Preset 01-08:UserAssign1-8	○	[00] [01-08]	○ [00-7F]	

Effect Parameters (Keyboard)

Address		Size	Data	Parameter	Content	Transmit	Tx Range	Receive	Rx Range	Remarks
02	00-02	40-42	1		Reverb		×	[00-7F]	○ [00-7F]	
02	00-02	48-4A	1		Tremolo		×	[00-7F]	○ [00-7F]	
02	00-02	50	1		Symphonic		×	[00-7F]	○ [00-7F]	
02	00-02	58-5B	1,2		Delay		×	[00-7F]	○ [00-7F]	
02	00-02	60-62	1		Flanger		×	[00-7F]	○ [00-7F]	
02	00-02	68-69	1		Distortion		×	[00-7F]	○ [00-7F]	

Rhythm

Rhythm Parameters

Address		Size	Data	Parameter	Content	Transmit	Tx Range	Receive	Rx Range	Remarks
03	00	00-0B	1	00-65 67-98	Pattern Assign Number	Pattern Numbers	○	[00-62]	○ [00-62]	
03	00	10	1	00-0B	Pattern Select Number	Selector Switch Numbers	×	[00-0B]	○ [00-0B]	
03	00	11	1	00-7F	Volume	00:MIN 7F:MAX	×	[00-7F]	○ [00-7F]	
03	00	12	1	00-7F	Reverb Send Level	00:MIN 7F:MAX	○	[00-7F]	○ [00-7F]	
03	00	14	1	00-01	Auto Variation	00:OFF 01:ON	○	[00] [01]	○ [00-7F]	
03	00	15	1	00-7F	Rhythm Balance	00:Cymbal 40:Center 7F:Drums	○	[00-7F]	○ [00-7F]	
03	00	16	1	00-01	2nd Expression Tempo Control	00:OFF 01:ON	○	[00] [01]	○ [00-7F]	EL-500 not transmit
03	00	17	1	00-03	Footswitch Rhythm Mode	00:OFF 01:RhythmStop 02:Ending 03:FillIn	○	[00] [01] [02] [03]	○ [00-7F] [01] [02] [03]	

Rhythm Sequence Parameters

Address		Size	Data	Parameter	Content	Transmit	Tx Range	Receive	Rx Range	Remarks
03	01	00-03	1	00-01	Rhythm Sequence	00:OFF 01:ON	×	[00] [01]	○ [00-7F]	

Accompaniment Parameters

Address			Size	Data	Parameter	Content	Transmit	Tx Range	Receive	Rx Range	Remarks
03	02	10	1	00-03	Pattern Selector Number	00:Type1 01:Type2 02:Type3 03:Type4	○	[00] [01] [02] [03]	○	[00] [01] [02] [03]	
03	02	11	1	00-01	Volume Mute	00:OFF 01:MUTE	○	[00] [01]	○	[00] [01-7F]	
03	02	12	1	00-7F	Volume	00:MIN 7F:MAX	○	[00-7F]	○	[00-7F]	
03	02	13	1	00-7F	Reverb Send Level	00:MIN 7F:MAX	○	[00-7F]	○	[00-7F]	

A.B.C. Parameters

Address			Size	Data	Parameter	Content	Transmit	Tx Range	Receive	Rx Range	Remarks
03	03	00	1	00-03	A.B.C. Mode	00:OFF 01:SingleFinger 02:Fingerd 03:CustomABC	○	[00] [01] [02] [03]	○	[00][04-7F] [01] [02] [03]	
03	03	01	1	00-01	Lower Memory	00:OFF 01:ON	○	[00] [01]	○	[00] [01-7F]	
03	03	02	1	00-01	Pedal Memory	00:OFF 01:ON	○	[00] [01]	○	[00] [01-7F]	

M.O.C. Parameters

Address			Size	Data	Parameter	Content	Transmit	Tx Range	Receive	Rx Range	Remarks
03	04	00	1	00-03	M.O.C. Mode	00:OFF 01:Close2Note 02:Close3Note 03:PassBOpen	○	[00] [01] [02] [03]	○	[00][04-7F] [01] [02] [03]	
03	04	01	1	00-01	M.O.C. Knee Control	00:OFF 01:ON	○	[00] [01]	○	[00] [01-7F]	

Overall System Parameters

Address		Size	Data	Parameter	Content	Transmit	Tx Range	Receive	Rx Range	Remarks
04	00	00	1	00-01	Disable	00:OFF 01:ON	×	○	[00] [01-7F]	
04	00	01	1	00-01	Flute Coupler Attack Mode	00:EachKey 01:FirstNewKey	○	○	[00] [01-7F]	EL-500 not transmit
04	00	02	1	3A-46	Transpose	3A:KeyDown 40:Normal 46:KeyUp	○	○	[3A] [40] [46]	
04	00	03	1	00-0B	2nd Expression Range	01:100 ¢ 0C:1200 ¢	○	○	[01-0C]	EL-500 not transmit
04	00	04	1	00-03	Footswitch Mode	00:OFF 01:Rhythm 02:Glide 03:Tremolo	○	○	[00][04-7F] [01] [02] [03]	
04	00	05	1	3C-4F	Pitch	3C:PitchDown 40:Normal 4F:PitchUp	○	○	[3C-4F]	
04	00	06	1	00-04	Glide Speed	01:Slow 05:Fast	○	○	[04-1C]	
04	00	07	1	34-4C	Manual Balance	34:Upper 40:Center 4C:Lower	○	○	[34-4C]	
04	00	09	1	00-01	L.I.T.	00:Mode1 01:Mode2	○	○	[00] [01]	
04	00	0A	1	00-01	Expression INT/EXT	00:Internal 01:External	×	○	[00][02-7F] [01]	

Effect Parameters (Overall)

Address		Size	Data	Parameter	Content	Transmit	Tx Range	Receive	Rx Range	Remarks
04	00	40-42	1	Reverb		○	[00-7F]	○	[00-7F]	
04	00	48-4A	1	Tremolo		○	[00-7F]	○	[00-7F]	
04	00	50	1	Symphonic		×	[00-7F]	○	[00-7F]	
04	00	58-5B	1,2	Delay		×	[00-7F]	○	[00-7F]	
04	00	60-62	1	Flanger		×	[00-7F]	○	[00-7F]	
04	00	68-69	1	Distortion		×	[00-7F]	○	[00-7F]	

*6 External MDR

nn	Command	Transmit	Receive
01	Play Start	×	○
02	Play Stop	×	○
03	Record Start	×	○
04	Record Stop	×	○
09	Rhythm Pointer Reset	×	○

MIDI Implementation Chart

YAMAHA [Electone-EL mode] / Model: EL-700/500

Date:14. Jan.1999

Version: 1.00

Function		Transmit	Receive	Remarks
Basic Channel	Default Changed	1, 2, 3, 16 *1 1-16	1-3, 5-16 *2 4	
Mode	Default Messages Altered	Mode 3 × *****	Mode 3 × ×	
Note Number	True Voice	36-96 *3 *****	0-127 *4	
Velocity	Note ON Note OFF	○ 9nH, v=1-127 ○ 9nH, v=0	○ 9nH, v=1-127 ○ 9nH, v=0, 8nH	Transmit with EL-500: fixed to 80.
After Touch	Key's Ch's	× ○	× ○	PK after touch with EL-500: not transmit.
Pitch Bend		×	○ *6	
Control Change	0, 32 1, 5, 7, 10 4 6, 38 11 96, 97 64-67 71-74 84, 91, 93, 94 98-99, 100-101 120, 121	× × ○ *7 (EL-500 not transmit) × ○ *7 × × × × × × × ×	○ *6 ○ *6 ○ *7 ○ *6 ○ *6, 7 ○ *6 ○ *6 ○ *6 ○ *6 ○ *6 ○ *6 ○ *6	Bank Select 2nd Expression Pedal Data Entry Expression Pedal Data Entry SW Sound Controller NRPN, RPN
Program Change	Range	○ *9 *****	○ *10	
System Exclusive		○	○	
System Common	Song Position Song Select Tune	× × ×	× × ×	
System Real Time	Clock Commands	○ ○	○ *8 ○	(FAH, FCH)
Aux Messages	Local ON/OFF All Notes OFF Active Sense Reset	× × ○ ×	× ○ (123-127) *10 ○ ×	
Notes		*1 Ch 1: UK; Ch 2: LK; Ch 3: PK; Ch 16: Control *2 Ch 1: UK; Ch 2: LK; Ch 3: PK; Ch 4: LEAD 1; Chs 5 - 14: XG; Ch 15: Keyboard *3 UK: 48 - 96; LK: 36 - 84; PK: 36 - 55 *4 UK, LK, PK, LEAD 1: 36 - 96; XG: 0 - 127; Keyboard Percussion: 3 - 127 *5 UK: UK Horizontal Touch; LK: LK Horizontal Touch *6 XG only *7 Control only *8 External Mode only *9 Control: 0 - 15, 112 - 116 *10 UK, LK, PK, Control: 0 - 15, 112 - 116; XG: 0 - 127		

Mode 1 : OMNI ON, POLY
Mode 3 : OMNI OFF, POLY

Mode 2 : OMNI ON, MONO
Mode 4 : OMNI OFF, MONO

○ : YES
× : NO

Function		Transmit *12	Receive	Remarks
Basic Channel	Default Changed	1, 2, 3, 16 1-16	1-16 1-16	
Mode	Default Messages Altered	Mode3 X *****	Mode 3 X X	
Note Number	True Voice	36-96 *****	0-127	
Velocity	Note ON Note OFF	○ 9nH, v=1-127 ○ 9nH, v=0	○ 9nH, v=1-127 ○ 9nH, v=0, 8nH	Transmit with EL-500: fixed to 80.
After Touch	Key's Ch's	X ○	X ○	
Pitch Bend		X	○	
Control Change	0, 32 1, 5, 7, 10 4 6, 38 11 96, 97 64-67 71-74 84, 91, 93, 94 98-99, 100-101 120, 121	X X ○ X ○ X X X X X X X	○ ○ X ○ ○ ○ ○ ○ ○ ○ ○ ○	Bank Select 2nd Expression Pedal Data Entry Expression Pedal Data Entry SW Sound Controller NRPN, RPN
Program Change	Range	○ 0-15, 112-116 *****	○	
System Exclusive		○	○	
System Common	Song Position Song Select Tune	X X X	X X X	
System Real Time	Clock Commands	○ ○	X X	
Aux Messages	Local ON/OFF All Notes OFF Active Sense Reset	X X ○ X	X ○ (123-127) ○ X	
Notes		*11 The same as the one in the EL Mode		

Mode 1 : OMNI ON, POLY
Mode 3 : OMNI OFF, POLY

Mode 2 : OMNI ON, MONO
Mode 4 : OMNI OFF, MONO

○ : YES
X : NO

Troubleshooting

Please note that the appearance of any of following phenomena does not indicate a mechanical failure of the Electone.

Problem	Possible Cause and Solution
GENERAL OPERATION	
Some of the LEDs in the DISPLAY SELECT section do not light.	The LEDs of on/off buttons (UPPER/LOWER FLUTE VOICES, VOICE EDIT, RHYTHM PROGRAM, and TREMOLO [FAST]) are lit when those functions are turned on. The LEDs of other function's buttons momentarily flash when the functions are selected.
A cracking noise is sometimes heard.	Noise may be produced when either an electrical appliance is turned on or off, or an electric power tool (such as drill) is used in the proximity of the Electone. If this occurs, plug the Electone into an electrical outlet located as far as possible from the device that seems to be the source of the problem.
Interference from radio, TV, or other sources occurs.	This is caused by the proximity of a high-power broadcasting station, an amateur ham radio setup or a mobile phone.
The sound of the Electone causes surrounding objects to resonate.	Because the Electone is capable of producing powerful bass sounds, resonance may be caused in surrounding objects, such as cabinets or glass windows. To avoid this, relocate the objects or lower the Electone's volume.
The Electone panel does not function normally or the content of the memorized data has changed.	This happens very rarely. Occasionally, power surges and spikes due to electrical storms or other reasons may cause the Electone to malfunction and/or alter the contents of memorized data. If this happens, perform the Power On Reset operation to reset the Electone. (page 83)
The sound is too small even when the volume is set to its maximum.	<ul style="list-style-type: none"> The Master Volume may be set around the minimum position. Turn it clockwise. The Expression Pedal may not be pressed down. Press it down with your toe.
Pressing a certain panel button doesn't open its related LCD display.	The HOLD button may be engaged. Press the HOLD button to cancel the Hold function and press the button again.
VOICES/RHYTHMS	
When selecting a dotted button voice or rhythm, the voice or rhythm title at the top of the LCD does not match the voices or rhythms.	The currently assigned voice or rhythm is displayed at the top of the LCD, and remains until another voice or rhythm has been selected.
When too many keys are pressed, not all of the notes sound.	Total polyphonic capacity (notes sounding for both Upper and Lower Keyboards) is 12 notes. Polyphonic capacity is 12 for both the Upper and Lower Flute Voices, and 6 each for the Upper and Lower Attack sound (EL-700's Flute Voice).
When playing a Pedal voice from the Lower keyboard (using the To Lower function), pressing the Lower keyboard's Sustain button does not turn on Sustain.	Even though the Pedal voice is being played from the Lower keyboard, it is still a Pedal voice; turn the Sustain on with the Pedal Sustain button.
The sound is too soft, despite the volume being set to the maximum.	Check all of the volume controls, making sure that they are set to suitable levels: the panel Volume controls for each voice section, the Master Volume dial, and the Expression Pedal. Also check the Upper/Lower Balance control on the Voice Display. (page 28)
Switching voices causes the volume to change, despite their having identical volume settings.	The volume of certain voices may seem lower than that of others. Adjust the balance of the sound with the Volume control within the appropriate Voice Condition display.
When keys on the Lower keyboard or Pedalboard are pressed, the sounds of percussion instruments are also heard.	The keyboard Percussion function has been turned on. When not using the function, be sure to turn it off. (page 68)

Problem	Possible Cause and Solution
VOICES/RHYTHMS	
Only one sound is heard when two notes of the Lead or Pedal voices are simultaneously played.	For practical performance reasons, the Electone has been designed so that one note of the Lead or Pedal voices can be played at a time. If several keys are pressed at once, only the highest note will be sounded (highest-note priority).
The Pedal voices do not sound, even though the volume is properly set.	<ul style="list-style-type: none"> • The Single Finger or Fingered Chord mode of Auto Bass Chord is on. Turn off the mode in the display. (page 65) • TO LOWER buttons in the Pedal voice sections are turned on. Turn the function off.
The pitch may be felt high on the Pedalboard and low in the higher registers of the Lower and Upper keyboards.	This may occur when you compare the Electone's sounds with the one of pianos. Because of the difference of the harmonics structure, the tuning system of the Electone is different from the piano's in the higher and lower ranges.
Some of the voices may contain cracking and/or noisy sounds.	You may find these mainly in the wind instrument voices. These are purposely added effects to the voices to reproduce the characteristics of the wind instruments such as the pipe vibrations, breath noises and squeakings.
Even though a Dotted button's rhythm has been selected and started, the pattern does not sound.	Since the Dotted buttons contain User rhythms, no rhythm will sound if a pattern has not been saved to the selected Dotted button.
EFFECTS	
The Touch Tone function does not operate.	Adjust the Touch Tone settings in the Voice Condition display.
The Tremolo effect cannot be heard, even when the TREMOLO (FAST) button in the DISPLAY SELECT section is on.	Tremolo must be selected first in the Voice Condition display (for panel voices), or in the Flute Voices Volume page (for Flute Voices [EL-700]).
The Reverb effect does not operate, even when Reverb parameters for the selected voice sections are increased.	Increase the Reverb on the panel Reverb controls, or increase the Reverb Depth in Reverb Page 1.
ACCOMPANIMENT	
The pitch in the Single Finger mode does not change, even when pressing different keys of the keyboard.	Single Finger mode will only produce notes when played within a fixed octave interval on the Lower keyboard. If notes with the same letter name are pressed outside of that range, the chords that are sounded will share the same pitch.
While an intro./Ending pattern is automatically playing, the Lower keyboard does not produce any sound, even when the keys are played.	Since the Accompaniment chords play automatically one after another, the Lower keyboard is designed not to produce any sound during the playback of an Intro./Ending pattern.
The Accompaniment cannot be heard even when an appropriate Accompaniment type is selected and the rhythm has been started.	The Accompaniment volume is set to 0 as the default. Be sure to raise the Accompaniment volume on the rhythm condition page.
The harmony notes of the Melody On Chord function cannot be heard.	The Upper keyboard has been set to sound only Lead voices. Increase the volume of the Upper Keyboard voices.
REGISTRATION MEMORY	
Certain functions have not been memorized to Registration Memory.	Transposition and Pitch control data, among others, cannot be memorized (except as song data). (page 77)

Problem	Possible Cause and Solution
VOICE EDITING	
During voice editing, the specified voice isn't heard, even when the keyboard is played.	The current settings keep the voice from sounding. Make sure that the volume of the voice is set to a suitable level, and adjust the various parameters in the Voice Edit display until the voice can be heard.
Changing the Envelope Generator of the Carrier (FM Operator) causes a timing gap in timbre changes.	When you make a change in the Envelope Generator of the Carrier (how the volume changes over time), do the similar change in the Envelope Generator of the Modulator (how the timbre changes over time).
RHYTHM PROGRAM	
During use of the Rhythm Pattern Program, no sound is produced even when you play a certain percussion sound.	If percussion sounds have been recorded to all 16 rhythm tracks, no subsequently selected instruments can be heard or recorded. If necessary, erase one of the tracks and play the sound.
MUSIC DISK RECORDER	
Recording or playback cannot be performed.	<ul style="list-style-type: none"> • Problems in recording or playback may be caused by improper operation of the M.D.R. Refer to the LED Display Messages chart on page 106. • The PLAY or RECORD section buttons for selecting parts may be turned off. Turn on the appropriate PLAY or RECORD buttons.
A total of 40 songs cannot be recorded.	If some song numbers contain a large amount of recorded data, the disk may not have enough available memory left to record the normal maximum of 40 songs.
Recording is stopped before the performance is finished, or the Song Copy function cannot be executed.	The amount of recorded data on the disk is close to the maximum limit. Either use another disk or delete the data of any unnecessary song number.
The rhythm does not start at the beginning of a recording, or stops in the middle of the performance.	The M.D.R. is designed so that the rhythm cannot be started at the very beginning of a recording. If you wish to use the rhythm, start it after the available memory display appears on the M.D.R. display.
The notes of the recording are "stuck" and sound continuously.	During playback, you removed the disk by pressing the EJECT button. Whenever you wish to stop playback, always press the STOP button.

EL-700/500 Specifications

KEYBOARD		Upper: 49 keys (C – C), Lower: 49 keys (C – C), Pedal: 20 keys (C – G)
Touch Tone	Initial Touch	Upper, Lead, Lower, Pedal *
	After Touch	Upper, Lead, Lower, Pedal *
VOICE	Tone Generation	New AWM & FM
	Upper Keyboard Voice 1, 2 Lower Keyboard Voice 1, 2	Strings 1, 2, 3, 4, 5, 6, 7, Pizz. Strings, Tremolo Strings, Synth. Strings 1, 2, 3; Brass 1, 2, 3, 4, 5, Synth. Brass 1, 2, 3; Clarinet 1, 2, Bass Clarinet, Synth. Clarinet 1, 2; Saxophone 1, 2, Soprano Sax., Sax. Ensemble 1, 2, Synth. Sax, Synth. Lead 1, 2, 3, 4, 5; Chorus 1, 2, 3, 4, 5, Vocal; Organ 1, 2, 3, 4, Jazz Organ 1, 2, 3, 4, Pop Organ 1, 2, Theatre Organ 1, 2, Accordion, Bandoneon; Piano 1, 2, Honky Tonk, Elec. Piano 1, 2, 3, Harpsichord, Clavi., Clavichord; Guitar 1, 2, 3, 12 String Guitar, Banjo, Mandolin, Sitar, Shamisen, Elec. Guitar 1, 2, Muted Guitar, Distortion Guitar, Steel Guitar, Harp, Koto, Taisho Koto; Vibraphone, Glockenspiel, Celesta, Music Box, Marimba, Xylophone, Chime, Synth. Chime, Steel Drum; Cosmic 1, 2, 3, 4, 5, 6, 7, 8, 9, 10, 11, 12, 13, 14, 15, 16; Tutti 1, 2, 3, 4, 5, 6, 7; [Upper] Harmonica 1, 2; [Lower] Horn 1, 2, 3, 4, Muted Horn; User 1-16; 2 Dotted Buttons; [Upper] 115 Voices; [Lower] 118 Voices; Volume Fine; Brilliance **
	Lead Voice	Violin 1, 2, 3, 4, 5, Pizz. Violin, Cello, Kokyu; Flute 1, 2, Piccolo, Recorder, Yokobue, Ocarina, Pan Flute, Shakuhachi, Whistle; Oboe 1, 2, English Horn, Bassoon 1, 2; Trumpet 1, 2, 3, 4, 5, 6, Muted Trumpet, Trombone 1, 2, Muted Trombone, Flugel Horn, Euphonium; User 1-16; To Lower; Dotted Button; 34 Voices; Volume Fine; Brilliance **
	Pedalboard Voice 1, 2	Contrabass 1, 2, 3, Pizz. Bass, Upright Bass; Elec. Bass 1, 2, 3, 4, Synth. Bass 1, 2, 3; Organ Bass 1, 2, 3, 4; Tuba, Timpani, Timpani Roll; User 1-16; To Lower; Dotted Button; 19 Voices; Volume Fine; Brilliance **
	Voice Display	Upper 1,2; Lower 1,2; Lead; Pedal 1,2; Manual Balance
Upper Flute Voice/Lower Flute Voice(EL-700 only)		Flute Voices (16', 8', 51/3', 4', 22/3', 2', 13/5', 1'); Attack (4', 22/3', 2'); Length; Mode: Each, First); Click; Response; Tremolo On/Off; Reverb; Volume; 8 Presets; 8 User Voices; On/Off Control: Upper, Lower
VOICE EDIT		On/Off; Operator 1, 2, 3, 4, 5, 6, 7, 8;(Output Level, Attack Rate, Decay 1 Rate, Decay 1 Level, Decay 2 Rate, Release Rate); AWM: (Output Level, Attack Rate, Decay Rate, Release Rate, Low, High); Operator Selectors; Operator On/Off Buttons; Save: User: 1 – 16; (From) Voice Disk; Voice Name
EFFECT/CONDITION	Digital Reverb	3 Types: Room, Hall, Church; Length; Depth; Volume: Upper/Lower 1, 2, Flute Voice, Lead, Pedal 1, 2, Accompaniment, Percussion; Set: Length, Depth
	Sustain	Upper (Knee), Lower (Knee), Pedal: Length
	Brilliance	Upper 1, 2, Lower 1, 2, Lead, Pedal1, 2: Control: Brilliant/Mellow (EL-700 only)
	Tremolo/Chorus	Upper 1, 2, Lower 1, 2, Lead, Pedal1, 2, Flute Voice (EL-700 only); Tremolo (Fast): Speed; Chorus: Slow, Stop
	Symphonic/Celeste	Upper 1, 2, Lower 1, 2, Lead, Pedal1, 2; Mode: Symphonic/Celeste
	Vibrato	Upper 1, 2, Lower 1, 2, Lead, Pedal1, 2: Preset/User (Delay, Depth, Speed); Touch Vibrato
	Delay	Upper 1, 2, Lower 1, 2, Lead, Pedal1, 2; Control: Time, Feedback, Balance; Mode: Mono, Stereo 1, 2, 3
	Flanger	Upper 1, 2, Lower 1, 2, Lead, Pedal1, 2; Control: Speed, Feedback, Depth
	Distortion	Upper 1, 2, Lower 1, 2, Lead, Pedal1, 2; Control: Level, Hi-pass
	Glide	Upper 1, 2, Lower 1, 2, Lead; Control: Time
	Lead Slide	On/Knee/Off; Control: Time
	Lead Tune	Tune Control
	Panning	Upper 1, 2, Lower 1, 2, Lead, Pedal1, 2; (7 positions)
	Feet	Upper 1, 2, Lower 1, 2, Lead, Pedal1, 2; Preset 2' (Pedal Voices only)/4'/8'/16'
	RHYTHM	Rhythms
Variations		Fill-In; Intro. Ending; Lead In; Auto Variation: On/Off
Others		Start; Synchro Start; Tempo; Bar/Beat LED; Condition: Reverb, Balance, Volume; Instrument: Tune, Pan, Reverb, Volume; Assign: Normal, Extend(ed), Copy Preset

* Pedal Touch Tone on EL-500: not accessible on the panel (Voice Condition page) but can be controlled via MDR or an external MIDI device.

** Brilliance on EL-500: not accessible on the panel but can be controlled with the Voice Condition page.

RHYTHM PROGRAM	Pattern Program	On/Off; Step Write/Real Time Write; Beat (4/4, 3/4, 2/4); Quantize ( Off); Metronome (On/Off); Assign (Normal/Extend); Edit: Instruments 1-16 (Change, Clear; Cursor); Accent Level 0-8; 120 Instruments; Accompaniment Select; Lower Rhythmic (Clear, Change, 16 Accompaniment Voices); Save: User 1-8 (A-D, Fill-In); (From) Pattern Disk; Pattern Name; Remaining Memory Display
	Rhythm Sequence	On/Off; Sequence 1-4; 120 Positions (Bar); Cursor Controls; Data: Preset/User (Set, Insert, Delete, Clear)
KEYBOARD PERCUSSION		Lower, Pedal On/Off; Lower Preset, Pedal Preset, User 1- 8; Copy: LK Preset, PK Preset, User; Assign: 120 Instruments, Clear
ACCOMPANIMENT	Auto Bass Chord	Mode: Off; Single Finger; Fingered Chord; Custom A.B.C.; Memory: Lower, Pedal
	Accompaniments	Type 1, 2, 3, 4, All Off
MELODY ON CHORD		Mode: Off, 1, 2, 3; Knee: On/Off
BASIC REGISTRATION		1 – 5
REGISTRATION MEMORY		M./To Disk, EL-700:1-16, EL-500:1-8; Disable Button; Mode: Off; Shift; Jump; User (80 Positions); Cursor Controls: Data: Set, Insert, Delete, Clear; Shift End: Stop, Top, Next Song)
MUSIC DISK RECORDER		Play/Record: Upper, Lower, Pedal, Lead, Keyboard Percussion, Control; Pause, Stop, Fast Forward/Reverse, Song Select, Shift, Custom Play, Tempo; Format, Read & Auto Increment, Song Repeat; Song Delete; Song Copy: From/To; Disk Copy, Punch in Recording, XG Song Playback, XG Easy Converter, Song Name, Voice Disk, Pattern Disk, Remaining Memory; LED Display; Eject
FOOT SWITCH	Left	Mode: Off; Rhythm (Stop, Ending, Fill-In); Glide (Upper/Lower/Lead; Time); Tremolo (On/Off)
	Right	Regist. Shift Mode: Off, Shift, Jump, User
KNEE LEVER		On/Off; Sustain (Upper, Lower); M.O.C.; Lead Slide; Solo/Upper Mode
2ND EXP. PEDAL (EL-700 only)		Pitch Bend (On/Off: Upper/LeadPedal 1, 2; Range 1 -12); Tempo (Range 1 -12)
TRANPOSE/PITCH		Transpose: -6 - +6; Pitch: 438.8Hz - 444.5Hz
LCD DISPLAY		320 x 80 Full Dot
OTHER CONTROLS		Power On/Off; Exp. Pedal (Right/Left Footswitches); 2nd ExpressionPedal (EL-700 only); Pitch Control; Transpose; Master Volume; Display Select; Data Controls; Page; Coarse; Hold; LCD Contrast; MIDI (Output: Upper, Lower, Pedal; Int./Ext.: Lead, Sync., Exp.); Lead Initial Touch
OTHER FITTINGS		Registration Menu Disk; 3.5" Floppy Disk; Matching Bench; Keyboard Cover/Music Stand; Headphone Jack; Rhythm In (Phone; R/L); Aux Out (Phone; R/L)(EL-700 only); Aux In/Out (RCA; R/L); Mic In (EL-700 only); Mic. Volume (EL-700 only); MIDI IN/OUT; To Host; Host Select
OPTIONAL ACCESSORIES		Voice Disk; Pattern Disk; HPE-170 Headphones; 3.5" Floppy Disks
SOUND SYSTEM	Power Amplifiers	216W (Stereo) (EL-700) / 110W (Stereo) (EL-500)
	Speakers	20cm x 2; 18cm x 2; 2.5cm x 2; Monitor 6.6cm x 2 (EL-700) 20cm x 2; 5cm x 2; Monitor 6.6cm x 2 (EL-500)
DIMENSIONS Width x Depth x Height		114.9cm x 55.6cm x 98.0cm *With Keyboard Cover Closed Bench: 79.6cm x 33.6cm x 58.0cm (EL-700) Bench: 66.5cm x 29.7cm x 58.0cm (EL-500)
WEIGHT		93kg, Bench: 10kg (EL-700) 83kg, Bench: 7.5kg (EL-500)

Specifications and description in this Owner's Manual are information purposes only. Yamaha Corp. reserves the right to change or modify products or specifications at any time without prior notice. As specifications, equipment or options may not be the same in every locale, please check with Yamaha dealer.

Index

A

A.B.C.	65
A.B.C./M.O.C.	66, 76
ACC. (ACCOMPANIMENT)	67
ACCENT(LOWER RHYTHMIC)	136
ACCENT(RHYTHM PROGRAM)	131
ACC. (RHYTHM PROGRAM)	134
AFTER	42
ALG (ALGORITHM)	108, 116
AR (AWM)	117
AR (FM)	118
ASSIGN (INSTRUMENT)	60
ASSIGN (KEYBOARD PERCUSSION)	71
ASSIGN (RHYTHM PROGRAM)	128
ATTACK	38
AUTO VARI.	59
AUX. IN/OUT	157
AWM	117

B

BAL. (DELAY)	47
BAL. (PERCUSSION)	59
BAR/BEAT	58
BASIC REGIST.	13
BEAT	128
BRIL. (BRILLIANCE)	44

C

CARRIER (VOICE EDIT)	116
CELESTE	46
CHANGE (RHYTHM PROGRAM)	129
Change Name (SONG NAME)	89
CHANGE VOICE (LOWER RHYTHMIC)	135
CHOR. (CHORUS)	46, 55
CHURCH (REVERB)	49
CLEAR (KEYBOARD PERCUSSION)	71
CLEAR (LOWER RHYTHMIC)	135
CLEAR (REGIST SHIFT)	82
CLEAR (RHYTHM PROGRAM)	130, 133
CLEAR (SEQUENCE)	144
CLICK	38
COARSE	23
COMBINATION	37
CONTRAST	23
COPY/LK PRESET (KEYBOARD PERCUSSION)	74
COPY/PK PRESET (KEYBOARD PERCUSSION)	74
COPY/PRESET (INSTRUMENT)	60
COPY PROTECT	105
COPY/USER (KEYBOARD PERCUSSION)	75
Custom A.B.C.	65
CUSTOM PLAY	87, 99

D

D. (Disable)	78, 83
DATA CONTROL	21
DATA (REGIST SHIFT)	81
DATA (SEQUENCE)	144
DELAY	44, 46
DELAY (VIBRATO)	45
DEL. (REGIST SHIFT)	82
DEL. (SEQUENCE)	144
DEPTH (FLANGER)	48
DEPTH (REVERB)	49
DEPTH (VIBRATO)	45
Disk Copy (MDR)	103
DISPLAY SELECT	22
DIST. (DISTORTION)	48
Dotted Button (Voice)	29
Dotted Button (Rhythm)	61
DR(AWM)	117
D1L (FM)	118
D1R (FM)	118
D2R (FM)	118

E

EACH (FLUTE VOICE)	38
EDIT (REGIST SHIFT)	81
EDIT (RHYTHM PROGRAM)	129, 133
EDIT (VOICE EDIT)	107
EFFECT	43
EFFECT SET	45
ENDING	57
Envelope Parameter (VOICE EDIT)	119
EXP. (EXPRESSION)	13, 152
EXP./PITCH/MIDI	152, 155, 156
EXTEND(ED) Set	60, 126, 128

F

Fast Forward/Reverse	99
FB. (DELAY)	47
FB. (FLANGER)	48
Feed Back (VOICE EDIT)	119
FEET	43
FILL IN	58
Fingered Chord	65
FIRST (FLUTE VOICE)	38
FLANG. (FLANGER)	44, 47
FM	118
FOOTAGE	37
FOOT SW	148
FOOT SWITCH-LEFT	148
FOOT SWITCH-RIGHT	79
FORMAT	86

G

GLIDE CONTROL	149
---------------	-----

H

HALL (REVERB)	49
HEADPHONES	157
HIGH (AWM)	117
HOLD	23
HOST SELECT	157

I

INITIAL	42
INS. (REGIST SHIFT)	82
INS. (SEQUENCE)	144
INST. (KEYBOARD PERCUSSION)	71
INSTRUMENT (RHYTHM)	60
INSTRUMENT (RHYTHM PROGRAM)	129
INT./EXT.	156
INTRO. ENDING	57

J

JUMP (REGIST SHIFT)	80
---------------------	----

K

KEYBOARD PERCUSSION	68
KNEE	150

L

LCD Display	20
Lead In	57
LEAD VOICE	26
LED Messages (MDR)	106
LENG. (FLUTE VOICE)	38
LENG. (REVERB)	49
LENGTH (SUSTAIN)	52
L. FLUTE VOICE	37
L.I.T (Lead Initial Touch)	156
LK PRESET	70
LOW (AWM)	117
LOWER KEYBOARD VOICE	26
LOWER RHYTHMIC	135

M

MDR	84
MASTER VOLUME	13
MEM. (MEMORY)	65
MENU (FLUTE VOICE)	40
MENU (KEYBOARD PERCUSSION)	70
METRONOME	128
MIC	157
MIC.VOL	157
MIDI	155, 157, 158
M.O.C. (MELODY ON CHORD)	76
MODE (CHORUS)	55
MODE (DELAY)	47
MODE (FLUTE VOICE)	38
MODE (M.O.C)	76
MODE (PITCH BEND, TEMPO)	152
MODE (REGIST SHIFT)	79
MODE (SYMPHONIC)	46
Modulator (VOICE EDIT)	116
M./TO DISK	77
MUTE (XG Song Playback)	97
Mute (PANEL VOICE)	28

N

NEXT SONG (SHIFT END)	81
NORMAL Set	60, 125, 128

O

OL (AWM)	117
OL (FM)	118, 119
OPERATOR	108, 110, 116
OUTPUT (MIDI)	155

P

PAGE	21
PAN	43
PAN (INSTRUMENT)	60
PATTERN	123
PATTERN DISK	140
Pattern Name (RHYTHM PROGRAM)	138
PAUSE	99
PEDAL VOICE	26
PERCUSSION	59
PITCH	154
PITCH BEND(2ND EXPRESSION)	152
PK PRESET	70
PLAY	87, 95
PLAY PART (XG Song Playback)	97
POSITION (REGIST SHIFT)	81
POSITION (SEQUENCE)	144
POWER	12
Power On Reset	83
PRESET (EFFECT)	43
PRESET (FLUTE VOICE)	40
PRESET (SEQUENCE)	142
PRESET (VIBRATO)	44
Punch In recording	92

Q

QUANTIZE	127, 132
----------------	----------

R

Read and Auto Increment	99
REAL TIME WRITE	127, 133
RECORD	87
Registration Menu Disk	14
REGIST SHIFT	79
Remaining Memory (MDR)	105
Remaining Memory (RHYTHM PROGRAM) ..	137
RESP. (FLUTE VOICE)	38
REV. (REVERB)	43, 49, 60
REVERB	49
RHYTHM	56
Rhythm Condition	59
RHYTHM CONTROL	149
RHYTHM IN	157
Rhythm Menu	63
RHYTHM PROGRAM	122
ROOM (REVERB)	49
RR (AWM)	117
RR (FM)	118

S

SAVE (FLUTE VOICE)	39
SAVE (RHYTHM PROGRAM)	137
SAVE (VOICE EDIT)	112
2ND EXPRESSION	152
SEQ. (SEQUENCE)	141
SET (REGIST SHIFT)	81
SET (REVERB)	49
SET (SEQUENCE)	144
SHIFT END	80
SHIFT (MDR)	86
SHIFT (REGIST SHIFT)	79
Single Finger	65
SLIDE	45
SLOW (CHORUS)	55
SONG COPY	101
SONG DELETE	103
SONG NAME	89
SONG REPEAT	96
SONG SELECT	87
SPEED (FLANGER)	48
SPEED (TREMOLO)	55
SPEED (VIBRATO)	45
START	57
STEP WRITE	127, 129
STOP (CHORUS)	55
STOP (MDR)	88, 95
STOP (SHIFT END)	81
SUSTAIN	52
SYMP. (SYMPHONIC)	44, 46
SYNCHRO START	57

T

TEMPO (MDR)	100
TEMPO (RHYTHM)	58
TEMPO (2ND EXPRESSION)	153
TIME (DELAY)	47
TIME (GLIDE)	149
TIME (SLIDE)	45
TO HOST	157
TO LOWER	28
TOP (SHIFT END)	81
TOUCH TONE	42
TOUCH VIB.	45
TRANSPOSE	154
TREMOLO. (FAST)	55
TREM. (TREMOLO)	43, 46, 55
TUNE	45
TUNE (INSTRUMENT)	60
TYPE (ACCOMPANIMENT)	67
TYPE (REVERB)	49

U

U. FLUTE VOICE	37
UPPER KEYBOARD VOICE	26
USER (FLUTE VOICE)	39
USER (KEYBOARD PERCUSSION)	70
USER (REGIST SHIFT)	80
USER (RHYTHM)	62, 139
USER (SEQUENCE)	141
USER (VIBRATO)	44
USER (PANEL VOICE)	30, 113

V

VIBRATO	44
Voice Condition	42
VOICE DISK	115
VOICE DISPLAY	28
VOIC EDIT	107
Voice Menu	31
Voice Name (VOICE EDIT)	113
Voice Sections	26
VOL. (VOLUME; ACCOMPANIMENT)	67
VOL. (FLUTE VOICE)	38
VOL. (INSTRUMENT)	60
VOL. (PERCUSSION)	59
VOL. (PANEL VOICE)	27, 43
VOL. (XG Song)	97

X

XG Easy Converter	98
XG Song Playback	97

IMPORTANT NOTICE FOR THE UNITED KINGDOM

Connecting the Plug and Cord

IMPORTANT. The wires in this mains lead are coloured in accordance with the following code:

BLUE : NEUTRAL
BROWN : LIVE

As the colours of the wires in the mains lead of this apparatus may not correspond with the coloured markings identifying the terminals in your plug proceed as follows:

The wire which is coloured BLUE must be connected to the terminal which is marked with the letter N or coloured BLACK.

The wire which is coloured BROWN must be connected to the terminal which is marked with the letter L or coloured RED.

Making sure that neither core is connected to the earth terminal of the three pin plug.

(2 wires)

- This applies only to products distributed by Yamaha-Kemble Music (U.K.) Ltd.

For details of products, please contact your nearest Yamaha or the authorized distributor listed below.

EUROPE

THE UNITED KINGDOM

Yamaha-Kemble Music (U.K.) Ltd.
Sherbourne Drive, Tilbrook, Milton Keynes,
MK7 8BL, England
Tel: 01908-366700

OTHER EUROPEAN COUNTRIES

**Yamaha Corporation,
Electronic Musical Instrument Division**
Nakazawa-cho 10-1, Hamamatsu, Japan 430-8650
Tel: 053-460-3273

CENTRAL & SOUTH AMERICA

MEXICO

**Yamaha de Mexico S.A. De C.V.,
Departamento de ventas**
Javier Rojo Gomez No.1149, Col. Gpe Del
Moral, Deleg. Iztapalapa, 09300 Mexico, D.F.
Tel: 686-00-33

BRAZIL

Yamaha Musical do Brasil LTDA.
Av. Rebouças 2636, São Paulo, Brasil
Tel: 011-853-1377

ARGENTINA

Yamaha Music Argentina S.A.
Viamonte 1145 Piso2-B 1053,
Buenos Aires, Argentina
Tel: 1-371-7021

PANAMA AND OTHER LATIN AMERICAN COUNTRIES/ CARIBBEAN COUNTRIES

Yamaha de Panama S.A.
Torre Banco General, Piso 7, Urbanización Marbella,
Calle 47 y Aquilino de la Guardia,
Ciudad de Panamá, Panamá
Tel: 507-269-5311

AFRICA

**Yamaha Corporation,
International Marketing Division**
Nakazawa-cho 10-1, Hamamatsu, Japan 430-8650
Tel: 053-460-2312

MIDDLE EAST

* Except Turkey and Cyprus.

Yamaha Music Gulf FZE
LB21-128 Jebel Ali Freezone
P.O.Box 17328, Dubai, U.A.E.
Tel: 971-4-81-5868

ASIA

HONG KONG

Tom Lee Music Co., Ltd.
11/F., Silvercord Tower 1, 30 Canton Road,
Tsimshatsui, Kowloon, Hong Kong
Tel: 2737-7688

INDONESIA

**PT. Yamaha Music Indonesia (Distributor)
PT. Nusantik**
Gedung Yamaha Music Center, Jalan Jend. Gatot Subroto
Kav. 4, Jakarta 12930, Indonesia
Tel: 21-520-2577

KOREA

Cosmos Corporation
1461-9, Seocho Dong, Seocho Gu, Seoul, Korea
Tel: 02-3486-0011

MALAYSIA

Yamaha Music Malaysia, Sdn., Bhd.
Lot 8, Jalan Perbandaran, 47301 Kelana Jaya,
Petaling Jaya, Selangor, Malaysia
Tel: 3-703-0900

PHILIPPINES

Yupango Music Corporation
339 Gil J. Puyat Avenue, P.O. Box 885 MCPO,
Makati, Metro Manila, Philippines
Tel: 819-7551

SINGAPORE

Yamaha Music Asia Pte., Ltd.
11 Ubi Road #06-00, Meiban Industrial Building,
Singapore
Tel: 65-747-4374

TAIWAN

Yamaha KHS Music Co., Ltd.
10F, 150, Tun-Hwa Northroad,
Taipei, Taiwan, R.O.C.
Tel: 02-2713-8999

THAILAND

Siam Music Yamaha Co., Ltd.
121/60-61 RS Tower 17th Floor,
Ratchadaphisek RD., Dindaeng,
Bangkok 10320, Thailand
Tel: 02-641-2951

THE PEOPLE'S REPUBLIC OF CHINA AND OTHER ASIAN COUNTRIES

**Yamaha Corporation,
International Marketing Division**
Nakazawa-cho 10-1, Hamamatsu, Japan 430-8650
Tel: 053-460-2312

OCEANIA

AUSTRALIA

Yamaha Music Australia Pty. Ltd.
17-33 Market Street, South Melbourne, Vic. 3205,
Australia
Tel: 3-699-2388

NEW ZEALAND

Music Houses of N.Z. Ltd.
146/148 Captain Springs Road, Te Papapa, Auckland,
New Zealand
Tel: 9-634-0099

COUNTRIES AND TRUST TERRITORIES IN PACIFIC OCEAN

**Yamaha Corporation,
International Marketing Group**
Nakazawa-cho 10-1, Hamamatsu, Japan 430-8650
Tel: 053-460-2312

HEAD OFFICE

EUROPE

Yamaha Corporation, Electronic Musical Instrument Division
Nakazawa-cho 10-1, Hamamatsu, Japan 430-8650
Tel: 053-460-3273

CENTRAL & SOUTH AMERICA, AFRICA, MIDDLE EAST, ASIA, OCEANIA

Yamaha Corporation, International Marketing Group
Nakazawa-cho 10-1, Hamamatsu, Japan 430-8650
Tel: 053-460-2312



YAMAHA
YAMAHA CORPORATION