

DIGITAL KEYBOARD

PSR-F52



OWNER'S MANUAL

Before using the instrument, be sure to read "PRECAUTIONS" on pages 3–4.

PRECAUTIONS	3
Included Accessories	5
Song Book (Online Material)	5
Power Requirements	5
Basic Operations	6
Voices/Songs/Styles	8
The Functions	9
Troubleshooting	10
Specifications	10
Voice/Drum Kit/Style/Song List	11
Smart Chord Chart	16
Reading the Score	17

FCC INFORMATION (U.S.A.)

1. IMPORTANT NOTICE: DO NOT MODIFY THIS UNIT!

This product, when installed as indicated in the instructions contained in this manual, meets FCC requirements. Modifications not expressly approved by Yamaha may void your authority, granted by the FCC, to use the product.

2. IMPORTANT:

When connecting this product to accessories and/or another product use only high quality shielded cables. Cable/s supplied with this product MUST be used. Follow all installation instructions. Failure to follow instructions could void your FCC authorization to use this product in the USA.

3. NOTE:

This product has been tested and found to comply with the requirements listed in FCC Regulations, Part 15 for Class "B" digital devices. Compliance with these requirements provides a reasonable level of assurance that your use of this product in a residential environment will not result in harmful interference with other electronic devices. This equipment generates/uses radio frequencies and, if not installed and used according to the instructions found in the users manual, may cause interference harmful to the operation of other electronic devices. Compliance with FCC regulations does not guarantee that interference will not occur in all installations. If this product is found to be the source of interference, which can be determined by turning the unit

"OFF" and "ON," please try to eliminate the problem by using one of the following measures:
Relocate either this product or the device that is being affected by the interference.

Utilize power outlets that are on different branch (circuit breaker or fuse) circuits or install AC line filter/s.

In the case of radio or TV interference, relocate/reorient the antenna. If the antenna lead-in is 300 ohm ribbon lead, change the lead-in to co-axial type cable.

If these corrective measures do not produce satisfactory results, please contact the local retailer authorized to distribute this type of product. If you can not locate the appropriate retailer, please contact Yamaha Corporation of America, 6600 Orangethorpe Ave. Buena Park CA90620, USA. The above statements apply ONLY to those products distributed by Yamaha Corporation of America or its subsidiaries.

* This applies only to products distributed by Yamaha Corporation of America.

(class B)

COMPLIANCE INFORMATION STATEMENT (Supplier's declaration of conformity procedure)

Responsible Party : Yamaha Corporation of America
Address : 6600 Orangethorpe Ave., Buena Park, Calif. 90620
Telephone : 714-522-9011
Type of Equipment : Digital Keyboard
Model Name : PSR-F52

This device complies with Part 15 of the FCC Rules.

Operation is subject to the following two conditions:

- 1) this device may not cause harmful interference, and
- 2) this device must accept any interference received including interference that may cause undesired operation.

* This applies only to products distributed by Yamaha Corporation of America.

(FCC SDoC)

For the AC adaptor



Explanation of Graphical Symbols



The lightning flash with arrowhead symbol within an equilateral triangle is intended to alert the user to the presence of uninsulated "dangerous voltage" within the product's enclosure that may be of sufficient magnitude to constitute a risk of electric shock to persons.



The exclamation point within an equilateral triangle is intended to alert the user to the presence of important operating and maintenance (servicing) instructions in the literature accompanying the product.

IMPORTANT SAFETY INSTRUCTIONS

- 1 Read these instructions.
- 2 Keep these instructions.
- 3 Heed all warnings.
- 4 Follow all instructions.
- 5 Do not use this apparatus near water.
- 6 Clean only with dry cloth.
- 7 Do not block any ventilation openings. Install in accordance with the manufacturer's instructions.
- 8 Do not install near any heat sources such as radiators, heat registers, stoves, or other apparatus (including amplifiers) that produce heat.
- 9 Do not defeat the safety purpose of the polarized or grounding-type plug. A polarized plug has two blades with one wider than the other. A grounding type plug has two blades and a third grounding prong. The wide blade or the third prong are provided for your safety. If the provided plug does not fit into your outlet, consult an electrician for replacement of the obsolete outlet.
- 10 Protect the power cord from being walked on or pinched particularly at plugs, convenience receptacles, and the point where they exit from the apparatus.
- 11 Only use attachments/accessories specified by the manufacturer.
- 12 Use only with the cart, stand, tripod, bracket, or table specified by the manufacturer, or sold with the apparatus. When a cart is used, use caution when moving the cart/apparatus combination to avoid injury from tip-over.
- 13 Unplug this apparatus during lightning storms or when unused for long periods of time.
- 14 Refer all servicing to qualified service personnel. Servicing is required when the apparatus has been damaged in any way, such as power-supply cord or plug is damaged, liquid has been spilled or objects have fallen into the apparatus, the apparatus has been exposed to rain or moisture, does not operate normally, or has been dropped.



WARNING TO REDUCE THE RISK OF FIRE OR ELECTRIC SHOCK, DO NOT EXPOSE THIS APPARATUS TO RAIN OR MOISTURE.

PRECAUTIONS

PLEASE READ CAREFULLY BEFORE PROCEEDING

Please keep this manual in a safe and handy place for future reference.

For the AC adaptor

WARNING

- This AC adaptor is designed for use with only Yamaha electronic instruments. Do not use for any other purpose.
- Indoor use only. Do not use in any wet environments.

CAUTION

- When setting up, make sure that the AC outlet is easily accessible. If some trouble or malfunction occurs, immediately turn off the power switch of the instrument and disconnect the AC adaptor from the outlet. When the AC adaptor is connected to the AC outlet, keep in mind that electricity is flowing at the minimum level, even if the power switch is turned off. When you are not using the instrument for a long time, make sure to unplug the power cord from the wall AC outlet.

For the instrument

WARNING

Always follow the basic precautions listed below to avoid the possibility of serious injury or even death from electrical shock, short-circuiting, damages, fire or other hazards. These precautions include, but are not limited to, the following:

Power supply/AC adaptor

- Do not place the power cord near heat sources such as heaters or radiators. Also, do not excessively bend or otherwise damage the cord, or place heavy objects on it.
- Only use the voltage specified as correct for the instrument. The required voltage is printed on the name plate of the instrument.
- Use the specified adaptor (page 10) only. Using the wrong adaptor can result in damage to the instrument or overheating.
- Check the electric plug periodically and remove any dirt or dust which may have accumulated on it.

Do not open

- This instrument contains no user-serviceable parts. Do not open the instrument or attempt to disassemble or modify the internal components in any way. If it should appear to be malfunctioning, discontinue use immediately and have it inspected by qualified Yamaha service personnel.

Water warning

- Do not expose the instrument to rain, use it near water or in damp or wet conditions, or place on it any containers (such as vases, bottles or glasses) containing liquids which might spill into any openings. If any liquid such as water seeps into the instrument, turn off the power immediately and unplug the power cord from the AC outlet. Then have the instrument inspected by qualified Yamaha service personnel.
- Never insert or remove an electric plug with wet hands.

Fire warning

- Do not put burning items, such as candles, on the unit. A burning item may fall over and cause a fire.

Influences on electro-medical

- Magnetism may affect electro-medical devices.
 - Do not use this product near medical devices or inside areas in which the use of radio waves is restricted.
 - Do not use this product within 15cm (6 in.) of persons with a heart pacemaker or defibrillator implant.

Battery

- Follow the precautions below. Failure to do so might result in explosion, fire, overheating or battery fluid leakage.
 - Do not tamper with or disassemble batteries.
 - Do not dispose of batteries in fire.
 - Do not expose a battery to high temperatures, such as direct sunlight or a fire.
 - Do not attempt to recharge batteries that are not designed to be charged.
 - Keep the batteries separate from metallic objects such as necklaces, hairpins, coins, and keys.
 - Use the specified battery type (page 10) only.
 - Use new batteries, all of which are the same type, same model, and made by the same manufacturer.
 - Always make sure all batteries are inserted in conformity with the +/- polarity markings.
 - When the batteries run out, or if the instrument is not to be used for a long time, remove the batteries from the instrument.
 - When using Ni-MH batteries, follow the instructions that came with the batteries. Use only the specified charger device when charging.
- Keep batteries away from small children who might accidentally swallow them.
- If the batteries do leak, avoid contact with the leaked fluid. If the battery fluid should come in contact with your eyes, mouth, or skin, wash immediately with water and consult a doctor. Battery fluid is corrosive and may possibly cause loss of sight or chemical burns.

If you notice any abnormality

- When one of the following problems occur, immediately turn off the power switch and disconnect the electric plug from the outlet. (If you are using batteries, remove all batteries from the instrument.) Then have the device inspected by Yamaha service personnel.
 - The power cord or plug becomes frayed or damaged.
 - It emits unusual smells or smoke.
 - Some object has been dropped into the instrument.
 - There is a sudden loss of sound during use of the instrument.
 - If any cracks or breakages exist on the instrument.

CAUTION

Always follow the basic precautions listed below to avoid the possibility of physical injury to you or others, or damage to the instrument or other property. These precautions include, but are not limited to, the following:

Power supply/AC adaptor

- Do not connect the instrument to an electrical outlet using a multipleconnector. Doing so can result in lower sound quality, or possibly cause overheating in the outlet.
- When removing the electric plug from the instrument or an outlet, always hold the plug itself and not the cord. Pulling by the cord can damage it.
- Remove the electric plug from the outlet when the instrument is not to be used for extended periods of time, or during electrical storms.

Location

- Do not place the instrument in an unstable position where it might accidentally fall over.
- Before moving the instrument, remove all connected cables, to prevent damage to the cables or injury to anyone who might trip over them.
- When setting up the product, make sure that the AC outlet you are using is easily accessible. If some trouble or malfunction occurs, immediately turn off the power switch and disconnect the plug from the outlet. Even when the power switch is turned off, electricity is still flowing to the product at the minimum level. When you are not using the product for a long time, make sure to unplug the power cord from the wall AC outlet.
- Use only the stand specified for the instrument. When attaching it, use the provided screws only. Failure to do so could cause damage to the internal components or result in the instrument falling over.

Connections

- Before connecting the instrument to other electronic components, turn off the power for all components. Before turning the power on or off for all components, set all volume levels to minimum.
- Be sure to set the volumes of all components at their minimum levels and gradually raise the volume controls while playing the instrument to set the desired listening level.

Handling

- Never insert or drop paper, metallic, or other objects into the gaps on the panel or keyboard. This could cause physical injury to you or others, damage to the instrument or other property, or operational failure.
- Do not rest your weight on, or place heavy objects on the instrument, and do not use excessive force on the buttons, switches or connectors.
- Do not use the instrument or headphones for a long period of time at a high or uncomfortable volume level, since this can cause permanent hearing loss. If you experience any hearing loss or ringing in the ears, consult a physician.

Yamaha cannot be held responsible for damage caused by improper use or modifications to the instrument, or data that is lost or destroyed.

Always turn the power off when the instrument is not in use.

Even when the [] (Standby/On) switch is in standby status (display is off), electricity is still flowing to the instrument at the minimum level.

When you are not using the instrument for a long time, make sure you unplug the power cord from the wall AC outlet.

Make sure to discard used batteries according to local regulations.

DMI-7 2/2

NOTICE

To avoid the possibility of malfunction/ damage to the product, damage to data, or damage to other property, follow the notices below.

■ Handling

- Do not use the instrument in the vicinity of a TV, radio, stereo equipment, mobile phone, or other electric devices. Otherwise, the instrument, TV, or radio may generate noise.
- When you use the instrument along with an app on your smart device, such as a smartphone or tablet, we recommend that you enable "Airplane Mode" on the device to avoid noise caused by communication.
- Depending on the condition of surrounding radio waves, the instrument may possibly malfunction.
- Do not expose the instrument to excessive dust or vibrations, or extreme cold or heat (such as in direct sunlight, near a heater, or in a car during the day) to prevent the possibility of panel disfiguration, damage to the internal components or unstable operation. (Verified operating temperature range: 5° – 40°C, or 41° – 104°F.)
- Do not place vinyl, plastic or rubber objects on the instrument, since this might discolor the panel or keyboard.
- Do not press the display with your finger because it is a sensitive, precision-made part.

■ Maintenance

- When cleaning the instrument, use a soft cloth. Do not use paint thinners, solvents, alcohol, cleaning fluids, or chemical-impregnated wiping cloths.

Information

■ About copyrights

- The copyright of the "content"*1 installed in this product belongs to Yamaha Corporation or its copyright holder. Except as permitted by copyright laws and other relevant laws, such as copying for personal use, it is prohibited to "reproduce or divert"*2 without the permission of the copyright holder. When using the content, consult with a copyright expert.

If you create music or perform with the contents through the original use of the product, and then record and distribute them, the permission of Yamaha Corporation is not required regardless of whether the distribution method is paid or free of charge.

*1: The word "content" includes a computer program, audio data, Accompaniment Style data, MIDI data, waveform data, voice recording data, music score, and score data, etc.

*2: The phrase "reproduce or divert" includes taking out the content itself in this product, or recording and distributing it without changes in a similar manner.

■ About functions/data bundled with the instrument

- Some of the preset songs have been edited for length or arrangement, and may not be exactly the same as the original.

■ About this manual

- The illustrations and displays as shown in this manual are for instructional purposes only, and may appear somewhat different from those on your instrument.
- The company names and product names in this manual are the trademarks or registered trademarks of their respective companies.

Square brackets []

The names of panel buttons and jacks are enclosed in square brackets. Also, the word "button" is omitted throughout this manual (for example, the START/STOP button is expressed as [START/STOP]).

The model number, serial number, power requirements, etc., may be found on or near the name plate, which is at the bottom of the unit.

You should note this serial number in the space provided below and retain this manual as a permanent record of your purchase to aid identification in the event of theft.

Model No. _____

Serial No. _____

(bottom_en_01)

Thank you for purchasing this Yamaha Digital Keyboard!

This instrument is a portable keyboard featuring a wide variety of sounds and functions.

We recommend that you read this manual carefully so that you can fully take advantage of the advanced and convenient functions of the instrument. We also recommend that you keep this manual in a safe and handy place for future reference.

Included Accessories

- Owner's Manual (this book) (1)
- AC adaptor (1)
 - * May not be included depending on your particular locale. Check with your Yamaha dealer.
- Online Member Product Registration (1)
- Music rest (1)

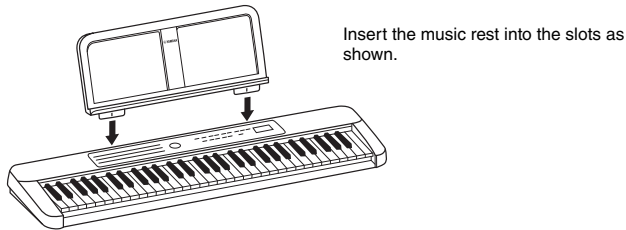

Song Book (Online Material)

This contains music scores for the preset Songs (excepting for Song No. 001) of this instrument. To obtain this Song Book, access the Yamaha website and download it from the product web page.
Yamaha Global Site <https://www.yamaha.com>



Song Book

Power Requirements

Although the instrument will run either from an AC adaptor or batteries, it is recommended to use an AC adaptor whenever possible.

Using an AC Adaptor

⚠ WARNING

- Follow the precautions in the "Power Supply/AC adaptor" section on page 3.

Connect the AC adaptor in the order shown in the illustration.

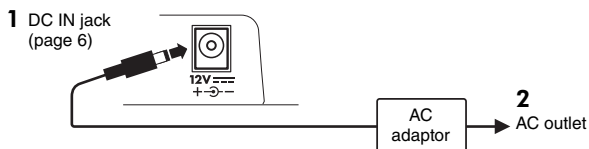

⚠ WARNING

- When using the AC adaptor with a removable plug, make sure to keep the plug attached to the AC adaptor. Using the plug alone can cause electric shock or fire.
- If the plug is accidentally removed from the AC adaptor, slide it back in until it clicks into place, taking care to avoid touching any internal metal parts. To avoid electric shock, short circuit or damage, also be careful that there is no dust between the AC adaptor and plug.

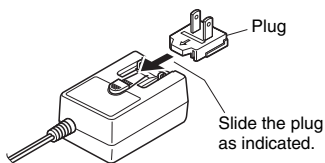

The shape of the plug differs depending on your area.

⚠ CAUTION

- When setting up the product, make sure that the AC outlet you are using is easily accessible. If some trouble or malfunction occurs, immediately turn the power off and disconnect the plug from the outlet.

NOTE

- Follow the order shown above in reverse when disconnecting the AC adaptor.

Using Batteries

This instrument requires six "AA" size, Alkaline (LR6)/Manganese (R6) batteries, or rechargeable Ni-MH (HR6) batteries. The Alkaline batteries or rechargeable Ni-MH batteries are recommended for this instrument, since other types may result in poorer battery performance.

⚠ WARNING

- Follow the precautions in the "Battery" section on page 3.

- 1 Make sure that the power of the instrument is off.
- 2 Open the battery compartment cover located on the instrument's bottom panel.

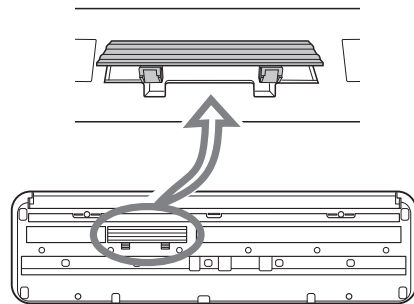

- 3 Insert the six new batteries, being careful to follow the polarity markings on the inside of the compartment.

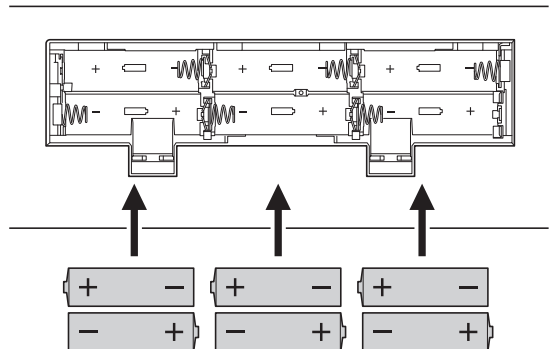

- 4 Replace the compartment cover, making sure that it locks firmly in place.

Make sure to set the battery type correctly (page 10).

NOTICE

- When battery power becomes too low for proper operation, the volume may be reduced, the sound may be distorted, and other problems may occur. When this happens, make sure to replace all batteries with new ones or already recharged ones.

NOTE

- This instrument cannot charge the batteries. Use only the specified charger device when charging.
- Power will be automatically drawn from the AC adaptor if an AC adaptor is connected while batteries are installed in the instrument.

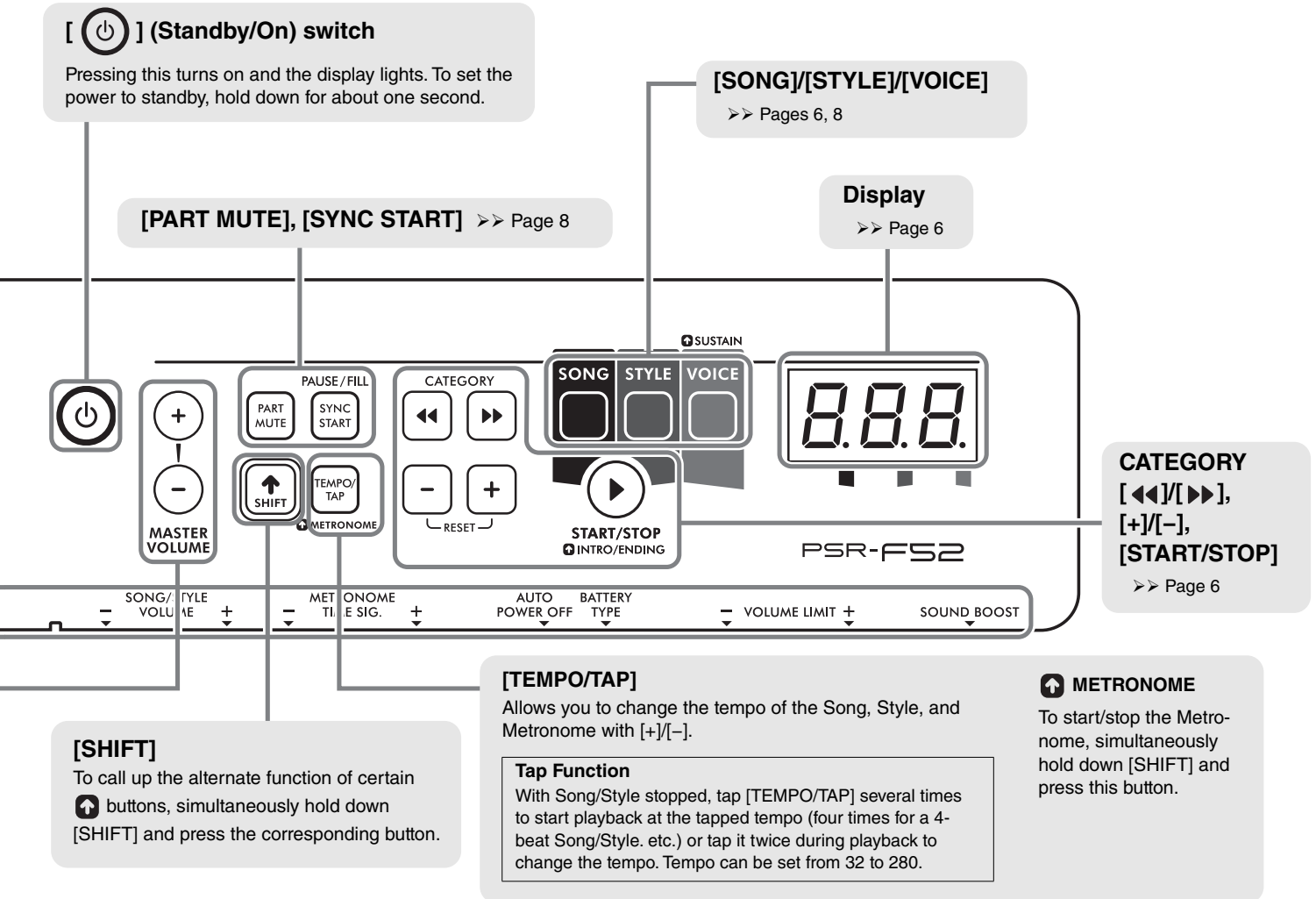

2 Use CATEGORY [<<]/[>>] or [+]/[-] to select the desired Song/Style/Voice.

You can check the Song/Style/Voice categories on the front panel.

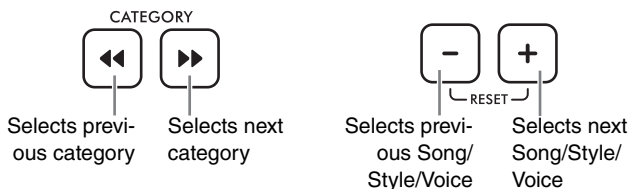

3 Play the keyboard, or press [START/STOP] to start the Song/Style.

To stop the Song or Style, press [START/STOP] again.

* In Style playback, an Intro plays back first, and then only the rhythm part plays back, because of the Auto Intro/Ending function (page 9). Some Styles do not include a rhythm part.

* For further information on Song/Style/Voice, see page 8.

Backup and Initialization

Backup Parameters

The following settings will be maintained even if the power is turned off.

- Master Volume
- Volume Limit
- Tuning
- Chord Fingering Type
- Auto Power Off
- Battery Type

Initialization

To initialize the backup parameters, press the [Standby/On] switch while holding down the highest white key to turn the power on. “L r” appears on the display.

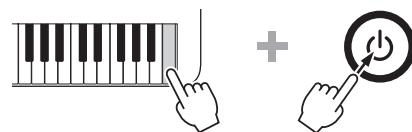

➤➤ To select and play a Voice/Song/Style, see page 6.

Voices

The Voices are the heart of the PSR-F52, letting you play 144 realistic instrument sounds (page 11) from the keyboard.

When selecting a Voice and playing the PSR-F52, the following functions are useful.

OTS (One Touch Setting; Voice No. 000)

After you've selected a Song/Style, simply selecting Voice No. 000 automatically calls up the most appropriate Voice for playing with that Song/Style.

Sustain

To turn this function on/off, simultaneously hold down [SHIFT] and press [VOICE]. When this is set to on, the Voices played from the keyboard have a long decay or sustain.



Sound Boost >> Page 9

This function is useful for playing more loudly and powerfully without using an external speaker.

Duo

When this function is on, the keyboard is split into two sections (C1–F#3 and G3–C6), with the same Voice and octave range. This is useful for playing or learning with two players (for example, a student and a teacher).

For instructions on turning this function on/off, see page 9.

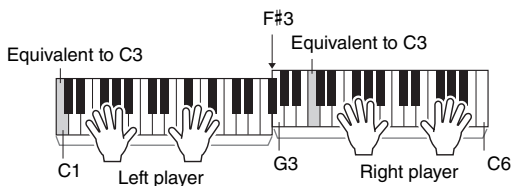

"C1" or "C3," etc. are example note names. For more note names, see the illustration on page 9.

Songs

The PSR-F52 contains 69 specially recorded pieces (page 15)—for playing and practicing along with, or just for listening.

➤➤ Download the free Digital Song Book (page 5) and have fun practicing the Songs!

Use the buttons below to control playback as desired.

PAUSE/FILL — When Song playback is stopped, you can start the Song by simply playing a key.
During Song playback, you can pause/resume the Song.

TEMPO/TAP — Calls up the Tempo, letting you change the setting. >> page 7

METRONOME — Mutes the right/left track of a Song, letting you play or practice the muted part yourself. Press this button repeatedly to select the desired part for muting.
 * When both parts are muted, play either the right or left part.

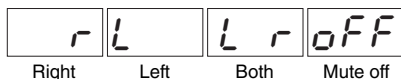

Styles

The Styles give you authentic, automatic backing in a wide variety of music genres. Just play the root notes of chords with your left hand, and enjoy the accompaniment of a full band behind you!

After selecting a Style (page 6), the area of the keyboard to the left of the F#2 key becomes the "Auto Accompaniment range" and is used only for specifying the chords.

Select Style No. 65 "6/8 March" and try playing the root notes of chords with your left hand while you play a melody over the accompaniment with your right.

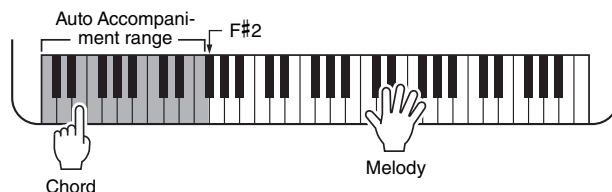

If You're Happy and You Know It

RIGHT
staccato F C7 F

LEFT
F C7 F

* If sharps (#) or flats (b) are written on your music score, you need to set the "⑥ Smart Chord Key" on page 9 before playing with a Style.

In Style playback, use the buttons below as desired.

PAUSE/FILL — When Style playback is stopped, you can start Style by simply playing a key.
During Style playback, you can play a Fill-in, to add rhythmic interest to your performance.
 * The PIANIST category Styles have no Fill-in sections.

TEMPO/TAP — Calls up the Tempo, letting you change the setting. >> page 7

METRONOME — Mutes the accompaniment part so that you play only with the rhythm part. To restore the accompaniment, press it again and play a key in the Auto Accompaniment range.

Intro and Ending

By default, both Intro and Ending patterns are added to the beginning and end of the Style playback automatically, because of the Auto Intro/Ending function (page 9).

If you want to add an Intro and Ending by yourself, turn off the Auto Intro/Ending function and simultaneously hold down [SHIFT] and press [START/STOP], before starting/finishing Style playback.

Chord Fingering Type >> Page 9

How you play the chords when playing Styles is called "Fingering Type." With this instrument, you can choose from two Fingering Types. The default setting is "Smart Chord."

➤➤ To use the Voice over the whole range in the Style mode, press [PART MUTE].

The Functions



To set the various Functions, press the appropriate key (repeatedly if necessary) while holding down [SHIFT].

Function List

Function Name	Descriptions	Default Value	Range/Settings
① Transpose	Determines the pitch of the instrument in semitone increments.	00	-12–0–12
② Tuning	Determines the fine tuning of the pitch of the entire instrument in approx. 0.2Hz increments. The hundreds digit of the setting value is omitted on the display.	440.0	427.0(2 70)– 440.0(4 00)– 453.0(5 30)
③ Duo	Switches the Duo function on/off (page 8).	Off (d o F)	On (d o n) / Off (d o F)
④ Auto Intro/Ending	Switches the Auto Intro/Ending function on/off (page 8).	On (R o n)	On (R o n) / Off (R o F)
⑤ Chord Fingering Type	Determines how to play the chord in Auto Accompaniment range (page 8) when playing with a Style. <ul style="list-style-type: none"> Smart Chord (S n r): Simply play the root note of a chord, and the appropriate chord plays according to the key. For best results, set the “⑥ Smart Chord Key” below before playing. Multi Finger (n l t): This is a way to play the Style by playing all notes of a chord. <p>NOTE</p> <ul style="list-style-type: none"> When setting the Fingering Type to Smart Chord, the melody of some Songs may not be suitable for the chord. For details on available chords you can play, refer to “Smart Chord Chart” on page 16. 	Smart Chord (S n r)	Smart Chord (S n r) / Multi Finger (n l t)
⑥ Smart Chord Key	Determines the Key Signature when the Chord Fingering Type is set to “Smart Chord.” For example, if the music score shows 1 flat (b), press the G3 or F3 key until “FL1” appears on the display. <p>Key Signature (Key in F major)</p>	No Key Signature (S P 0: C Major or A Minor)	7 Flats (F L 7)–0 (S P 0)– 7 Sharps (S P 7)
⑦ Song/Style/Metronome Volume	Determines the Song/Style/Metronome volume.	12	00–15
⑧ Metronome Time Signature	Determines the Metronome beat. For example, when this is set to 4, the beat is set to 4/4 time and the first beat is accented with a bell sound.	The current Song or Style Beat	0 (no beat)–16
⑨ Auto Power Off	Specifies the time that will elapse before the instrument’s power is automatically turned off.	30 minutes	oFF/5/10/15/30/60/120 (minutes)
⑩ Battery Type	Selects the type of batteries you have installed to this instrument.	Alkaline battery / Manganese battery (R L)	R L: Alkaline battery / Manganese battery n i: Rechargeable battery (Ni-MH)
⑪ Volume Limit	Determines the maximum value of the Master Volume.	15	01–15
⑫ Sound Boost	Switches the Sound Boost on/off (page 8). <p>NOTE</p> <ul style="list-style-type: none"> When the Sound Boost function is on, the sound may become more distorted. 	Off (b o F)	On (b o n) / Off (b o F)

Troubleshooting

Problem	Solution
When the instrument is turned on or off, a popping sound is temporarily produced.	This is normal and indicates that the instrument is receiving electrical power.
<ul style="list-style-type: none"> No Sound. The volume is too soft. 	<ul style="list-style-type: none"> Disconnect the headphones from [PHONES/OUTPUT] (page 6). Check whether the Volume Limit setting (page 9) is too low or not. Replace all the batteries with new ones or recharged ones.
The auto accompaniment of the Style does not play.	The auto accompaniment may be muted. Press [PART MUTE].
Power suddenly and unexpectedly turns off.	This is normal and the Auto Power Off function (page 9) may have been activated. If you need to disable the Auto Power Off function, select "OFF".
When the instrument is turned on, power is turned off suddenly and unexpectedly.	The protection circuit has been activated due to overcurrent. This may occur when an AC adaptor other than the one specified is used, or an AC adaptor is damaged. Use the specified adaptor (see below) only. If it should appear to be malfunctioning, please consult Yamaha service personnel.

Specifications

Product Name	Digital keyboard
Dimensions (W x D x H)	920 mm x 266 mm x 73 mm (36-1/4" x 10-1/2" x 2-7/8")
Weight	2.8 kg (6 lb, 3 oz) (not including batteries)
Keyboard	61 standard-size key
Display	7-Segment LED
Panel Language	English
Voices	<ul style="list-style-type: none"> Preset: 136 Voices (including 41 World Voices) + 8 Drum Kits (including 5 World Drum Kits) Polyphony (max.): 32
Accompaniment Styles	<ul style="list-style-type: none"> Preset: 158 (including 75 World Styles) Fingering: Smart Chord, Multi Finger Style Controls: Fill-in, Intro/Ending (Auto/Manual)
Songs (MIDI data only; audio not supported.)	Preset: 69 (including 1 Demo Song)
Functions	<ul style="list-style-type: none"> One Touch Setting Panel Sustain Sync Start Part Mute Metronome Tempo Range: 11–280 (32–280, Tap Tempo) Duo Transpose: -12–0–+12 Tuning: 427.0–440.0–453.0 Hz (approx. 0.2 Hz increments) Sound Boost Volume Limit

Terminals	<ul style="list-style-type: none"> DC IN: 12 V Headphones/Output: Stereo mini jack (PHONES/OUTPUT)
Amplifiers	2.5 W x 2
Speakers	8 cm x 2
Power Supply	<ul style="list-style-type: none"> AC Adaptor: PA-130 or an equivalent recommended by Yamaha (Output: DC 12 V, 0.7 A or 1.0 A) Batteries: Six "AA" size alkaline (LR6), manganese (R6) or Ni-MH rechargeable (HR6) batteries
Power Consumption	6 W (When using PA-130B AC adaptor)
Auto Power Off	Off/5/10/15/30/60/120(minutes)
Included Accessories	<ul style="list-style-type: none"> Owner's Manual Online Member Product Registration Music Rest AC adaptor* (PA-130 or an equivalent recommended by Yamaha) <p>* May not be included depending on your particular area. Please check with your dealer.</p>
Separately Sold Accessories (May not be available depending on your area.)	<ul style="list-style-type: none"> AC adaptor: Users in the U.S.A. or Europe: PA-130 or an equivalent recommended by Yamaha Others: PA-3C, PA-130 or an equivalent Headphones: HPH-50/HPH-100/HPH-150

* The contents of this manual apply to the latest specifications as of the publishing date. To obtain the latest manual, access the Yamaha website then download the manual file. Since specifications, equipment or separately sold accessories may not be the same in every locale, please check with your Yamaha dealer.

Information for users on collection and disposal of old equipment and used batteries:



These symbols on the products, packaging, and/or accompanying documents mean that used electrical and electronic products and batteries should not be mixed with general household waste. For proper treatment, recovery and recycling of old products and used batteries, please take them to applicable collection points, in accordance with your national legislation.

By disposing of these products and batteries correctly, you will help to save valuable resources and prevent any potential negative effects on human health and the environment which could otherwise arise from inappropriate waste handling.

For more information about collection and recycling of old products and batteries, please contact your local municipality, your waste disposal service or the point of sale where you purchased the items.

For business users in the European Union:

If you wish to discard electrical and electronic equipment, please contact your dealer or supplier for further information.

Information on Disposal in other Countries outside the European Union:

These symbols are only valid in the European Union. If you wish to discard these items, please contact your local authorities or dealer and ask for the correct method of disposal.



Note for the battery symbol (bottom two symbol examples):

This symbol might be used in combination with a chemical symbol. In this case it complies with the requirement set by the EU Battery Directive for the chemical involved.

Cd

(weee_battery_eu_en_02)

Voice List / Liste der Voices / Liste des sonorités / Lista de voces / Lista de vozes / Elenco delle voci / Voiceoverzicht / Lista brzmień / Liste over lyde / Lista över ljud / Seznam rejstříků / Zoznam hlasov / Hangszínek listája / Seznam zvokov / Списък с тонове / Listă de voci / Skaņu saraksts / Garsų sąrašas / Helide loend / Popis zvukova / Enstrüman Sesi Listesi / Danh sách tiếng / قائمة الأصوات

Voice No.	Voice Name
PIANO & E.PIANO	
1	Grand Piano
2	Bright Piano
3	Honky Tonk Piano
4	Harpsichord
5	Electric Piano 1
6	Electric Piano 2
7	Electric Grand
ORGAN	
8	Drawbar Organ
9	Percussive Organ
10	Rock Organ
11	Pipe Organ
12	Reed Organ
ACCORDION	
13	Accordion
14	Tango Accordion
15	Harmonica
GUITAR & BASS	
16	Nylon Guitar
17	Steel Guitar
18	12Strings Guitar
19	Jazz Guitar
20	Clean Guitar
21	Muted Guitar
22	Overdriven Guitar
23	Distortion Guitar
24	Ukulele
25	Acoustic Bass
26	Finger Bass
27	Pick Bass
28	Fretless Bass
29	Slap Bass
30	Synth Bass
STRINGS	
31	Strings 1
32	Strings 2
33	Synth Strings
34	Pizzicato Strings
35	Violin
36	Viola
37	Cello
38	Contrabass
39	Orchestral Harp
WOODWIND	
40	Flute
41	Piccolo
42	Recorder
43	Oboe
44	Clarinet
45	Bassoon
SAXOPHONE	
46	Tenor Sax
47	Alto Sax

Voice No.	Voice Name
48	Soprano Sax
49	Baritone Sax
BRASS	
50	Brass Section
51	Trumpet
52	Trombone
53	French Horn
54	Tuba
55	Synth Brass
PERCUSSION	
56	Vibraphone
57	Marimba
58	Celesta
59	Timpani
SYNTH	
60	Square Lead
61	Sawtooth Lead
62	Bass & Lead
63	New Age Pad
64	Warm Pad
65	Halo Pad
66	Crystal
67	Brightness
WORLD	
68	Pan Flute
69	Ocarina
70	Banjo
71	Bagpipe
72	Dulcimer 1
73	Dulcimer 2
74	Gamelan Gongs
75	Suling
76	Bonang
77	Gender
78	Rama Cymbal
79	Thai Bells
80	Koto
81	Indonesian Kit 1
82	Indonesian Kit 2
83	Er Hu
84	Ma Tou Qin
85	Pi Pa
86	Yang Qin
87	Gu Zheng
88	Di Zi
89	Chinese Kit
90	Tanpura
91	Harmonium 1 (Single Reed)
92	Harmonium 2 (Double Reed)
93	Harmonium 3 (Triple Reed)
94	Pungi
95	Bansuri
96	Sitar
97	Detuned Sitar

Voice No.	Voice Name
98	Shehnai
99	Gopichant
100	Tabla
101	Indian Kit
102	Nay
103	Oud
104	Santur
105	Kanoon
106	Rabab
107	Arabic Kit
108	Kalimba
109	Trompeta Banda
110	Trombon Banda
111	Steel Drums
112	Cavaquinho
113	Zampoña
DRUM KIT	
114	Standard Kit
115	Brush Kit
116	Dance Kit
DUAL	
117	Octave Piano
118	Piano & Strings
119	Piano Pad
120	E.Piano Pad
121	Octave Harpsichord
122	Full Organ
123	Octave Strings
124	Octave Pizzicato
125	Strings & Flute
126	Strings Pad
127	Flute & Clarinet
128	Oboe & Bassoon
129	Alto Sax & Tenor Sax
130	Octave Brass
131	Power Brass
132	Jazz Section
133	Orchestra Tutti
134	Trumpet & Trombone
135	Fat Lead
136	Bell Mixture
137	Bell Pad
SPLIT	
138	Piano / A.Bass
139	E.Piano / E.Bass
140	Brass / Tuba
141	Trumpet / Trombone
142	Flute / Oboe / Clarinet / Bassoon
143	Soprano / Alto / Tenor / Baritone Sax
144	Trumpet / Horn / Trombone / Tuba

Drum Kit List / Liste der Drum Kits / Liste des kits de batterie / Lista de juegos de batería / Lista do conjunto de percussão / Elenco dei kit di batteria / Lijst met drumkits / Lista zestawów perkusyjnych / Liste over trommesæt / Lista över trumset / Seznam bicích sad / Zoznam bicích nástrojov / Dobkészletek listája / Seznam bobnov / Списък на набор от ударни инструменти / Listă Seturi de tobe / Bungu komplektu saraksts / Mušamujų rinkinio sąrašas / Trummikomplektide loend / Popis kompleta bubnjeva / Davul Seti Listesi / Danh sách bộ trống / قائمة مجموعة الآلات الإيقاعية

☐ : Same as "Standard Kit."
 ☐ : No Sound.

		No. 114	No. 115	No. 116	No. 101	No. 107
		Standard Kit	Brush Kit	Dance Kit	Indian Kit	Arabic Kit
C1	C 1	Finger Snap			Baya ge	Khaligi Clap 1
	C#1	C# 1	Brush Tap		Baya ke	Zarb Back mf
D1	D 1	Brush Swirl			Baya ghe	Khaligi Clap 2
	D#1	D# 1	Brush Slap		Baya ka	Arabic Zalgouta Close
E1	E 1	Brush Tap Swirl		Reverse Cymbal	Tabla na	Arabic Hand Clap
		F 1	Snare Roll		Tabla tin	Tabel Tak 1
F1	F#1	F# 1	Castanet		Tablabaya dha	Sagat 1
		G 1	Snare Soft	Brush Slap 2	Dhol 1 Open	Tabel Dom
	G#1	G# 1	Surdo Open		Dhol 1 Slap	Sagat 2
A1	A 1	Bass Drum Soft		Kick Techno Q	Dhol 1 Mute	Tabel Tak 2
	A#1	A# 1	Open Rim Shot	Rim Gate	Dhol 1 Open Slap	Sagat 3
B1	B 1	Bass Drum Hard		Kick Techno L	Dhol 1 Roll	Riq Tik 3
		C 2	Bass Drum	Bass Drum Jazz	Dandia Short	Riq Tik 2
	C#2	C# 2	Side Stick	Side Stick Analog	Dandia Long	Riq Tik Hard 1
D2	D#2	D 2	Snare	Brush Slap 3	Snare Clap	Chutki
		D# 2	Hand Clap		Chipri	Riq Tik Hard 2
E2	E 2	Snare Tight	Brush Tap	Snare Dry	Khanjira Open	Riq Tik Hard 3
		F 2	Floor Tom L	Tom Brush 1	Khanjira Slap	Riq Tish
F2	F#2	F# 2	Hi-Hat Closed	Hi-Hat Close Analog 1	Khanjira Mute	Riq Snouj 2
		G 2	Floor Tom H	Tom Brush 2	Khanjira Bendup	Riq Roll
	G#2	G# 2	Hi-Hat Pedal	Hi-Hat Close Analog 2	Khanjira Benddown	Riq Snouj 1
A2	A#2	A 2	Low Tom	Tom Brush 3	Hi-Hat Open Analog	Dholak 1 Open
		A# 2	Hi-Hat Open		Dholak 1 Mute	Riq Snouj 3
B2	B 2	Mid Tom L	Tom Brush 4	Tom Analog 4	Dholak 1 Slap	Riq Snouj 4
		C 3	Mid Tom H	Tom Brush 5	Tom Analog 5	Dhol 2 Open
	C#3	C# 3	Crash Cymbal 1		Cymbal Analog	Dhol 2 Slap
D3	D#3	D 3	High Tom	Tom Brush 6	Tom Analog 6	Dhol 2 Rim
		D# 3	Ride Cymbal 1			Hand Clap
E3	E 3	Chinese Cymbal				Mridangam din
		F 3	Ride Cymbal Cup			Mridangam ki
F3	F#3	F# 3	Tambourine			Mridangam ta
		G 3	Splash Cymbal			Dafli Open
	G#3	G# 3	Cowbell			Dafli Slap
A3	A#3	A 3	Crash Cymbal 2			Dafli Rim
		A# 3	Vibraslap			Chimta Normal
B3	B 3	Ride Cymbal 2				Chimta Ring
		C 4	Bongo H			Dholki Hi Open
	C#4	C# 4	Bongo L			Dholki Hi Mute
D4	D#4	D 4	Conga H Mute	Conga Analog H		Dholki Lo Open
		D# 4	Conga H Open	Conga Analog M		Dholki Hi Slap
E4	E 4	Conga L		Conga Analog L		Dholki Lo Slide
		F 4	Timbale H			Dholak 2 Open
F4	F#4	F# 4	Timbale L			Dholak 2 Slide
		G 4	Agogo H			Dholak 2 Rim 1
	G#4	G# 4	Agogo L			Dholak 2 Rim 2
A4	A#4	A 4	Cabasa			Dholak 2 Ring
		A# 4	Maracas			Jhanji Open
B4	B 4	Metronome Click				Dholak 2 Slap
		C 5	Metronome Bell			Mondira Open
	C#5	C# 5	Guiro Short			Mondira Close
D5	D#5	D 5	Guiro Long			Tabla C
		D# 5	Claves			Tabla F
E5	E 5	Wood Block H				Tabla G
		F 5	Wood Block L			Tabla B
F5	F#5	F# 5	Scratch H			Khomokh Normal
		G 5	Scratch L			Duff Open
	G#5	G# 5	Triangle Mute			Hatheli Long
A5	A#5	A 5	Triangle Open			Hatheli Short
		A# 5	Shaker			Thavil Slap
B5	B 5	Jingle Bells				Thavil Mute
		C 6	Bell Tree			Khartaal

		No. 114	No. 81	No. 82	No. 89		
		Standard Kit	Indonesian Kit 1	Indonesian Kit 2	Chinese Kit		
C1	C	1	Finger Snap				
	C#1	C#	1	Brush Tap			
D1	D	1	Brush Swirl				
	D#1	D#	1	Brush Slap			
E1	E	1	Brush Tap Swirl				
		F	1	Snare Roll			
F1	F#	1	Castanet				
	F#1	F#	1	Castanet			
G1	G	1	Snare Soft				
	G#1	G#	1	Surdo Open			
A1	A	1	Bass Drum Soft				
	A#1	A#	1	Open Rim Shot			
B1	B	1	Bass Drum Hard				
		C	2	Bass Drum			
C2	C#	2	Side Stick				
	C#2	C#	2	Side Stick			
D2	D	2	Snare				
	D#2	D#	2	Hand Clap			
E2	E	2	Snare Tight				
		F	2	Floor Tom L			
F2	F#	2	Hi-Hat Closed				
	F#2	F#	2	Hi-Hat Closed			
G2	G	2	Floor Tom H				
	G#2	G#	2	Hi-Hat Pedal			
A2	A	2	Low Tom				
	A#2	A#	2	Hi-Hat Open			
B2	B	2	Mid Tom L				
		C	3	Mid Tom H			
C3	C#	3	Crash Cymbal 1				
	C#3	C#	3	Crash Cymbal 1			
D3	D	3	High Tom				
	D#3	D#	3	Ride Cymbal 1			
E3	E	3	Chinese Cymbal				
		F	3	Ride Cymbal Cup			
F3	F#	3	Tambourine				
	F#3	F#	3	Tambourine			
G3	G	3	Splash Cymbal				
	G#3	G#	3	Cowbell			
A3	A	3	Crash Cymbal 2				
	A#3	A#	3	Vibraslap			
B3	B	3	Ride Cymbal 2				
		C	4	Bongo H	Kendang Ageng Dah	Tambourine Hit	
C4	C#	4	Bongo L	Kendang Tipung Thung 1	Tambourine Hit Mute		
	C#4	C#	4	Bongo L	Kendang Tipung Thung 1	Tambourine Hit Mute	
D4	D	4	Conga H Mute	Kendang Ciblon Dhen	Duf Open		
	D#4	D#	4	Conga H Open	Kendang Ciblon Det	Duf Slide	
E4	E	4	Conga L	Kendang Ciblon Thung	Duf Center Mute		
		F	4	Timbale H	Kendang Ciblon Lung 1	Duf Slap Mute	
F4	F#	4	Timbale L	Kendang Ciblon Thak 1	Duf Ring Mute		
	F#4	F#	4	Timbale L	Kendang Ciblon Thak 1	Duf Ring Mute	
G4	G	4	Agogo H	Kendang Ciblon Thak 2	Bayan Duf Open	Dagu Mute	
	G#4	G#	4	Agogo L	Kendang Tipung Thung 2	Bayan Duf Slap Mute	Zhongcha Mute
A4	A	4	Cabasa	Kendang Tipung Ket	Bayan Duf Slide	Dagu Heavy	
	A#4	A#	4	Maracas	Kendang Ciblon Lung 2	Bayan Duf Ring Mute	Zhongcha Open
B4	B	4	Metronome Click	Kendang Ciblon Tong	Dayan Finger Tips 4	Paigu Middle	
		C	5	Metronome Bell	Plak 1 Ring Mute	Tung Finger Tips 1	Paigu Low
C5	C#	5	Guiro Short	Guiro Center	Tung Finger Tips 2	Xiaocha Mute	
	C#5	C#	5	Guiro Short	Guiro Center	Tung Finger Tips 2	Xiaocha Mute
D5	D	5	Guiro Long	Tung Open 1	Dayan Finger Tips 1	Bangu	
	D#5	D#	5	Claves	Low Dut Open	Dayan Ring Mute	Xiaocha Open
E5	E	5	Wood Block H	Low Dut Mute 1	Dayan Finger Tips 3	Bangzi	
		F	5	Wood Block L	Low Dut Mute 2	Dayan Ring Open	Muyu Low
F5	F#	5	Scratch H	Low Dut Mute 3	Dayan Finger Tips 2	Zhongluo Mute	
	F#5	F#	5	Scratch H	Low Dut Mute 3	Dayan Finger Tips 2	Zhongluo Mute
G5	G	5	Scratch L	Low Dut Mute 4	Dayan Open	Muyu Mid-Low	
	G#5	G#	5	Triangle Mute	Low Dut Slide 1	Dayan Center Mute	Zhongluo Open
A5	A	5	Triangle Open	Low Dut Slide 2	Tung Open 2	Muyu Middle	
	A#5	A#	5	Shaker	Low Dut Slide 3	Plak 1 Mute Center	Xiaoluo Open
B5	B	5	Jingle Bells	Plak 2 Ring Open	Low Dut Mute 1	Triangle Mute	
		C	6	Bell Tree	Low Dut Mute 3	Triangle Open	

**Style List / Liste der Styles / Liste des styles / Lista de estilos / Lista de estilos /
 Elenco degli stili / Stijlijst / Lista stylów / Liste over stilarter / Lista över Styles /
 Seznam stylů / Zoznam štýlov / Stílusok listája / Seznam slogov / Списък със стилове /
 Listă de Stiluri / Stilu saraksts / Stilių sąrašas / Stiilide loend / Popis stilova /
 Tarz Listesi / Danh sách giai điệu / قائمة الإيقاعات**

Style No.	Style Name
POP & ROCK	
1	8Beat Modern
2	60s Guitar Pop
3	60s 8Beat
4	8Beat
5	Off Beat
6	60s Rock
7	Hard Rock
8	Rock Shuffle
9	8Beat Rock
10	16Beat
11	Pop Shuffle
12	Guitar Pop
13	16Beat Uptempo
14	Kool Shuffle
15	Hip Hop Light
BALLAD	
16	Piano Ballad
17	6/8 Modern EP
18	6/8 Slow Rock
19	Organ Ballad
20	Pop Ballad
21	16Beat Ballad
DANCE & DISCO	
22	EuroTrance
23	Ibiza
24	Swing House
25	Clubdance
26	Club Latin
27	Garage
28	Techno Party
29	Hip Hop Groove
30	70s Disco
31	Latin Disco
32	Saturday Night
33	Disco Hands
SWING & JAZZ	
34	Big Band Fast
35	Jazz Ballad
36	Jazz Club
37	Swing 1
38	Swing 2
39	Five/Four
40	Dixieland
41	Ragtime
R&B	
42	Soul
43	Detroit Pop
44	6/8 Soul

Style No.	Style Name
45	Croco Twist
46	Rock&Roll
47	Combo Boogie
48	6/8 Blues
COUNTRY	
49	Country Pop
50	Country Swing
51	Country 2/4
52	Bluegrass
BALLROOM	
53	Viennese Waltz
54	English Waltz
55	Slowfox
56	Foxtrot
57	Quickstep
58	Tango
59	Pasodoble
60	Samba
61	Cha Cha Cha
62	Rumba
63	Jive
TRAD & WALTZ	
64	March
65	6/8 March
66	Polka Pop
67	Tarantella
68	Showtune
69	Christmas Swing
70	Christmas Waltz
71	Waltz
72	Swing Waltz
73	Jazz Waltz
74	Country Waltz
75	Musette
WORLD	
76	Hawaiian
77	Scottish Reel
78	Celtic Dance
79	Modern Dangdut 1
80	Keroncong
81	Modern Dangdut 2
82	Dangdut Umum
83	Dangdut Slow Legend
84	Dangdut 3/4
85	Langgam Modern
86	Dangdut Jawa
87	Vietnamese Pop Ballad
88	Vietnamese 6/8 Ballad

Style No.	Style Name
89	Xi Qing Luo Gu
90	Yi Zu Min Ge
91	Jing Ju Jie Zou
92	Kung Fu
93	Zhong Guo Gu Qu
94	Xin Jiang Min Ge
95	China Funk
96	China Pop Ballad
97	China Dance
98	China 6/8 Slow Rock
99	Bhajan
100	Bolly Mix
101	Indian Pop
102	Hind Ballad
103	Indy Waltz
104	Bhangra
105	Kerala
106	Rajasthan
107	Dandiya
108	Qawwali
109	Saeidy
110	Wehda Saghira
111	Laff
112	Emarati
113	Iranian Elec
114	Kordi Pop
115	Bandari
116	Fazzani
117	4/4 Standart
118	Rumba 2/4
119	African Gospel Reggae
120	High Life 1
121	African Gospel
122	Makossa
123	Modern Afrobeat
124	High Life 2
125	Organ High Life
126	Igbo High Life
127	Soca
128	Azonto
129	Brazilian Samba
130	Bossa Nova
131	Forro
132	Sertanejo
133	Baião
134	Joropo
135	Parranda
136	Tango Argentino
137	Cumbia Peruana

Style No.	Style Name
138	Cumbia Colombiana
139	Vallenato
140	Reggaeton Pop
141	Merengue
142	Mambo
143	Salsa
144	Beguine
145	Reggae
146	Tijuana
147	Paso Duranguense
148	Cumbia Grupera
149	Balada Banda
150	Mexican Mambo
PIANIST	
151	Stride
152	Piano Swing
153	Arpeggio
154	Habanera
155	Slow Rock
156	8Beat Piano Ballad
157	6/8 Piano March
158	Piano Waltz

**Song List / Liste der Songs / Liste des morceaux / Lista de canciones /
 Lista de músicas / Elenco delle song / Songoverzicht / Lista utworów /
 Liste over melodier / Lista över Songer / Seznam skladeb / Zoznam skladieb /
 Zenedarabok listája / Seznam pesmi / Списък с песни / Listă de Cântece /
 Dziesmu saraksts / Kūrīnių sąrašas / Lugude loend / Popis pjesama / Şarkı Listesi /
 Danh sách bài hát / قائمة الأغاني**

Song No.	Song Name	Composer
DEMO		
001	DEMO	Yamaha Original
CHILDREN'S SONG		
002	Frère Jacques	Traditional
003	Der Froschgesang	Traditional
004	London Bridge	Traditional
005	Sur le pont d'Avignon	Traditional
006	Nedelka	Traditional
007	Sippin' Cider Through a Straw	Traditional
008	Old MacDonald Had A Farm	Traditional
009	If You're Happy and You Know It	Traditional
010	Yankee Doodle	Traditional
FAVORITE		
011	Aura Lee	Traditional
012	Bury Me Not on the Lone Prairie	Traditional
013	Kalinka	Traditional
014	Holdilia Cook	Traditional
015	La Cucaracha	Traditional
016	Aloha Oe	Q. Liliuokalani
017	Old Folks at Home	S. C. Foster
018	Santa Lucia	A. Longo
019	Beautiful Dreamer	S. C. Foster
020	Ring de Banjo	S. C. Foster
021	Romance de Amor	Traditional
022	Amazing Grace	Traditional
023	Oh! Susanna	S. C. Foster
024	Joy to the World	G. F. Händel
025	When the Saints Go Marching In	Traditional
026	Battle Hymn of the Republic	Traditional
CLASSIC		
027	Largo (from the New World)	A. Dvořák
028	Brahms' Lullaby	J. Brahms
029	Chanson du Toreador	G. Bizet
030	Jupiter, the Bringer of Jollity	G. Holst
031	Salut d'Amour op.12	E. Elgar
032	Symphony No.9 (from the New World - 4th movement)	A. Dvořák
033	Serenade for Strings in C major, op.48	P. I. Tchaikovsky
034	The Danube Waves	I. Ivanovici
DUET		
035	Ten Little Indians	Traditional
036	The Cuckoo	Traditional
037	O du lieber Augustin	Traditional
038	Twinkle Twinkle Little Star	Traditional
039	Im Mai	Traditional
040	O Christmas Tree	Traditional
041	Pop Goes The Weasel	Traditional

Song No.	Song Name	Composer
042	Mary Had a Little Lamb	Traditional
043	Row Row Row Your Boat	Traditional
044	On Top of Old Smoky	Traditional
PIANO ENSEMBLE		
045	Little Brown Jug	Traditional
046	Auld Lang Syne	Traditional
047	Wenn ich ein Vöglein wär	Traditional
048	Die Lorelei	F. Silcher
049	Home Sweet Home	H. R. Bishop
050	Scarborough Fair	Traditional
051	My Old Kentucky Home	Traditional
052	Loch Lomond	Traditional
053	Silent Night	F. Gruber
054	Deck the Halls	Traditional
055	O Christmas Tree	Traditional
056	Sonata Pathétique 2nd Adagio Cantabile	L. v. Beethoven
057	Ave Maria/J. S. Bach - Gounod	J. S. Bach / C. F. Gounod
058	Jesus bleibet meine Freude	J. S. Bach
059	Prelude op.28-15 "Raindrop"	F. Chopin
060	Nocturne op.9-2	F. Chopin
061	Etude op.10-3 "Chanson de L'adieu"	F. Chopin
062	Romanze (Serenade K.525)	W. A. Mozart
PIANO SOLO		
063	Arabesque	J. F. Burgmüller
064	La Chevaleresque	J. F. Burgmüller
065	Für Elise	L. v. Beethoven
066	Turkish March	W. A. Mozart
067	24 Preludes op.28-7	F. Chopin
068	Annie Laurie	Traditional
069	Jeanie with the Light Brown Hair	S. C. Foster

**Smart Chord Chart / Tabelle der Smart Chords / Tableau Smart Chord /
 Tabla de Smart Chords (acordes inteligentes) / Tabela de Smart Chord /
 Grafico Smart Chord / Smart Chord-overzicht / Tablica inteligentnych akordów /
 Smart Chord-skema / Smart Chord-diagram / Tabulka inteligentních akordů /
 Tabuľka funkcie inteligentné akordy / Intelligens akkordok táblázata /
 Tabela pametnih akordov / Диаграма на интелигентен акорд / Diagramă acord inteligent /
 Viedo akordu diagramma / Sumariojo akordų parinkimo lentelė / Nutika akordi tabel /
 Tablica inteligentnih akorda / Akıllı Akor Çizelgesi / Biểu đồ hợp âm thông minh /
 جدول النغمات المتألفة الذكية**

When the Fingering Type is set to "Smart Chord (577-)", if you set the Smart Chord Key (page 9) according to the score, make sure to the root note of the chord in the Auto Accompaniment range. This lets you hear the respective chords below.

Key Signature on the music score	Display (Smart Chord Key)	Notes to be played (Root Note)													
		C#/D♭			D#/E♭			F#/G♭			G#/A♭			A#/B♭	
		C	D	E	F	G	A	B							
	FL7	C dim	D♭ m	E♭♭ dim7	E♭ 1+5	F♭	F dim	G♭ 7	A♭♭	A♭ m	B♭♭	B♭ m7♭5	C♭		
	FL6	C dim	D♭ 7	E♭♭	E♭ m	F♭	F m7♭5	G♭	G dim	A♭ m	B♭♭ dim7	B♭ 1+5	C♭		
	FL5	C m7♭5	D♭	D dim	E♭ m	F♭ dim7	F 1+5	G♭	G dim	A♭ 7	B♭♭	B♭ m	C♭		
	FL4	C 1+5	D♭	D dim	E♭ 7	F♭	F m	G♭	G m7♭5	A♭	A dim	B♭ m	C♭ dim7		
	FL3	C m	D♭	D m7♭5	E♭	E dim	F m	G♭ dim7	G 1+5	A♭	A dim	B♭ 7	C♭		
	FL2	C m	D♭ dim7	D 1+5	E♭	E dim	F 7	G♭	G m	A♭	A m7♭5	B♭	B dim		
	FL1	C 7	D♭	D m	E♭	E m7♭5	F	F# dim	G m	A♭ dim7	A 1+5	B♭	B dim		
No key signature 	SP0 (Default)	C	C# dim	D m	E♭ dim7	E 1+5	F	F# dim	G 7	A♭	A m	B♭	B m7♭5		
	SP1	C	C# dim	D 7	E♭	E m	F	F# m7♭5	G	G# dim	A m	B♭ dim7	B 1+5		
	SP2	C	C# m7♭5	D	D# dim	E m	F dim7	F# 1+5	G	G# dim	A 7	B♭	B m		
	SP3	C dim7	C# 1+5	D	D# dim	E 7	F	F# m	G	G# m7♭5	A	A# dim	B m		
	SP4	C	C# m	D	D# m7♭5	E	E# dim	F# m	G dim7	G# 1+5	A	A# dim	B 7		
	SP5	B# dim	C# m	D dim7	D# 1+5	E	E# dim	F# 7	G	G# m	A	A# m7♭5	B		
	SP6	B# dim	C# 7	D	D# m	E	E# m7♭5	F#	F× dim	G# m	A dim7	A# 1+5	B		
	SP7	B# m7♭5	C#	C× dim	D# m	E dim7	E# 1+5	F#	F× dim	G# 7	A	A# m	B		

Reading the Score

Use this handy guide to learn how to read the score and practice the Songs in the Song Book (page 5)!

◇ Finger Numbering

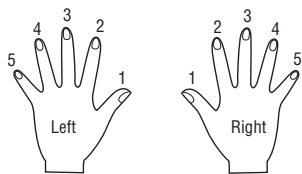

◇ The Keyboard, Staff Lines, and Clef

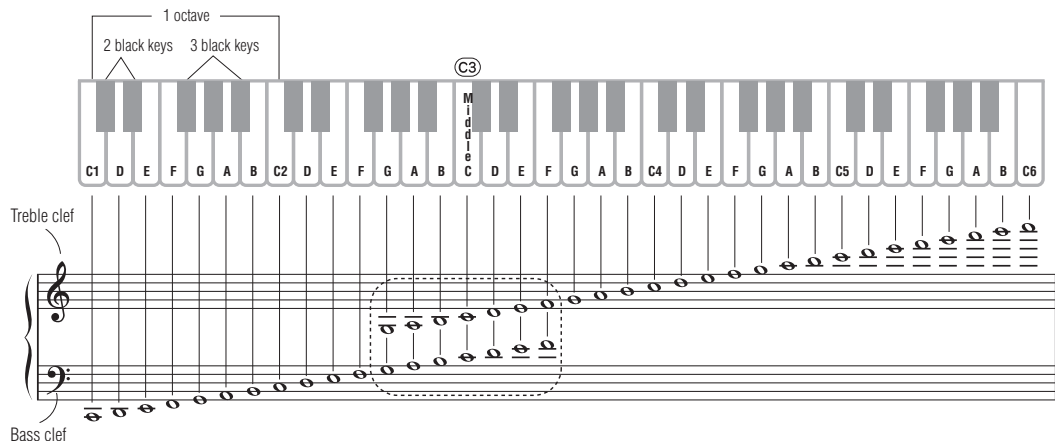

◇ Notes and Rests

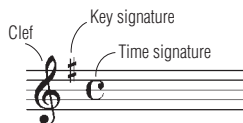

Whole note		1 2 3 4	Whole note rest	
Dotted half note		1 2 3 4	Dotted half note rest	
Half note		1 2	Half note rest	
Dotted quarter note		1 2 3 4	Dotted quarter note rest	
Quarter note		1 2 3 4	Quarter note rest	
Eighth note		1 2 3 4	Eighth note rest	
Sixteenth note		1 2 3 4	Sixteenth note rest	

◇ Accidentals

- # (Sharp) Raise a semitone
- b (Flat) Lower a semitone
- ♮ (Natural) Return to normal pitch

◇ Time Signatures and Counting Time

4/4 time



2/2 time



6/8 time

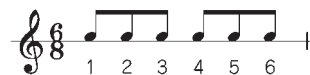

◇ Repeats

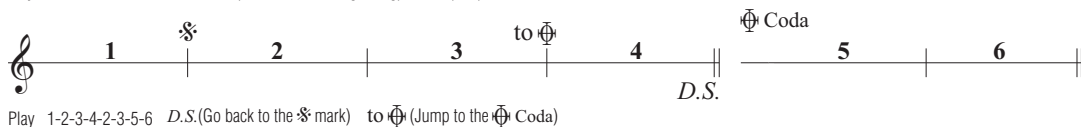
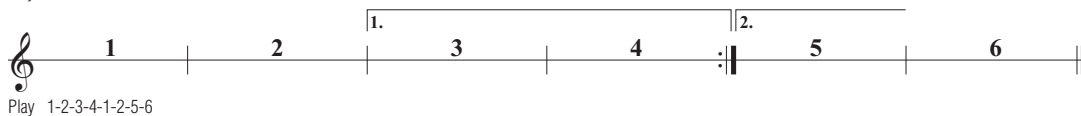



**Important Notice:
U.S. LIMITED WARRANTY for Customers in the United States**

For detailed information about this Yamaha product and warranty service, please either visit the following website address (printable file is available at our website) or contact Customer Service at the address or telephone number identified below.

Website Address:

Yamaha.io/pkbwarranty

Customer Service:

Yamaha Corporation of America
6600 Orangethorpe Avenue, Buena Park, CA 90620-1273
Telephone: 800-854-1569

Important Notice: Guarantee Information for customers in EEA* and Switzerland (EEA) and Switzerland

<p>Important Notice: Guarantee Information for customers in EEA* and Switzerland For detailed guarantee information about this Yamaha product, and Pan-EEA* and Switzerland warranty service, please either visit the website address below (Printable file is available at our website) or contact the Yamaha representative office for your country. * EEA: European Economic Area</p>	<p>English</p>
<p>Wichtiger Hinweis: Garantie-Information für Kunden in der EWR* und der Schweiz Für nähere Garantie-Information über dieses Produkt von Yamaha, sowie über den Pan-EWR*- und Schweizer Garantieservice, besuchen Sie bitte entweder die folgend angegebene Internetadresse (eine druckfähige Version befindet sich auch auf unserer Webseite), oder wenden Sie sich an den für Ihr Land zuständigen Yamaha-Vertrieb. *EWR: Europäischer Wirtschaftsraum</p>	<p>Deutsch</p>
<p>Remarque importante: informations de garantie pour les clients de l'EEE* et la Suisse Pour des informations plus détaillées sur la garantie de ce produit Yamaha et sur le service de garantie applicable dans l'ensemble de l'EEE ainsi qu'en Suisse, consultez notre site Web à l'adresse ci-dessous (le fichier imprimable est disponible sur notre site Web) ou contactez directement Yamaha dans votre pays de résidence. * EEE : Espace Economique Européen</p>	<p>Français</p>
<p>Belangrijke mededeling: Garantie-informatie voor klanten in de EER* en Zwitserland Voor gedetailleerde garantie-informatie over dit Yamaha-product en de garantieservice in heel de EER* en Zwitserland, gaat u naar de onderstaande website (u vind een afdrukbaar bestand op onze website) of neemt u contact op met de vertegenwoordiging van Yamaha in uw land. * EER: Europese Economische Ruimte</p>	<p>Nederlands</p>
<p>Aviso importante: información sobre la garantía para los clientes del EEE* y Suiza Para una información detallada sobre este producto Yamaha y sobre el soporte de garantía en la zona EEE* y Suiza, visite la dirección web que se incluye más abajo (la versión del archivo para imprimir esta disponible en nuestro sitio web) o póngase en contacto con el representante de Yamaha en su país. * EEE: Espacio Económico Europeo</p>	<p>Español</p>
<p>Aviso importante: informazioni sulla garanzia per i clienti residenti nell'EEA* e in Svizzera Per informazioni dettagliate sulla garanzia relativa a questo prodotto Yamaha e l'assistenza in garanzia nei paesi EEA* e in Svizzera, potete consultare il sito Web all'indirizzo riportato di seguito (è disponibile il file in formato stampabile) oppure contattare l'ufficio di rappresentanza locale della Yamaha. * EEA: Area Economica Europea</p>	<p>Italiano</p>
<p>Aviso importante: informações sobre as garantias para clientes da AEE* e da Suíça Para obter uma informação pormenorizada sobre este produto da Yamaha e sobre o serviço de garantia na AEE* e na Suíça, visite o site a seguir (o arquivo para impressão está disponível no nosso site) ou entre em contato com o escritório de representação da Yamaha no seu país. * AEE: Área Económica Europeia</p>	<p>Português</p>
<p>Σημαντική σημείωση: Πληροφορίες εγγύησης για τους πελάτες στον ΕΟΧ* και Ελλάδα Για λεπτομερείς πληροφορίες εγγύησης σχετικά με το προϊόν της Yamaha και την κάλυψη εγγύησης σε όλη τις χώρες του ΕΟΧ και την Ελλάδα, επισκεφτείτε την παρακάτω ιστοσελίδα (Εκτυπώσιμη μορφή είναι διαθέσιμη στην ιστοσελίδα μας) ή απευθυνθείτε στην αντιπροσωπεία της Yamaha στη χώρα σας. * ΕΟΧ: Ευρωπαϊκός Οικονομικός Χώρος</p>	<p>Ελληνικά</p>
<p>Viktigt: Garantiinformation för kunder i EES-området* och Schweiz För detaljerad information om denna Yamaha-produkt samt garantireservice i hela EES-området* och Schweiz kan du antingen besöka nedanstående webbadress (en utskriftsvänlig fil finns på webbplatsen) eller kontakta Yamahas officiella representant i ditt land. * EES: Europeiska Ekonomiska Samarbetsområdet</p>	<p>Svenska</p>
<p>Viktig merknad: Garantiinformasjon for kunder i EØS* og Sveits Detaljert garantiinformasjon om dette Yamaha-produktet og garantireservice for hele EØS-området* og Sveits kan fås enten ved å besøke nettstedene nedenfor (utskriftsversjon finnes på våre nettsider) eller kontakte kontakte Yamaha-kontoret i landet der du bor. *EØS: Det europeiske økonomiske samarbeidsområdet</p>	<p>Norsk</p>
<p>Vigtig oplysning: Garantiplysninger til kunder i EØO* og Schweiz De kan finde detaljerede garantiplysninger om dette Yamaha-produkt og den fælles garantireserviceordning for EØO* (og Schweiz) ved at besøge det websted, der er angivet nedenfor (der findes en fil, som kan udskrives, på vores websted), eller ved at kontakte Yamahas nationale repræsentationskontor i det land, hvor De bor. * EØO: Det Europæiske Økonomiske Område</p>	<p>Dansk</p>

<p>Tärkeä ilmoitus: Taku tiedot Euroopan talousalueen (ETA)* ja Sveitsin asiakkaille Tämän Yamaha-tuotteen sekä ETA-alueen ja Sveitsin takuuta koskevat yksityiskohtaiset tiedot saatte alla olevasta nettiosoitteesta. (Tulostettava tiedosto saatavissa sivustollamme.) Voitte myös ottaa yhteyttä paikalliseen Yamaha-edustajaan. *ETA: Euroopan talousalue</p>	<p>Suomi</p>
<p>Ważne: Warunki gwarancyjne obowiązujące w EOG* i Szwajcarii Aby dowiedzieć się więcej na temat warunków gwarancyjnych tego produktu firmy Yamaha i serwisu gwarancyjnego w całym EOG* i Szwajcarii, należy odwiedzić wskazaną poniżej stronę internetową (Plik gotowy do wydruku znajduje się na naszej stronie internetowej) lub skontaktować się z przedstawicielstwem firmy Yamaha w swoim kraju. * EOG — Europejski Obszar Gospodarczy</p>	<p>Polski</p>
<p>Důležité oznámení: Zásadní informace pro zákazníky v EHS* a ve Švýcarsku Podrobné zásadní informace o tomto produktu Yamaha a záručním servisu v celém EHS* a ve Švýcarsku naleznete na níže uvedené webové adrese (soubor k tisku je dostupný na našich webových stránkách) nebo se můžete obrátit na zastoupení firmy Yamaha ve své zemi. * EHS: Evropský hospodářský prostor</p>	<p>Česky</p>
<p>Fontos figyelmeztetés: Garancia-információk az EGT* területén és Svájcban élő vásárlók számára A jelen Yámaha termékre vonatkozó részletes garancia-információk, valamint az EGT*-re és Svájcra kiterjedő garanciális szolgáltatás tekintetében keressse fel webhelyünket az alábbi címen (a webhelyen nyomtatható fájl is talál), vagy pedig lépjen kapcsolatba az országában működő Yamaha képviselői irodával. * EGT: Európai Gazdasági Térség</p>	<p>Magyar</p>
<p>Oluline märkus: Garantiiteave Euroopa Majanduspiirkonna (EMP)* ja Šveitsi klientidele Täpsema teabe saamiseks selle Yamaha toote garantii ning kogu Euroopa Majanduspiirkonnaja Šveitsi garantiiteeninduse kohta, külastage palun veebisaiti alljärgneval aadressil (meie saidil on saadaval printitav fail) või pöörduge Teie riigioni Yamaha esinduse poole. * EMP: Euroopa Majanduspiirkond</p>	<p>Eesti keel</p>
<p>Svarigs paziņojums: Garantijas informācija klientiem EEZ* un Šveicā Lai saņemtu detalizētu garantijas informāciju par šo Yamaha produktu, kā arī garantijas apkalpošanu EEZ* un Šveicā, lūdzu apmeklētiet zemāk norādīto tīmekļa vietnes adresi (tīmekļa vietnē ir pieejams drukājams fails) vai sazināties ar jūsu valstī apkalpojošo Yamaha pārstāvniecību. * EEZ: Eiropas Ekonomikas zona</p>	<p>Latviešu</p>
<p>Dėmesio: informacija dėl garantijos pirkėjams EEE* ir Šveicarijoje Jei reikia išsamios informacijos apie šį „Yamaha“ produktą ir jo techninę priežiūrą visoje EEE* ir Šveicarijoje, apsilankykite mūsų svetainėje toliau nurodytu adresu (svetainėje yra spausdinamas failas) arba kreipkitės į „Yamaha“ atstovybę savo šaliai. *EEE – Europos ekonominė erdvė</p>	<p>Lietuvių kalba</p>
<p>Dôležité upozornenie: Informácie o záruke pre zákazníkov v EHP* a Švajčiarsku Podrobné informácie o záruke týkajúce sa tohto produktu od spoločnosti Yamaha a garancnom servise v EHP* a Švajčiarsku nájdete na webovej stránke uvedenej nižšie (na našej webovej stránke je k dispozícii súbor na tlač) alebo sa obráťte na zástupcu spoločnosti Yamaha vo svojej krajine. * EHP: Európsky hospodársky priestor</p>	<p>Slovenčina</p>
<p>Pomembno obvestilo: Informacije o garanciji za kupce v EGP* in Švici Za podrobnejše informacije o tem Yamahinem izdelku ter garancijskem servisu v celotnem EGP in Švici, obiščite spletno mesto, ki je navedeno spodaj (natisljiva datoteka je na voljo na našem spletnem mestu), ali se obrnite na Yamahinega predstavnika v svoji državi. * EGP: Evropski gospodarski prostor</p>	<p>Slovenščina</p>
<p>Важно съобщение: Информация за гаранцията за клиенти в ЕИП* и Швейцария За подробна информация за гаранцията за този продукт на Yamaha и гаранционното обслужване в паневропейската зона на ЕИП* и Швейцария или посетете посочения по-долу уеб сайт (на нашия уеб сайт има файл за печат), или се свържете с представителния офис на Yamaha във вашата страна. * ЕИП: Европейско икономическо пространство</p>	<p>Български език</p>
<p>Notificarea importantă: Informații despre garanție pentru clienții din SEE* și Elveția Pentru informații detaliate privind acest produs Yamaha și serviciul de garanție Pan-SEE* și Elveția, vizitați site-ul la adresa de mai jos (fișierul imprimabil este disponibil pe site-ul nostru) sau contactați biroul reprezentanței Yamaha din țara dumneavoastră. * SEE: Spațiul Economic European</p>	<p>Limba română</p>
<p>Važna obavijest: Informacije o jamstvu za države EGP-a i Švicarske Za detaljne informacije o jamstvu za ovaj Yamahin proizvod te jamstvenom servisu za cijeli EGP i Švicarsku, molimo Vas da posjetite web-stranicu navedenu u nastavku ili kontaktirate ovlaštenog Yamahinog dobavljača u svojoj zemlji. * EGP: Europski gospodarski prostor</p>	<p>Hrvatski</p>

NORTH AMERICA

CANADA

Yamaha Canada Music Ltd.
135 Milner Avenue, Toronto, Ontario M1S 3R1,
Canada
Tel: +1-416-298-1311

U.S.A.

Yamaha Corporation of America
6600 Orangethorpe Avenue, Buena Park, CA 90620,
U.S.A.
Tel: +1-714-522-9011

CENTRAL & SOUTH AMERICA

MEXICO

Yamaha de México, S.A. de C.V.
Av. Insurgentes Sur 1647 Piso 9, Col. San José
Insurgentes, Delegación Benito Juárez, CDMX,
C.P. 03900, México
Tel: +52-55-5804-0600

BRAZIL

Yamaha Musical do Brasil Ltda.
Praça Professor José Lannes, 40, Cjs 21 e 22, Brooklin
Paulista Novo CEP 04571-100 – São Paulo – SP,
Brazil
Tel: +55-11-3704-1377

ARGENTINA

**Yamaha Music Latin America, S.A.,
Sucursal Argentina**
Olga Cossetini 1553, Piso 4 Norte,
Madero Este-C1107CEK,
Buenos Aires, Argentina
Tel: +54-11-4119-7000

PANAMA AND OTHER LATIN

AMERICAN REGIONS/ CARIBBEAN REGIONS

Yamaha Music Latin America, S.A.
Edificio Torre Davivienda, Piso: 20
Avenida Balboa, Marbella, Corregimiento de Bella
Vista, Ciudad de Panamá, Rep. de Panamá
Tel: +507-269-5311

EUROPE

THE UNITED KINGDOM/IRELAND

Yamaha Music Europe GmbH (UK)
Sherbourne Drive, Tilbrook, Milton Keynes,
MK7 8BL, U.K.
Tel: +44-1908-366700

GERMANY

Yamaha Music Europe GmbH
Siemensstrasse 22-34, 25462 Rellingen, Germany
Tel: +49-4101-303-0

SWITZERLAND/LIECHTENSTEIN

**Yamaha Music Europe GmbH, Branch
Switzerland in Thalwil**
Seestrasse 18a, 8800 Thalwil, Switzerland
Tel: +41-44-3878080

AUSTRIA/CROATIA/CZECH REPUBLIC/ HUNGARY/ROMANIA/SLOVAKIA/ SLOVENIA

Yamaha Music Europe GmbH, Branch Austria
Schleiergasse 20, 1100 Wien, Austria
Tel: +43-1-60203900

POLAND

**Yamaha Music Europe
Sp.z o.o. Oddział w Polsce**
ul. Wielicka 52, 02-657 Warszawa, Poland
Tel: +48-22-880-08-88

BULGARIA

Dinacord Bulgaria LTD.
Bul.Iskarsko Schose 7 Targowski Zentar Ewropa
1528 Sofia, Bulgaria
Tel: +359-2-978-20-25

MALTA

Olimpus Music Ltd.
Valletta Road, Mosta MST9010, Malta
Tel: +356-2133-2093

NETHERLANDS/BELGIUM/ LUXEMBOURG

Yamaha Music Europe, Branch Benelux
Clarissenhof 5b, 4133 AB Vianen, The Netherlands
Tel: +31-347-358040

FRANCE

Yamaha Music Europe
7 rue Ambroise Croizat, Zone d'activités de Pariest,
77183 Croissy-Beaubourg, France
Tel: +33-1-6461-4000

ITALY

Yamaha Music Europe GmbH, Branch Italy
Via Tinelli N.67/69 20855 Gerno di Lesmo (MB),
Italy
Tel: +39-039-9065-1

SPAIN/PORTUGAL

**Yamaha Music Europe GmbH Ibérica, Sucursal
en España**
Ctra. de la Coruña km. 17.200, 28231
Las Rozas de Madrid, Spain
Tel: +34-91-639-88-88

GREECE

Philippos Nakas S.A. The Music House
19th klm. Leof. Lavriou 190 02 Peania – Attiki,
Greece
Tel: +30-210-6686260

SWEDEN

**Yamaha Music Europe GmbH Germany filial
Scandinavia**
JA Wettergrensgata 1, 400 43 Göteborg, Sweden
Tel: +46-31-89-34-00

DENMARK

**Yamaha Music Denmark,
Filial of Yamaha Music Europe GmbH, Tyskland**
Generatorvej 8C, ST. TH., 2860 Søborg, Denmark
Tel: +45-44-92-49-00

FINLAND

F-Musiikki Oy
Antaksentie 4
FI-01510 Vantaa, Finland
Tel: +358 (0)96185111

NORWAY

**Yamaha Music Europe GmbH Germany -
Norwegian Branch**
Grini Næringspark 1, 1332 Østerås, Norway
Tel: +47-6716-7800

ICELAND

Hljodfaerahusid Ehf.
Sidumula 20
IS-108 Reykjavik, Iceland
Tel: +354-525-5050

CYPRUS

Nakas Music Cyprus Ltd.
Nikis Ave 2k
1086 Nicosia
Tel: + 357-22-511080
Major Music Center
21 Ali Riza Ave. Ortakoy
P.O.Box 475 Lefkoşa, Cyprus
Tel: (392) 227 9213

RUSSIA

Yamaha Music (Russia) LLC.
Room 37, entrance 7, bld. 7, Kievskaya street,
Moscow, 121059, Russia
Tel: +7-495-626-5005

OTHER EUROPEAN REGIONS

Yamaha Music Europe GmbH
Siemensstrasse 22-34, 25462 Rellingen, Germany
Tel: +49-4101-303-0

AFRICA

Yamaha Music Gulf FZE
JAFZA-16, Office 512, P.O.Box 17328,
Jebel Ali FZE, Dubai, UAE
Tel: +971-4-801-1500

MIDDLE EAST

TURKEY

**Yamaha Music Europe GmbH
Merkezi Almanya Türkiye İstanbul Şubesi**
Mor Sumbul Sokak Varyap Meridian Business
I.Blok No:1 113-114-115
Bati Atasehir Istanbul, Turkey
Tel: +90-216-275-7960

ISRAEL

RBX International Co., Ltd.
P.O Box 10245, Petach-Tikva, 49002
Tel: (972) 3-925-6900

OTHER REGIONS

Yamaha Music Gulf FZE
JAFZA-16, Office 512, P.O.Box 17328,
Jebel Ali FZE, Dubai, UAE
Tel: +971-4-801-1500

ASIA

THE PEOPLE'S REPUBLIC OF CHINA

Yamaha Music & Electronics (China) Co., Ltd.
2F, Yunhedasha, 1818 Xinzha-lu, Jingan-qu,
Shanghai, China
Tel: +86-400-051-7700

HONG KONG

Tom Lee Music Co., Ltd.
11/F, Silvercord Tower 1, 30 Canton Road,
Tsimshatsui, Kowloon, Hong Kong
Tel: +852-2737-7688

INDIA

Yamaha Music India Private Limited
P-401, JMD Megapolis, Sector-48, Sohna Road,
Gurugram-122018, Haryana, India
Tel: +91-124-485-3300

INDONESIA

PT Yamaha Musik Indonesia Distributor
Yamaha Music Center Bldg. Jalan Jend. Gatot
Subroto Kav. 4, Jakarta 12930, Indonesia
Tel: +62-21-520-2577

KOREA

Yamaha Music Korea Ltd.
11F, Prudential Tower, 298, Gangnam-daero,
Gangnam-gu, Seoul, 06253, Korea
Tel: +82-2-3467-3300

MALAYSIA

Yamaha Music (Malaysia) Sdn. Bhd.
No.8, Jalan Perbandaran, Kelana Jaya, 47301
Petaling Jaya, Selangor, Malaysia
Tel: +60-3-78030900

SINGAPORE

Yamaha Music (Asia) Private Limited
Block 202 Hougang Street 21, #02-00,
Singapore 530202, Singapore
Tel: +65-6740-9200

TAIWAN

Yamaha Music & Electronics Taiwan Co., Ltd.
2F, No. 1, Yuandong Rd., Banqiao Dist.,
New Taipei City 22063, Taiwan (R.O.C.)
Tel: +886-2-7741-8888

THAILAND

Siam Music Yamaha Co., Ltd.
3, 4, 15, 16th Fl., Siam Motors Building,
891/1 Rama 1 Road, Wangmai,
Pathumwan, Bangkok 10330, Thailand
Tel: +66-2215-2622

VIETNAM

Yamaha Music Vietnam Company Limited
15th Floor, Nam A Bank Tower, 201-203 Cach
Mang Thang Tam St., Ward 4, Dist.3,
Ho Chi Minh City, Vietnam
Tel: +84-28-3818-1122

OTHER ASIAN REGIONS

[https://asia-latinamerica-mea.yamaha.com/
index.html](https://asia-latinamerica-mea.yamaha.com/index.html)

OCEANIA

AUSTRALIA

Yamaha Music Australia Pty. Ltd.
Level 1, 80 Market Street, South Melbourne,
VIC 3205 Australia
Tel: +61-3-9693-5111

NEW ZEALAND

Music Works LTD
P.O.BOX 6246 Wellesley, Auckland 4680,
New Zealand
Tel: +64-9-634-0099

REGIONS AND TRUST

TERRITORIES IN PACIFIC OCEAN

[https://asia-latinamerica-mea.yamaha.com/
index.html](https://asia-latinamerica-mea.yamaha.com/index.html)

Head Office/Manufacturer: Yamaha Corporation 10-1, Nakazawa-cho, Naka-ku, Hamamatsu, 430-8650, Japan

DMI29

Importer (European Union): Yamaha Music Europe GmbH Siemensstrasse 22-34, 25462 Rellingen, Germany

Importer (United Kingdom): Yamaha Music Europe GmbH (UK) Sherbourne Drive, Tilbrook, Milton Keynes, MK7 8BL, United Kingdom

Yamaha Global Site
<https://www.yamaha.com/>

Yamaha Downloads
<https://download.yamaha.com/>

Manual Development Group
© 2021 Yamaha Corporation
Published 06/2021 POES-A0

VEJ2000